



# HG-MCCB

Molded Case Circuit Breakers & Earth Leakage Circuit Breakers



## Essential for Today, Potential for Tomorrow

Hyundai Electric solely pursues the growth of our customers' business. From power generation to power distribution, we focus on developing and commercializing products and solutions aimed at increasing the efficiency of energy equipment as well as at proactively monitoring and controlling assets in an integrated manner to improve our customers' productivity and management efficiency. We are well aware that our efforts add to the driving force behind our customers' growth and contribute to the creation and maintenance of a more dynamic world. We focus on achieving innovation and strive to evolve continuously to shape a better tomorrow based on today's technological advancement

# Solution

## Generation

Power Plants

## Utility

### INTEGRICT

#### Energy Solution

Energy solution business refers to the business of designing, procuring and establishing a system that enables the efficient use of power energy through integrated management of the production, consumption, sales and operation of energy.



#### Asset Management Solution

Asset management solution is a business that maximizes the overall business efficiency by systematically managing the performance, risk, maintenance cost and others as well as by providing an asset management solution suitable to the customer's circumstance depending on the product lifecycle (PLC) of various products.

#### Primary Substation

- Supplied more than 1.2 million MVA in total to 70 countries around the world for the past 40 over years since 1978
- Satisfies the various demands of customers through the acquisition of quality certifications from international accredited institute
- Participates in the world's key technical committee such as CIGRE and others, pioneering the establishment of technology standard related to power network

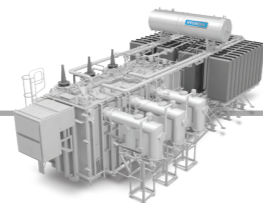

##### Power Transformer

· up to 800 kV, 1,500 MVA

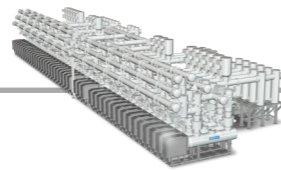

##### Gas Insulated Switchgear

· up to 800 kV

#### Secondary Substation

- Can be installed in spaces smaller than the open type of substation by using SF6 gas with outstanding insulation and arc extinguishing characteristics
- Secures advanced reliability by producing products that are resistant to external environment and climate effects through the sealing at the charge part
- Extensive project experiences around the world
- Reduces installation period and cost due to simple installation and transportation, convenient maintenance
- Design considering the safety of the workers as priority



##### Gas Insulated Switchgear

· GIS for 245 ~ 550 kV



##### Power Transformer

· 800 kV, 1,500 MVA



##### Gas Insulated Switchgear

· GIS for 170 kV



##### Generators



##### Generators

· 2-4 pole



##### Synchronous Generator

· 100 ~ 50,000 kVA  
· 220 ~ 22,000 V, 50/60 Hz  
· over 4 pole



##### Wind Turbine Generator

· up to 5 MW

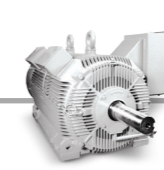

##### H+C Series Motor

· 150-1,300 HP  
· 2,000 ~ 7,200 V, 50/60 Hz  
· 2-8 pole

## Distribution



##### Cubicle GIS

· up to 38 kV

- Produces high quality products using angle-less type
- Multi-functional digital protection relay (HiMAP) applied
- High reliability secured, provides various operation information such as protection, measurement and control
- Firm external box, size and compact, making it safe
- Maintains high quality through stringent quality control system and continuous research and development



##### Cast Resin Transformer

· up to 36 kV, 20 MVA



# Marine

## Electrical Marine Equipment

- Production of high quality marine devices satisfying the regulations and standards of key marine associations (LRS, ABS, DNV, GL, BV, NK etc.) and world's renowned institutes
- High quality safety secured through the latest equipment and stringent quality control system
- Realization of optimal high efficiency by converging SWGR, Generator, Motor, Telecom, Automation and others



Marine Switchgear

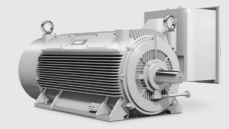

Marine Motor



Metal Clad Switchgear

- up to 38 kV
- IEC, ANSI



Low Voltage Switchgear & Motor Control Center

- H8PU : 660 V, 3,000 A, 80 kA
- H5600 : 660 V, 3,000 A, 100 kA
- HiMCC : 1,000 V, 5,000 A, 100 kA



Vacuum Circuit Breaker

- IEC, ANSI, UL
- up to 36/38 kV, 50 kA, 4,000 A



Air Circuit Breaker

- up to 150 kA, 6,300 A



Molded Case Circuit Breaker

- AC : up to 150 kA, 1,600 A
- DC : up to 100 kA, 800 A



Earth Leakage Circuit Breaker

- up to 85 kA, 800 A, 1,000 mA



Miniature Circuit Breaker

- up to 10 kA, 125 A



Contactor and Overload Relay

- up to 800 A



Vacuum Contactor

- up to 12 kV, 400 A



Surge Protection Device

- up to 200 kA
- AC, DC



Residual Current Circuit Breaker

- MCB : up to 10 kA, 125 A
- RCCB : up to 100 A, 500 mA



Installation Contactor

- up to 63 A



Manual Motor Starter

- up to 100 kA, 80 A



Fuse

- up to 1,250 A



Power System Monitoring and Protection Relay

- HGMAP Type
- HGCAM Type

- Wide range of breaking capacities and frames to meet all customer requirements
- Optimized design providing high performance
- Compact and reliable products type-tested by DEKRA and KERI



High Voltage AC Drive

- 220 ~ 440 V, ~ 132 kW

- Realizes powerful control performance through Sensor-less Vector Control and Auto Tuning
- High speed response due to Digital Signal Processor and High Speed My Com
- Compact design, enabling application in various environments
- Inverter manufactured using accumulated technology and know-how (outstanding technology of developing inverter for high-speed rail)



Digital Motor Protection Relay

- up to 60 A



Medium & High Voltage Induction Motor

- 150-30,000 HP
- 2-30 pole



Inverter Shield Motor

- 1-250 HP
- 2-6 pole



NEMA Premium Efficiency Motor

- 1-500 HP
- 2-6 pole



Explosion-Proof (Class 1 Div.1) Motor

- 1-500 HP
- 2-6 pole
- Hazardous Locations



# HG

## Molded Case Circuit Breakers & Earth Leakage Circuit Breakers

<b>Characteristics</b>	10
<b>Model Selection Table</b>	28
<b>Accessories</b>	
HGM General Type	72
HGP High Breaking Type	74
Internal Accessories	76
External Accessories	84
<b>Technical Data</b>	
Technical Data (HGM/HGE)	110
Technical Data (HGP)	124
Operation Characteristic Curve	149
<b>Dimensions</b>	166
<b>Order Code</b>	236
<b>Handling and Maintenance Inspection</b>	250
<b>Acquired Standards</b>	256

MCCB

## HG Series

# Molded Case Circuit Breakers & Earth Leakage Circuit Breakers

Maximized selectivity and safety with wide product range and reinforced breaking performance!





## Rated Short-Circuit Current by AF, (Ics = 100 % Icu at 440/460 V)

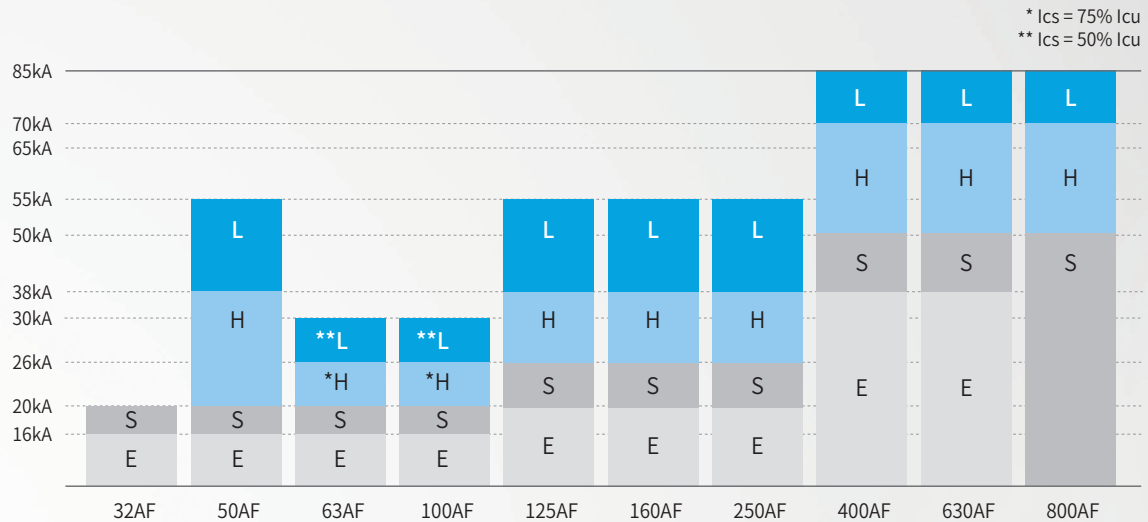

### Wide Product Range

HGM/HGE 32 AF ~ 800 AF

### High Breaking Capacity

16 kA ~ 85 kA (at 460 V), Ics = 100 % Icu

### Rated Insulation Voltage of 1,000 V

### Reinforcement of Protective Coordination

It enables selective breaking.

### Adjustable Rated Current (Molded Case Circuit Breaker)

32 ~ 250 AF : 0.8 - 0.9 - 1 Times the Rated Current  
400 ~ 800 AF : 0.63 - 0.8 - 1 Times the Rated Current

### Adjustable Residual Current (Earth Leakage Circuit Breaker)

100 - 300 - 500 - 1,000 (mA)

### Adjustable Residual Current's Non-Operation Hour (Earth Leakage Circuit Breaker)

0 - 200 - 500 - 1,000 (ms)



Molded Case Circuit Breakers



Earth Leakage Circuit Breakers

## Characteristics

### Enhanced Performance and Various Selectivity

Various Range of Products : 10 Frames, 32 ~ 800 AF

Compatible MCCB, ELCB Dimensions and Common Use of Accessories

Standardization of Product Depth per Frame : 32 ~ 250 AF (68 mm), 400 ~ 800 AF (110 mm)



32, 50, 63, 100 AF

50, 125 AF

160, 250 AF

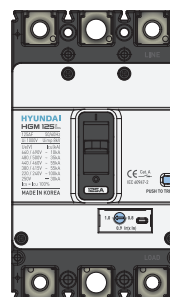

MCCB

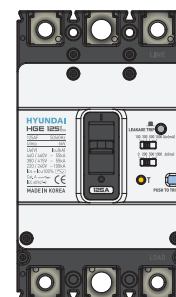

ELCB



400 AF



630, 800 AF

# Characteristics

## HGM Molded Case Circuit Breaker

### Maximized Insulation Performance

The safety of the product has been maximized through enhanced insulation voltage

- Rated Insulation Voltage,  $U_i$  : 1,000 V
- Rated Impulse Withstand Voltage,  $U_{imp}$  : 8 kV

### High Breaking Capacity

Maximum breaking capacity was realized with high breaking capacity in Korea.

- 16 ~ 30 kA at 460 V (32 ~ 100 AF)
- 20 ~ 55 kA at 460 V (125 ~ 250 AF)
- 38 ~ 85 kA at 460 V (400 ~ 800 AF)

### Cable Insulation Performance Suitability

In case there is a presence of abnormal condition such as welding of the main contact after tripping of the circuit breaker by realizing the cable insulation performance in accordance with IEC 60947-2, the handle does not move from ON to OFF position. This makes it safe by preventing the operation of circuit breaker caused by the operator's negligence.

### Adjustable Rated Current in all Frames

The adjustable rated current of up to 800 AF provides optimal protection for load variations in customer's equipment.

- Long Time ( $\leq 250$  AF) :  
3-step adjusting, 80 % - 90 % - 100 % of rated current
- Long Time (400 AF, 800 AF) :  
3-step adjusting, 63 % - 80 % - 100 % of rated current

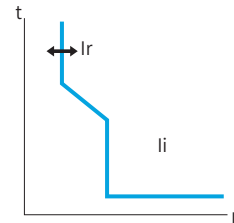

Characteristics Curve (I - t Curve)

### Sealing Structure (Option) Applied

Dial sealing structure is applied to prevent arbitrary change of the current set value using a protection cover (Prevent operation of thermal magnetic adjustment knob) (Option).

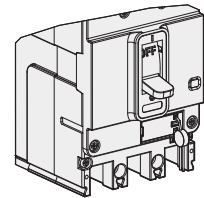

**HYUNDAI**  
**HGM 125H**  
125AF 50/60Hz  
 $U_i$  1000V  $U_{imp}$  8kV

CE Cat. A  
IEC 60947-2  
PUSH TO TRIP

$U_e$ (V)	$I_{cu}$ (kA)
660 / 690V	~ 8kA
480 / 500V	~ 26kA
440 / 460V	~ 38kA
415V	~ 38kA
380V	~ 42kA
220 / 240V	~ 85kA
250V	≡ 20kA
$I_{cs} = I_{cu} 100\%$	

1.0 ← 0.8  
**0.9  $I_r(x I_n)$**



### Service Breaking Capacity ( $I_{cs} = 100\% \times I_{cu}$ )

100 % service breaking capacity has been realized by significantly improving the breaking capacity by restricting accidental current using an internal current limiting device in case of short-circuit accidents.

- 32 ~ 800 AF
  - 16 ~ 55 kA @ 460 Vac (Below 250 AF)
  - 38 ~ 85 kA @ 460 Vac (400 ~ 800 AF)
- (HGM60, 100 H Type  $I_{cs} = 75\% I_{cu}$ , HGM60, 100 L Type  $I_{cs} = 50\% I_{cu}$ )

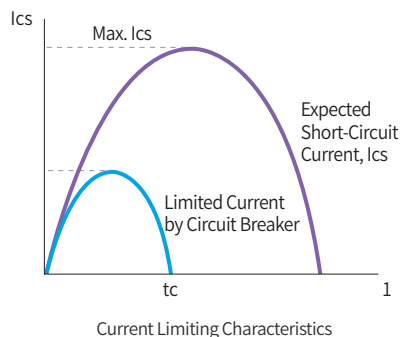

### Various Low Voltage System Protections

HGM Type MCCB realizes current limiting characteristics and outstanding breaking performance and enables various low voltage system protections such as discrimination and cascading.

#### Discrimination

It is a protection method in which when an accident occurs during load, the downstream circuit breaker that is directly related to the accident circuit operates first so that the other sound branch circuit breaker and the upstream main circuit breaker can feed continuously. It is a low voltage system protection method that can minimize the fault point by selectively preventing faults.

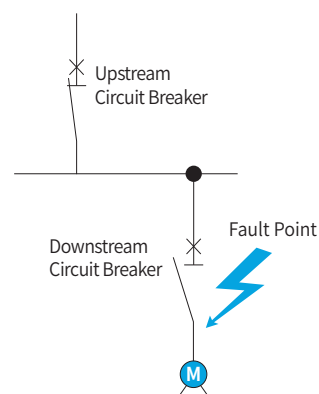

#### Cascading

In case an accident occurs during load, the upstream main circuit breaker operates earlier than the downstream circuit breaker of the accident circuit for back-up protection. It is an economic protection method. Thus, a circuit breaker with lower breaking capacity than the estimated short-circuit current can be applied.

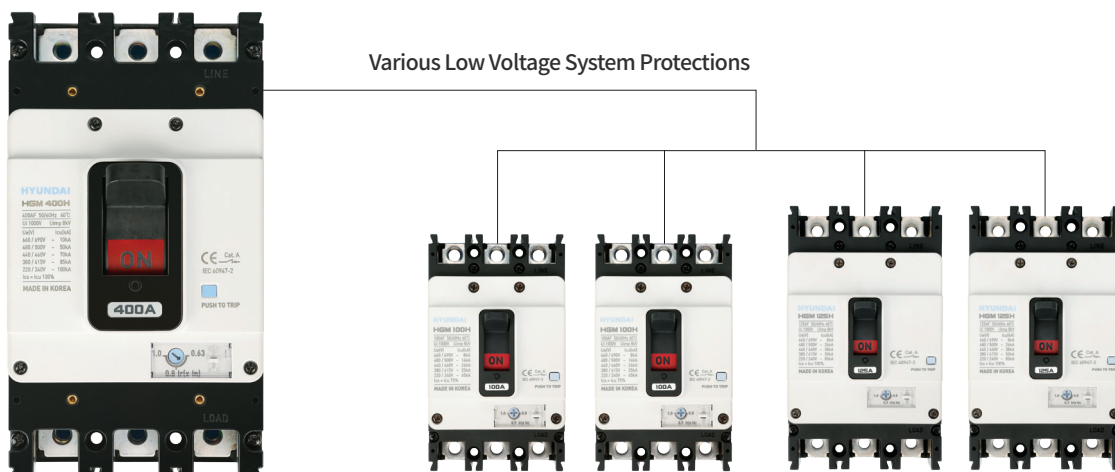

# Characteristics

## HGE Earth Leakage Circuit Breaker

### Secures Equivalent Breaking Performance with MCCB, Maintains Compatibility with Dimensions and Accessories

- Service Breaking Current,  $I_{cs} = 100\% I_{cu}$
- Rated Impulse Withstand Voltage,  $U_{imp} : 6\text{ kV}$

### Characteristics of Earth Leakage Protection

- Prevention function of damage caused by reverse connection : A circuit capable of preventing damage in PCB and Trip Coil has been applied to prevent damage despite usage during reserve connection caused by the misuse of user.
- The device is safe as it is equipped with a function that prevents unnecessary malfunction of earth leakage circuit breaker caused by temporary drop of voltage and noise signal.
- With the 3-phase power supply method, it safely breaks even during abnormal system voltage caused by open phase.
- By deploying filter circuit in IC, it safely protects the inverter load from grounding.

### Adjustable Residual Current / Operating Time

Item	Adjustable Residual Current				Cut-Off Time				
	30 mA	100 mA	300 mA	500 mA	1,000 mA	0 ms	200 ms	500 ms	1,000 ms
Previous (U-ELCB)	Fixed	Adjustable (3 Steps)			-	Fixed	-	-	-
New Product (HG-ELCB)	Fixed	Adjustable (4 Steps)				Adjustable (4 Steps)			

- With adjustable leakage current sensitivity (4 stages), prompt action can be taken without replacing the product depending on the load status.
- Selective protection coordination between upstream circuit breaker and downstream circuit breaker is possible through adjustable residual current and operating time, protecting the circuit safely

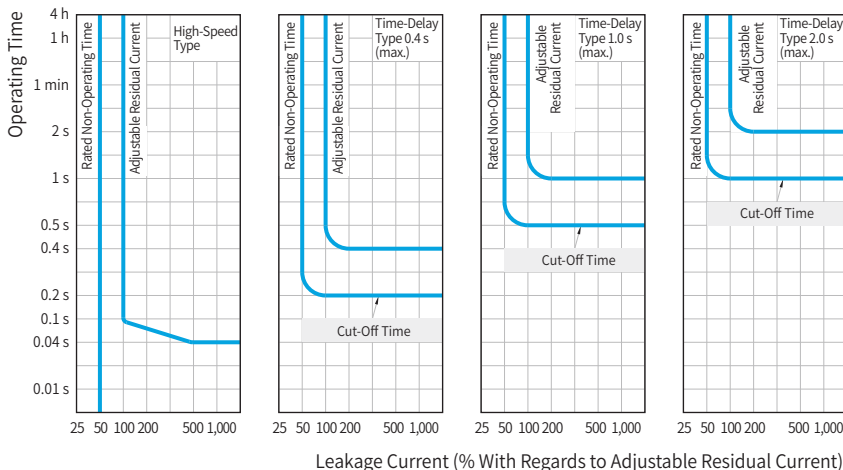
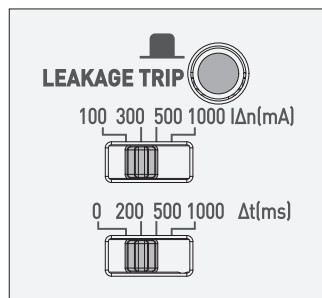

## Applicable standards and certifications

### Applicable Standards

#### Korean Standards

##### KS C 8321 Molded Case Circuit Breaker for Industrial Uses

(Molded Case Circuit Breaker for Industrial Uses)

##### KS C 4613 Circuit Breaker Incorporating Residual Current Protection for Industrial Uses (CBR)

(Circuit Breaker Incorporating Residual Current Protection for Industrial Uses (CBR))

#### International Standards

##### IEC 60947-1

Low Voltage Switchgear and Controlgear, Part 1 (General Rules)

##### IEC 60947-2

Low Voltage Switchgear and Controlgear, Part 2 (Circuit Breakers)



### Approvals and Certifications

HG-Series MCCB has acquired the testing/certification from certified testing institutes registered in STL in accordance with the IEC standard and domestic safety certifications (K 60747-2) and can be installed and applied depending on the usage environment and condition permitted in the standard.

- CB Certification (Certifying Institute, DEKRA)
- Safety Certification
- KS Certification
- Marine Approvals (8 Classifications)

#### Vibration/Shock-Proof Test Certification Acquired

Our product has qualified the vibration/shock-proof test in accordance with the IEC 60068-2-6 which is a requirement of IACS, an international vessel inspection institute.

- 5 ~ 13.2 Hz : Displacement (1 mm)
- 13.2 ~ 100 Hz : Acceleration (0.7 g)



Our services

Testing, Inspections, Certification DEKRA provides certification of management systems as well as technical support, testing and certification of a wide range of products throughout the life cycle.

## HG Series

# Molded Case Circuit Breakers (HGP Type)

Realizes optimal protection performance regardless of changes in load situation with rated adjustment design!





## Rated Short-Circuit Current by AF (Ics = 100 % Icu at 440/460 V)

150 kA	50DX	125DX	160DX	100X	160X	250X	400X	630X	800X
85 kA	50DH	125DH	160DH	100H	160H	250H	400H	630H	800H
70 kA									
65 kA	50DS	125DS	160DS	100S	160S	250S	400S	630S	800S
36 kA*	50DF	125DF	160DF	100F	160F	250F	400F	630F	800F
	50D AF	125D AF	160D AF	100 AF	160 AF	250 AF	400 AF	630 AF	800 AF

\* F type is for overseas sales.

## Wide Product Range

HGP 50 AF ~ 800 AF

## Realizes Maximum Breaking Capacity in Korea

150 kA (at 460 V)

## Reinforcement of Protective Coordination

It enables selective breaking.

## Acquisition of Various Certifications

DEKRA, marine and KS certifications have been acquired.

## Adjustable Operating Characteristics

### Rated Current

3-Steps, 0.8 - 1 Times the Rated Current  
(Thermal Magnetic Type)

9-Steps, 0.4 - 1 Times the Rated Current  
(Electronic Type)

### Instantaneous Current

6-Steps, 5 - 6 - 7 - 8 - 9 - 10 Times the Rated Current  
(Thermal Magnetic Type)

9-Steps, 1.5 - 10 Times the Rated Current  
(Electronic Type, Short Time Current)



Thermal Magnetic Type

Electronic Type

## Characteristics (HGP)

### Outstanding Protection Coordination and Maximized Breaking Capacity

Simplified Dimension with 4 Types from 50 ~ 800 AF

Adjustable Rated Currents in all Models

Owens the Outstanding Breaking Capacity in all Frames : 150 kA at 460 V

Various Breaking Coordination such as Selective Breaking and Others

Guaranteed Breaking Capacity in Reverse Connection



Trip Device : Thermal Magnetic Type

Trip Device : Thermal Magnetic Type, Electronic Type

50D, 125D, 160D AF

100, 160, 250 AF



Thermal Magnetic Type



Electronic Type



Trip Device : Thermal Magnetic Type, Electronic Type



Trip Device : Thermal Magnetic Type, Electronic Type

400, 630 AF

800 AF

# Characteristics (HGP)

## HGP MCCB Trip Device

- The device to monitor the system and send a breaking signal to protect load and a cable
- The external dimensions and accessories are for common use regardless of the type of a trip device.
- A trip unit is replaceable, which depends on load types and protection characteristics.  
(Common use for the circuit breaker body)
- It has various ratings and adjustable functions.

Thermal Magnetic Type

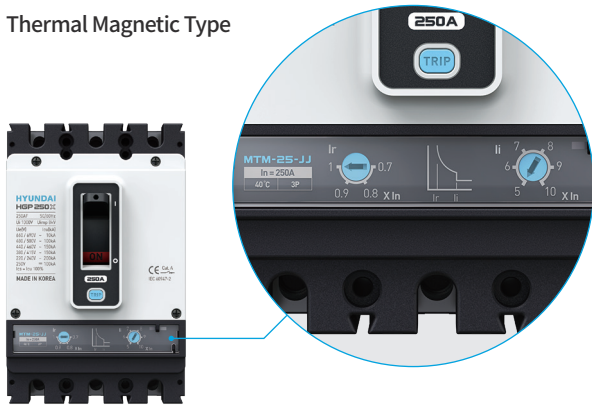

Electronic Type



Type	Rated Current (A)			
	2.5 ~ 12.5	16 ~ 80	100	125 ~ 800
Thermal Magnetic (Thermal Fixed / Instantaneous Fixed)		●	●	●
Thermal Magnetic (Thermal Adjustable / Instantaneous Fixed)		●	●	●
Thermal Magnetic (Thermal Adjustable / Instantaneous Adjustable)			●	●
Electronic (E, A, N, D Type)			●	●
For Motor Protection, Switch-Disconnecter	●	●	●	●

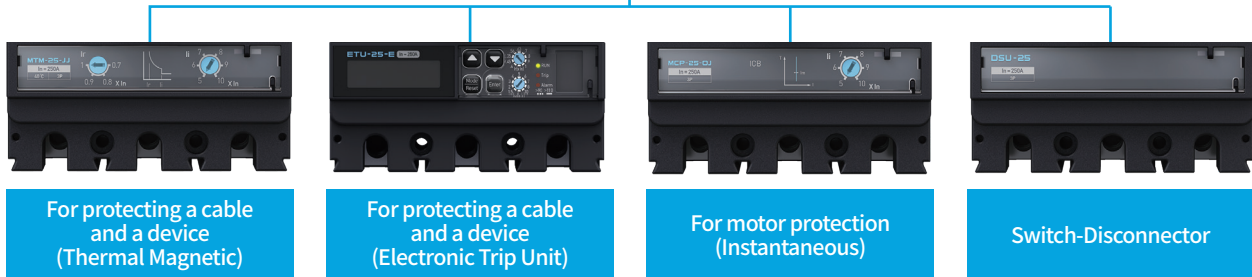

**For protecting a cable and a device (Thermal Magnetic)**

- MTM-25-FF : Thermal Fixed / Instantaneous Fixed
- MTM-25-JF : Thermal Adjustable / Instantaneous Fixed
- MTM-25-JJ : Thermal Adjustable / Instantaneous Adjustable

**For protecting a cable and a device (Electronic Trip Unit)**

- ETU-25-N : Normal Type
- ETU-25-D : Display Type
- ETU-25-A : Ammeter Type
- ETU-25-E : Energy-meter Type

**For motor protection (Instantaneous Adjustable)**

- MCP-25-OJ : Instantaneous Adjustable

**Switch-Disconnecter**

- DSU-25 : No protection

## HGP Type ETU (Electrical Trip Unit)

- Equipped with intelligent electronic function for a new era
- Maximizes a system energy efficiency the function of monitoring commutation and power

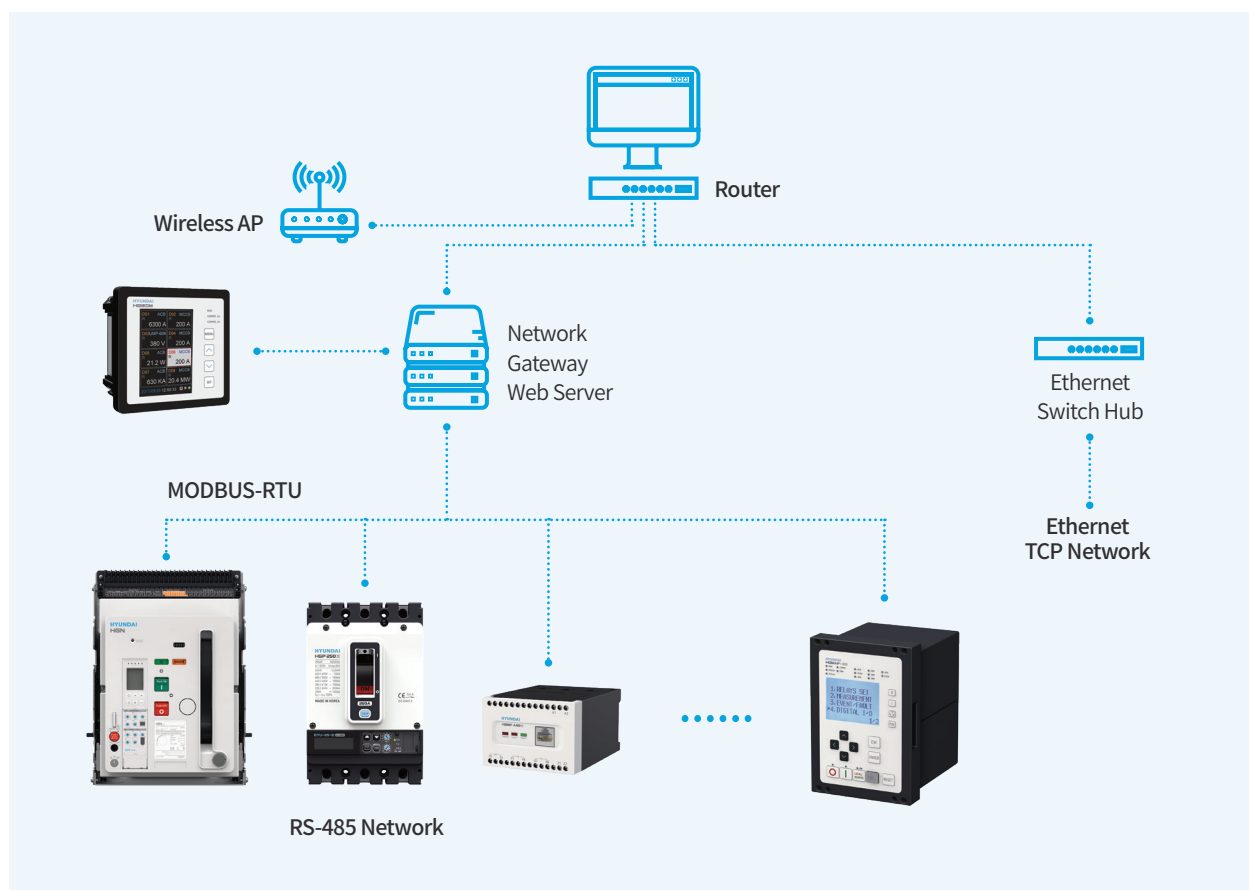
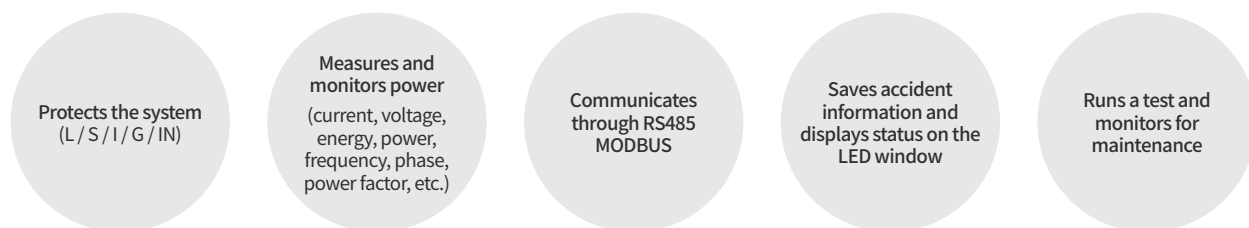

It checks current status on the front display and product status on the LED window. (Pre trip alarm)



It monitors the system with a maintenance tool.



It applies a transparent protection cover. (prevent pollution and operation)

# Characteristics (HGP)

## HGP Molded Case Circuit Breaker

### Maximized Insulation Performance

The safety of the product has been maximized through improved insulation voltage

- Rated Insulation Voltage,  $U_i$  : 1,000 V
- Rated Impulse Withstand Voltage,  $U_{imp}$  : 8 kV

### High Breaking Capacity

Maximum breaking capacity was realized with regards to all frames with high breaking capacity in Korea.

- 150 kA at 460 V (Same performance secured in all frames)

### Cable Insulation Performance Suitability

In case there is presence of abnormal condition such as welding of the main contact after tripping the circuit breaker by realizing the cable insulation performance in accordance with IEC 60947-2, the handle does not move from ON to OFF position, making it safe by preventing the operation of circuit breaker caused by the operator's negligence.

### Adjustable Rated Current in all Frames

The adjustable rated current of up to 800 AF provides optimal protection for load variations in customer's equipment.

- Rated Current
  - Thermal Magnetic Type : 0.8 - 1 times the rated current (3 Step)
  - Electronic Type : 0.4 - 1 times the rated current (9 Step)
- Instantaneous Current
  - Thermal Magnetic Type : 5 - 6 - 7 - 8 - 9 - 10 times the rated current (6 Step)
  - Electronic Type : 1.5 - 10 times the rated current (9 Step, Short Time Adjusting)

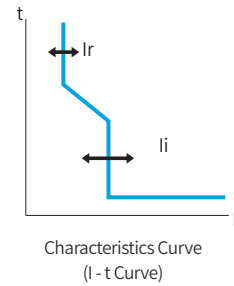

### Sealing Structure (Option) Applied

Dial sealing structure was applied to prevent arbitrary change of the current set value using a protection cover (Prevent operation of thermal magnetic adjustment knob) (Option).

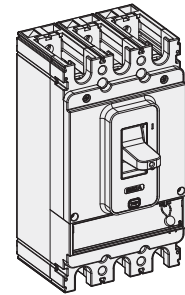

**HYUNDAI**  
**HGP 630S**

630AF	50/60Hz
$U_i$ 1000V	$U_{imp}$ 8kV

**CE** Cat. A  
IEC 60947-2

$U_e$ (V)	$I_{cu}$ (kA)
660 / 690V	~ 10kA
480 / 500V	~ 50kA
440 / 460V	~ 70kA
380 / 415V	~ 85kA
220 / 240V	~ 100kA
240V	65kA

$I_{cs} = I_{cu} 100\%$



### Service Breaking Capacity ( $I_{cs} = 100\% \times I_{cu}$ )

100% service breaking capacity has been realized by significantly enhancing the breaking capacity by restricting accidental current using an internal current limiting device in case of short-circuit accidents.

- 50 ~ 800 AF
- 36 ~ 150 kA @ 460 Vac

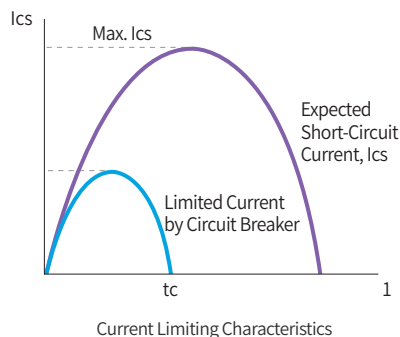

### Guaranteed Breaking Capacity in Reverse Connection

The same breaking performance is guaranteed even if the device is used by mixing LINE (Line side)/LOAD (Load side).

- Realizes integrated barrier circuit breaker that reinforces phase to phase insulation
- Realizes fast breaking operating characteristics by applying instantaneous mechanism part

### Various Low Voltage System Protections

HGP Type MCCB realizes current limiting characteristics and outstanding breaking performance and enables various low voltage system protections such as discrimination and cascading.

#### Discrimination

It is a protection method in which when an accident occurs during load, the downstream circuit breaker that is directly related to the accident circuit operates first so that the other sound branch circuit breaker and the upstream main circuit breaker can feed continuously. It is a low voltage system protection method that can minimize the fault point by selectively preventing faults.

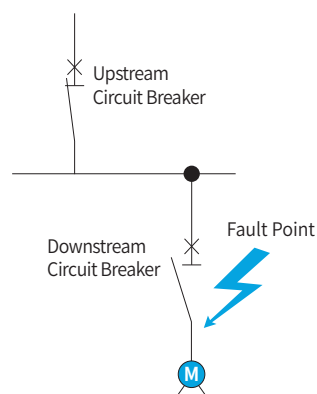

#### Cascading

In case an accident occurs during load, the upstream main circuit breaker operates earlier than the downstream circuit breaker of the accident circuit for back-up protection. It is an economic protection method that enables circuit breaker with lower breaking capacity than the estimated short-circuit current to be applied.



## External Structure and Indications

### Molded Case Circuit Breaker (MCCB)

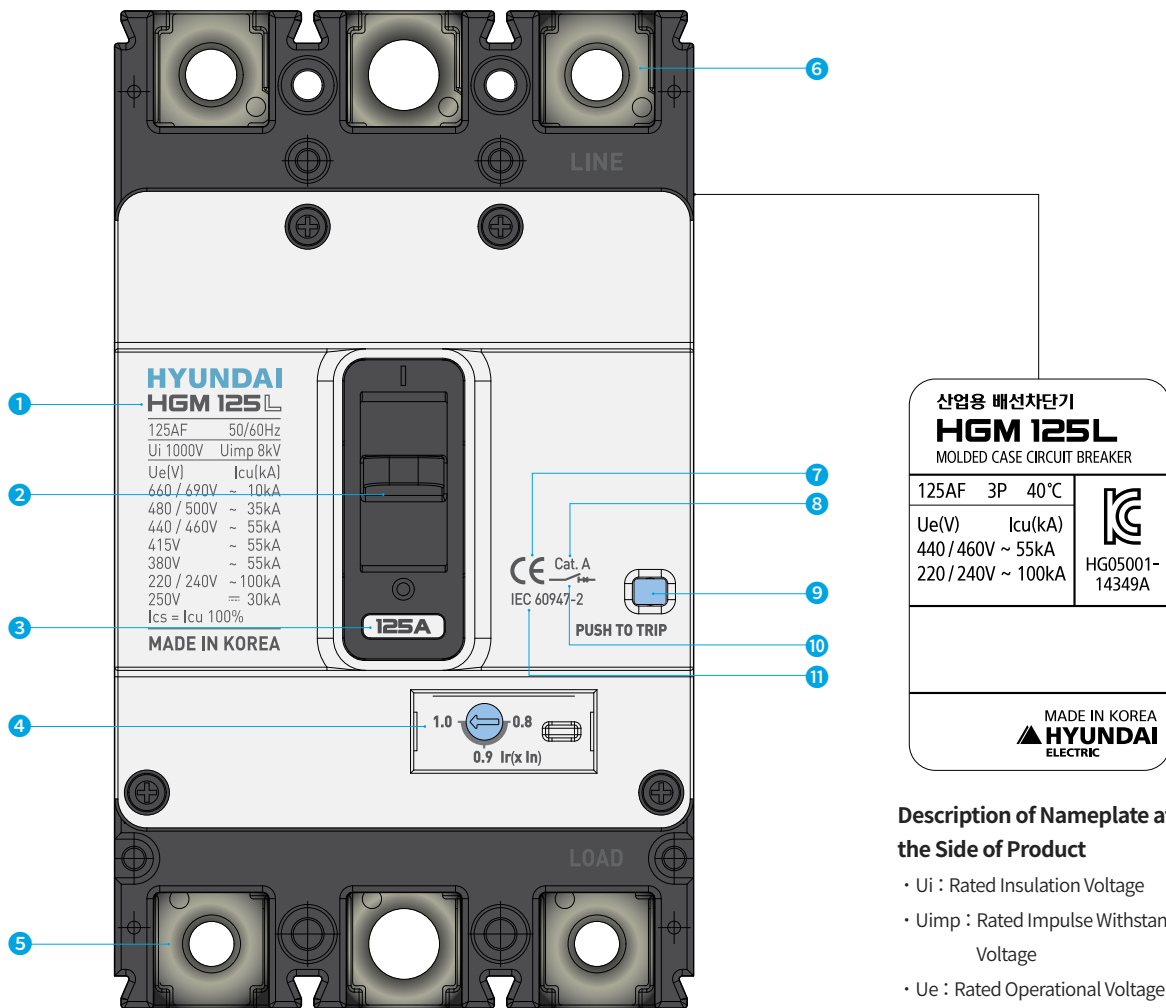

#### Description of Nameplate at the Side of Product

- Ui : Rated Insulation Voltage
- Uimp : Rated Impulse Withstand Voltage
- Ue : Rated Operational Voltage
- Icu : Rated Ultimate Short-Circuit Breaking Capacity (o-co)
- Ics : Rated Service Short-Circuit Breaking Capacity (o-co-co)



#### Molded Case Circuit Breaker (MCCB)

- |                                 |                        |  |
|---------------------------------|------------------------|--|
| ① Manufacturer and Product Name | ⑤ Load Side Terminal   | ⑨ Trip Button                              |
| ② Operating Handle              | ⑥ Line Side Terminal   | ⑩ Cable Insulation Performance Suitability |
| ③ Rated Current Nameplate       | ⑦ CE Marking           | ⑪ Reference Standard                       |
| ④ Rated Current Adjusting Dial  | ⑧ Utilization Category |  |

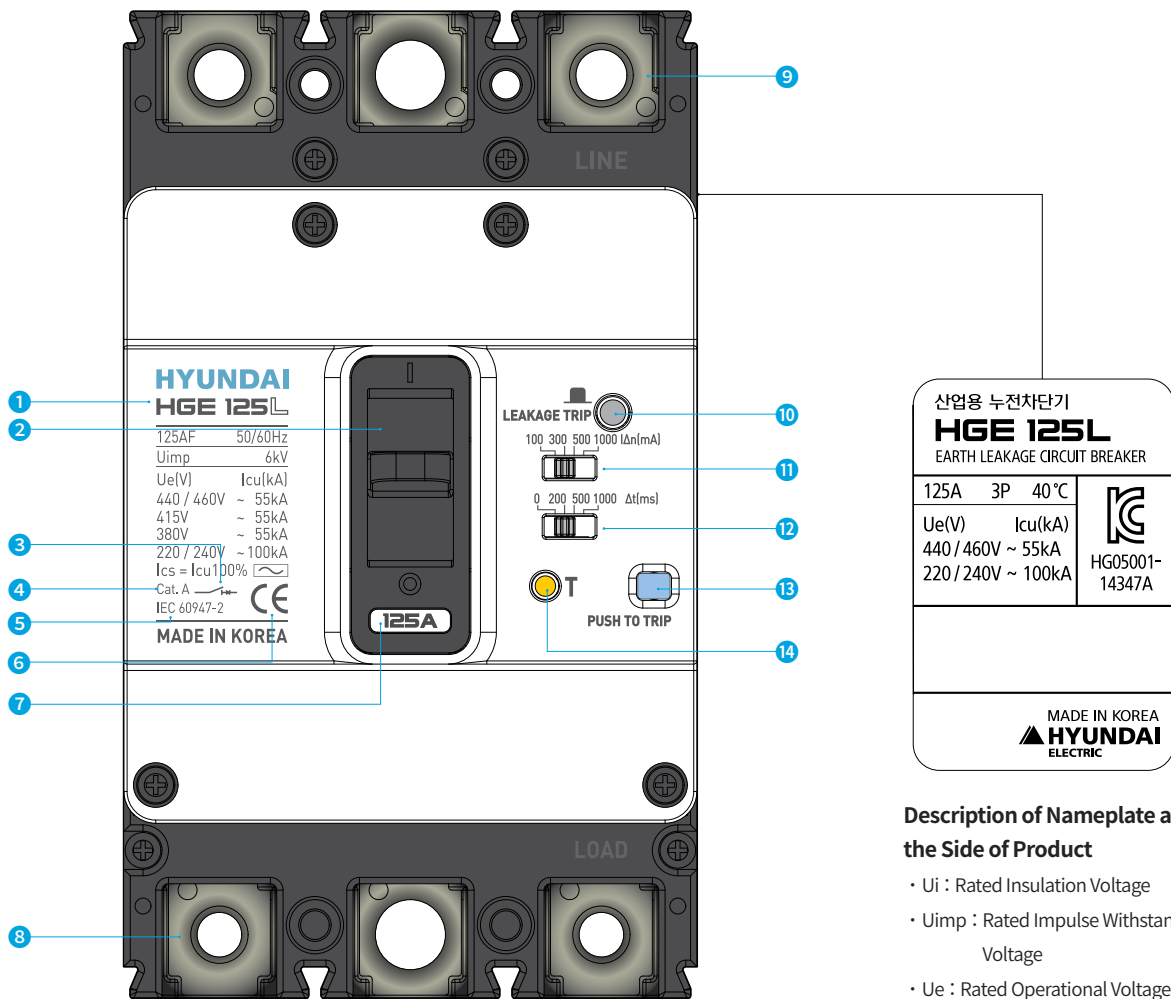

## Earth Leakage Circuit Breakers (ELCB)



산업용 누전차단기			
<b>HGE 125L</b> EARTH LEAKAGE CIRCUIT BREAKER			
125A	3P	40°C	HG05001-14347A
Ue(V)	Icu(kA)		
440 / 460V ~ 55kA	220 / 240V ~ 100kA		
MADE IN KOREA 			

### Description of Nameplate at the Side of Product

- Ui : Rated Insulation Voltage
- Uimp : Rated Impulse Withstand Voltage
- Ue : Rated Operational Voltage
- Icu : Rated Ultimate Short-Circuit Breaking Capacity (o-co)
- Ics : Rated Service Short-Circuit Breaking Capacity (o-co-co)

### Earth Leakage Circuit Breakers (ELCB)

1 Manufacturer and Product Name 2 Operating Handle 3 Cable Insulation Performance Suitability	4 Utilization Category 5 Reference Standard 6 CE Marking 7 Rated Current Nameplate 8 Load Side Terminal	9 Line Side Terminal 10 Leakage Trip Indication Device 11 Adjustable Residual Current Setting Switch	12 Rated Non-Operating Time Setting Switch 13 Trip Button 14 Leakage Test Button
---	---	--	--

## External Structure and Indications

### Molded Case Circuit Breaker (HGP Type)

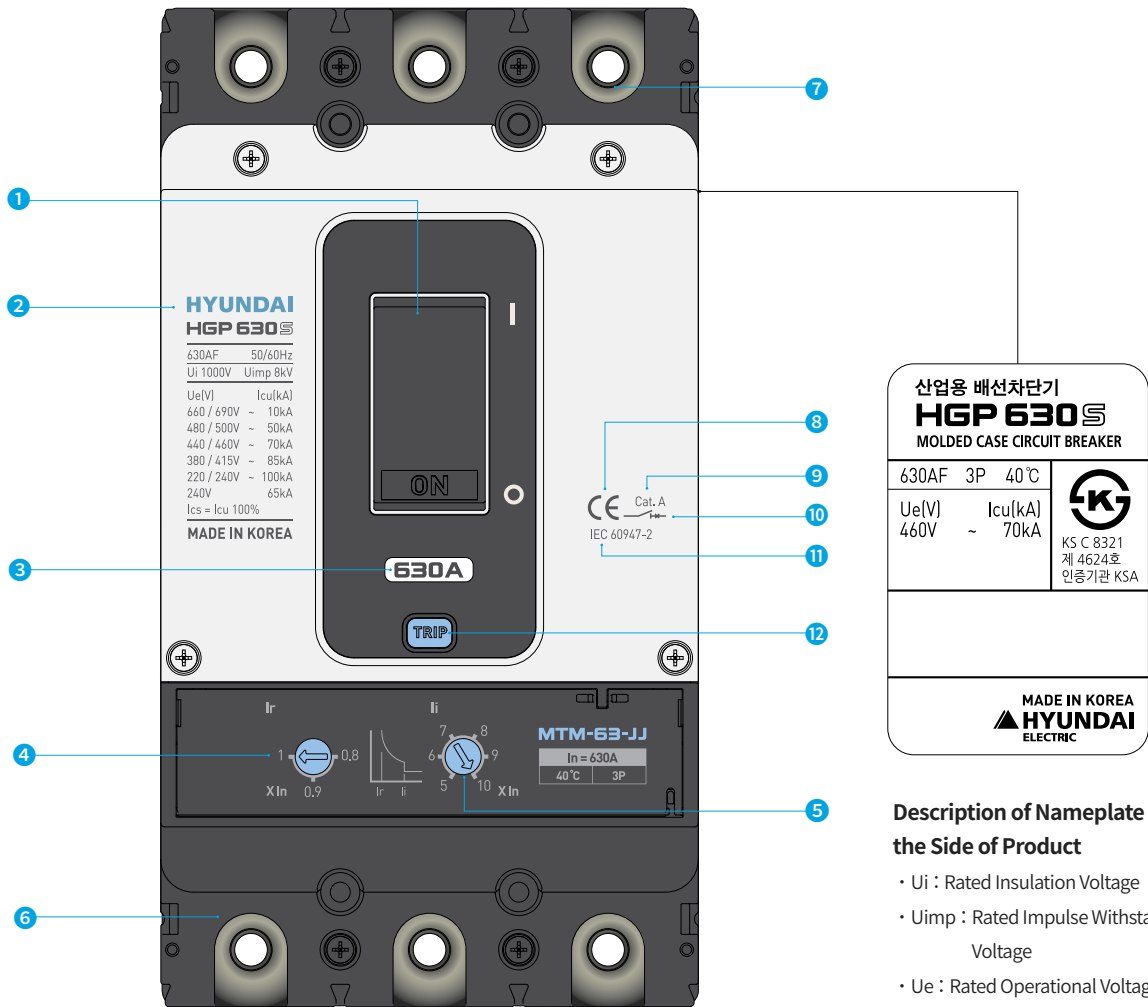

#### Description of Nameplate at the Side of Product

- Ui : Rated Insulation Voltage
- Uimp : Rated Impulse Withstand Voltage
- Ue : Rated Operational Voltage
- Icu : Rated Ultimate Short-Circuit Breaking Capacity (o-co)
- Ics : Rated Service Short-Circuit Breaking Capacity (o-co-co)

#### Molded Case Circuit Breaker (HGP Type)

- |   |  |   |
|---|--|---|
| 1 Operating Handle                      | 5 Instantaneous Operating Current Adjusting Dial | 9 Utilization Category                      |
| 2 Manufacturer and Product Name         | 6 Load Side Terminal                             | 10 Cable Insulation Performance Suitability |
| 3 Rated Current Nameplate               | 7 Line Side Terminal                             | 11 Reference Standard                       |
| 4 Long Operating Current Adjusting Dial | 8 CE Marking                                     | 12 Trip Button                              |

## Molded Case Circuit Breaker (HGP DC Type)

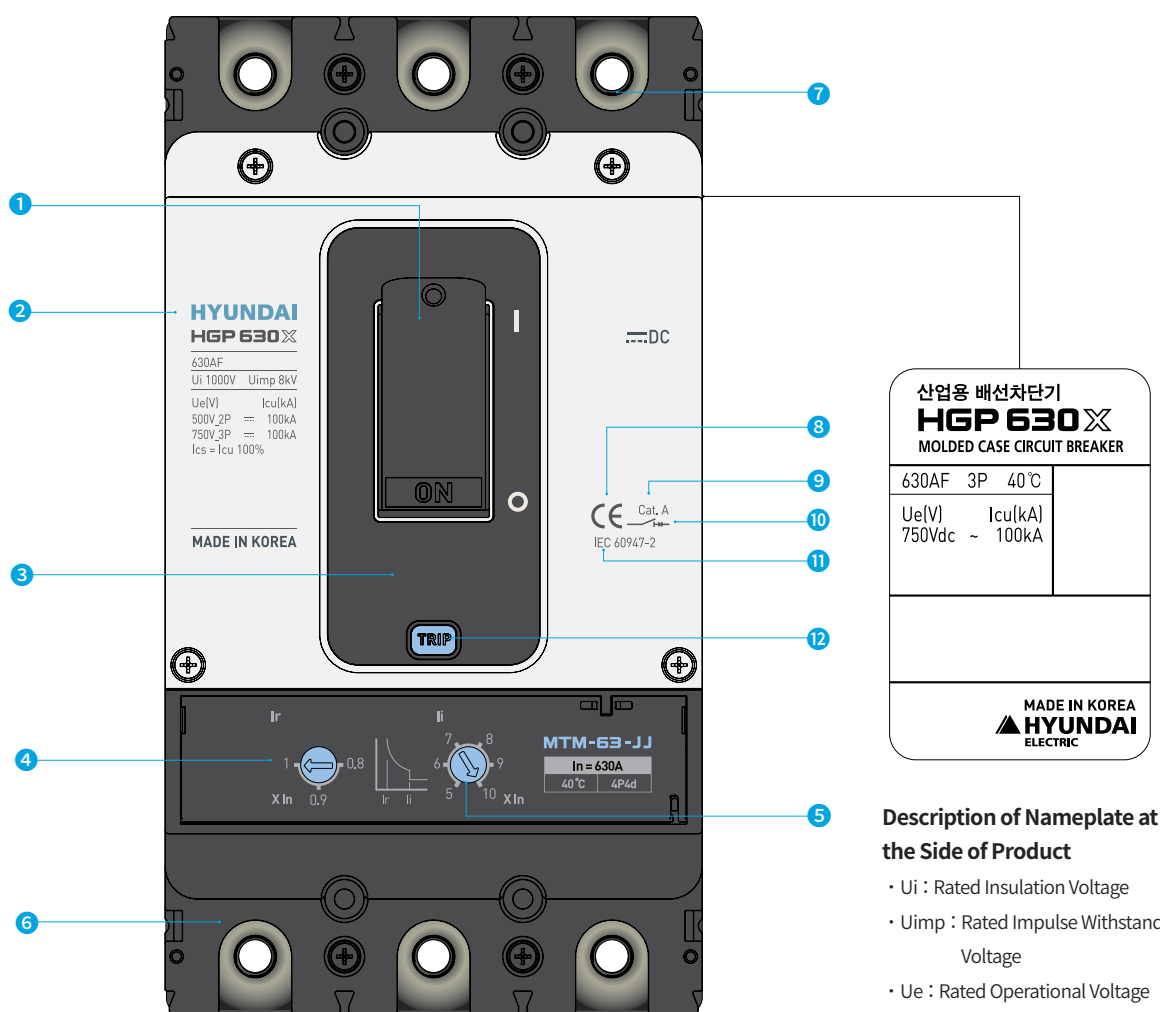

### Description of Nameplate at the Side of Product

- Ui : Rated Insulation Voltage
- Uimp : Rated Impulse Withstand Voltage
- Ue : Rated Operational Voltage
- Icu : Rated Ultimate Short-Circuit Breaking Capacity (o-co)
- Ics : Rated Service Short-Circuit Breaking Capacity (o-co-co)

### Molded Case Circuit Breaker (HGP Type)

- |   |  |   |
|---|--|---|
| 1 Operating Handle                      | 5 Instantaneous Operating Current Adjusting Dial | 9 Utilization Category                      |
| 2 Manufacturer and Product Name         | 6 Load Side Terminal                             | 10 Cable Insulation Performance Suitability |
| 3 Rated Current Nameplate               | 7 Line Side Terminal                             | 11 Reference Standard                       |
| 4 Long Operating Current Adjusting Dial | 8 CE Marking                                     | 12 Trip Button                              |

# Model Selection Table

## Molded Case Circuit Breaker (HGM Type) : 32 ~ 250 AF

### Common Ratings

Rated Insulation Voltage, Ui	1,000 V	Suitability for Isolation	Yes
Rated Operational Voltage, Ue	690 V	Utilization Category	A
Rated Impulse Withstand Voltage, Uimp	8 kV	Pollution Degree	3
Protection Function	Overload, Instantaneous, Short-Circuit Protection	Reference Standard	IEC 60947-2

Model Name	HGM30		HGM50				HGM60					
Frame (AF)	32		50				63					
Number of Poles (P)	2, 3, 4 <sup>1)</sup>		2, 3, 4 <sup>1)</sup>				2, 3, 4 <sup>1)</sup>					
Rated Current, at 40 °C (A)	16, 20, 25, 32		16, 20, 25, 32, 40, 50				16, 20, 25, 32, 40, 50, 63					
<b>Rated Ultimate Short-Circuit Breaking Capacity [Icu] (kA rms)</b>												
Short-Circuit Breaking Category Code	E	S	E	S	H	L	E	S	H	L		
AC 660/690 V	2.5	5	2.5	5	8	10	2.5	5	7.5	8		
AC 480/500 V	7.5	10	7.5	10	26	35	7.5	10	14	26		
<b>AC 415/440/460 V</b>	<b>16</b>	<b>20</b>	<b>16</b>	<b>20</b>	<b>38</b>	<b>55</b>	<b>16</b>	<b>20</b>	<b>26</b>	<b>30</b>		
AC 380 V	18	22	18	22	42	55	18	22	30	31		
AC 220/240 V	35	50	35	50	85	100	35	50	50	50		
DC 250 V (2P)	5	10	5	10	20	30	5	10	15	15		
Service Breaking Capacity [Ics = % Icu]	100	100	100	100	100	100	100	100	75	50		
<b>Rated Short-Circuit Making Capacity [Icm] (kA peak)</b>												
AC 660/690 V	4	8	4	8	14	17	4	8	13	14		
AC 480/500 V	13	17	13	17	55	74	13	17	28	55		
<b>AC 415/440/460 V</b>	<b>32</b>	<b>40</b>	<b>32</b>	<b>40</b>	<b>80</b>	<b>121</b>	<b>32</b>	<b>40</b>	<b>55</b>	<b>63</b>		
AC 380 V	36	47	36	47	89	121	36	47	63	66		
AC 220/240 V	74	105	74	105	187	220	74	105	105	105		
DC 250 V (2P)	8	17	8	17	40	63	8	17	30	30		
<b>Endurance [times] (Durability)</b>												
Mechanical	30,000		30,000				30,000					
Electrical (at 460 V)	10,000		10,000				10,000					
<b>Trip Device</b>												
Thermal Magnetic	Long Time [LTD]	Fixed	(1.0) × In		(1.0) × In				(1.0) × In			
		Adjustable	(0.8 - 0.9 - 1.0) × In		(0.8 - 0.9 - 1.0) × In				(0.8 - 0.9 - 1.0) × In			
	Instantaneous [INST]		400 A		16 ~ 32 A : 400 A, 40 ~ 50 A : 10 × In				16 ~ 32 A : 400 A, 40 ~ 63 A : 10 × In			
<b>Accessory</b>												
Internal	Auxiliary Switch	AUX	●		●				●			
	Alarm Switch	ALT	●		●				●			
	Shunt Trip	SHT	●		●				●			
	Under-Voltage Trip	UVT	●		●				●			
Rotary Handle	Front Contact	TFG	●		●				●			
	Extension	TFH	●		●				●			
	Mechanical Open/Close Device	MOT	●		●				●			
External	Mechanical Interlock	MIF	●		●				●			
	Handle Locking Device	PLD	●		●				●			
	Plug-in	TDM (LINE/LOAD)		● (3P Only)		● (3P Only)		● (3P Only)		● (3P Only)		
		TDM (LINE Only)		● (3P Only)		● (3P Only)		● (3P Only)		● (3P Only)		
		TDF (LINE Only)		● (3P Only)		● (3P Only)		● (3P Only)		● (3P Only)		
		TDA (1 row)		● (3P Only)		● (3P Only)		● (3P Only)		● (3P Only)		
		TDA (2 rows)		● (2, 3P Only)		● (2, 3P Only)		● (3P Only)		● (2, 3P Only)		
	Cage Terminal Block	CTB	●		●				●			
	Terminal Cover	TCF	●		●				●			
	Insulation Barrier	TQQ	●		●				●			
Terminal Bus Bar	TBB	-		-				-				
<b>Installation and Dimensions</b>												
Connection/ Installation	Front Connection	Terminal Screw										
	Rear Connection	Horizontal/Vertical										
	Plug-in	Switchgear (Line & Load, Line Only), Switchboard										
	DIN Rail Installation	Possible if DIN Rail adaptor is used	-	Possible if DIN Rail adaptor is used								
Dimension (mm)	a (2/3/4P)	50/75/100	50/75/100	60/90/120	50/75/100							
	b	130	130	155	130							
	c	68	68	68	68							
Weight (kg)	2/3/4P	0.6/0.8/1.0	0.6/0.8/1.0	0.8/1.0/1.3	0.6/0.8/1.0							
Detailed Rating and Selection		232 Page		232 Page		232 Page		232 Page				
Characteristic Curve and Appearance		149 / 166 Page		149 / 166 Page		150 / 167 Page		149 / 166 Page				

※ 1) 4 Pole Arrangement : Basic specification of R-S-T-N (N-R-S-T is optional).

2) As for 2P products, only the neutral pole in the 3P product has been eliminated so the dimension is equivalent to the 3P product.

HGM100				HGM125				HGM160				HGM250			
100				125				160				250			
2, 3, 4 <sup>1)</sup>				2, 3, 4 <sup>1)</sup>				2 <sup>2)</sup> , 3, 4 <sup>1)</sup>				2 <sup>2)</sup> , 3, 4 <sup>1)</sup>			
16, 20, 25, 32, 40, 50, 63, 75, 80, 100				16, 20, 25, 32, 40, 50, 63, 75, 80, 100, 125				100, 125, 150, 160				100, 125, 150, 160, 175, 200, 225, 250			
E	S	H	L	E	S	H	L	E	S	H	L	E	S	H	L
2.5	5	7.5	8	5	7.5	8	10	7.5	8	8	10	7.5	8	8	10
7.5	10	14	26	10	14	26	35	14	20	26	35	14	20	26	35
16	20	26	30	20	26	38	55	20	26	38	55	20	26	38	55
18	22	30	31	22	30	42	55	22	30	42	55	22	30	42	55
35	50	50	50	50	65	85	100	50	65	85	100	50	65	85	100
5	10	15	15	10	15	20	30	10	15	20	30	10	15	20	30
100	100	75	50	100	100	100	100	100	100	100	100	100	100	100	100
4	8	13	14	8	13	14	17	8	13	14	17	8	13	14	17
13	17	28	55	17	28	55	74	17	28	55	74	17	28	55	74
32	40	55	63	40	55	80	121	40	55	80	121	40	55	80	121
36	47	63	66	47	63	89	121	47	63	89	121	47	63	89	121
74	105	105	105	105	143	187	220	105	143	187	220	105	143	187	220
8	17	30	30	17	30	40	63	17	30	40	63	17	30	40	63
30,000				30,000				25,000				25,000			
10,000				10,000				10,000				10,000			
(1.0)×In				(1.0)×In				(1.0)×In				(1.0)×In			
(0.8 - 0.9 - 1.0)×In				(0.8 - 0.9 - 1.0)×In				(0.8 - 0.9 - 1.0)×In				(0.8 - 0.9 - 1.0)×In			
16 ~ 32 A : 400 A, 40 ~ 100 A : 10×In				16 ~ 32 A : 400 A, 40 ~ 125 A : 10×In				10×In				10×In			
●				●				●				●			
●				●				●				●			
●				●				●				●			
●				●				●				●			
●				●				●				●			
●				●				●				●			
●				●				●				●			
●				●				●				●			
●				●				●				●			
● (3P Only)				● (3P Only)				● (3P Only)				● (3P Only)			
● (3P Only)				● (3P Only)				● (3P Only)				● (3P Only)			
● (3P Only)				● (3P Only)				-				-			
● (3P Only)				● (3P Only)				-				-			
● (2, 3P Only)				● (3P Only)				-				-			
●				●				●				●			
●				●				●				●			
●				●				●				●			
-				-				●				●			
Terminal Screw Horizontal/Vertical								Terminal Screw, Terminal Bus Bar Horizontal/Vertical							
Switchgear (Line & Load, Line Only), Switchboard								Switchgear (Line & Load, Line Only)							
Possible if DIN Rail adaptor is used								-							
50/75/100				60/90/120				105/105/140				105/105/140			
130				155				165				165			
68				68				68				68			
0.6/0.8/1.0				0.8/1.0/1.3				1.1/1.3/1.7				1.1/1.3/1.7			
232 Page				232 Page				232 Page				232 Page			
149 / 166 Page				150 / 167 Page				151 / 168 Page				151 / 168 Page			

# Model Selection Table

## Molded Case Circuit Breaker (HGM Type) : 400 ~ 800 AF

### Common Ratings

Rated Insulation Voltage, Ui	1,000 V	Suitability for Isolation	Yes
Rated Operational Voltage, Ue	690 V	Utilization Category	A
Rated Impulse Withstand Voltage, Uimp	8 kV	Pollution Degree	3
Protection Function	Overload, Instantaneous, Short-Circuit Protection	Reference Standard	IEC 60947-2

Model Name	HGM400				HGM630				HGM800						
Frame (AF)	400				630				800						
Number of Poles (P)	2 <sup>2)</sup> , 3, 4 <sup>1)</sup>				2 <sup>2)</sup> , 3, 4 <sup>1)</sup>				2 <sup>2)</sup> , 3, 4 <sup>1)</sup>						
Rated Current, at 40 °C (A)	250, 300, 350, 400				500, 630				700, 800						
<b>Rated Ultimate Short-Circuit Breaking Capacity [Icu] (kA rms)</b>															
Short-Circuit Breaking Category Code	E	S	H	L	E	S	H	L	S	H	L				
AC 660/690 V	5	8	10	14	5	8	10	14	8	10	14				
AC 480/500 V	18	35	50	65	25	45	50	65	45	50	65				
AC 440/460 V	38	50	70	85	38	50	70	85	50	70	85				
AC 380/415 V	45	65	85	100	45	65	85	100	65	85	100				
AC 220/240 V	50	75	100	125	50	75	100	125	75	100	125				
DC 250 V (2P)	20	25	40	40	20	25	40	40	25	40	40				
Service Breaking Capacity [Ics = % Icu]	100	100	100	100	100	100	100	100	100	100	100				
<b>Rated Short-Circuit Making Capacity [Icm] (kA peak)</b>															
AC 660/690 V	8	14	17	28	8	14	17	28	14	17	28				
AC 480/500 V	36	74	105	143	53	95	105	143	95	105	143				
AC 440/460 V	80	105	154	187	80	105	154	187	105	154	187				
AC 380/415 V	95	143	187	220	95	143	187	220	143	187	220				
AC 220/240 V	105	165	220	275	105	165	220	275	165	220	275				
DC 250 V (2P)	40	53	84	84	40	53	84	84	53	84	84				
<b>Endurance [times] (Durability)</b>															
Mechanical	4,000				2,500				2,500						
Electrical (at 460 V)	1,000				500				500						
<b>Trip Device</b>															
Thermal Magnetic	Long Time [LTD]	Fixed	(1.0) × In				(1.0) × In				(1.0) × In				
		Adjustable	(0.63 - 0.8 - 1.0) × In <sup>3)</sup>				(0.63 - 0.8 - 1.0) × In				(0.63 - 0.8 - 1.0) × In				
	Instantaneous [INST]		10 × In				10 × In				10 × In				
<b>Accessory</b>															
Internal	Auxiliary Switch	AUX	●				●				●				
	Alarm Switch	ALT	●				●				●				
	Shunt Trip	SHT	●				●				●				
	Under-Voltage Trip	UVT	●				●				●				
External	Rotary Handle	Front Contact	TFG	●				●				●			
		Extension	TFH	●				●				●			
	Mechanical Open/Close Device	MOT	●				●				●				
	Mechanical Interlock	MIF	●				●				●				
	Handle Locking Device	PLD	●				●				●				
	Plug-in	TDM (LINE/LOAD)		● (3P Only)				● (3P Only)				● (3P Only)			
		TDM (LINE Only)		● (3P Only)				● (3P Only)				● (3P Only)			
		TDF (LINE Only)		-				-				-			
		TDA (1 row)		-				-				-			
		TDA (2 rows)		-				-				-			
Cage Terminal Block	CTB	●				●				●					
Terminal Cover	TCF	●				●				●					
Insulation Barrier	TQQ	●				●				●					
Terminal Bus Bar	TBB	●				●				●					
<b>Installation and Dimensions</b>															
Connection/ Installation	Front Connection	Terminal Screw				Terminal Screw, Terminal Bus Bar									
	Rear Connection	Horizontal/Vertical Cable				Horizontal/Vertical Cable									
Dimension (mm)	Plug-in	Switchgear (Line & Load, Line Only)				Switchgear (Line & Load, Line Only)									
	a (2/3/4P)	140/140/184				210/210/280				210/210/280					
	b	257				280				280					
	c	110				110				110					
Weight (kg)	2/3/4P	4/4.5/5.4				8.7/9.5/12.5				8.7/9.5/12.5					
Detailed Rating and Selection		232 Page				232 Page				232 Page					
Characteristic Curve and Appearance		151 / 169 Page				152 / 170 Page				152 / 170 Page					

※ 1) 4 Pole Arrangement : Basic specification of R-S-T-N (N-R-S-T is optional).

2) As for 2P products, only the neutral pole in the 3P product has been eliminated so the dimension is equivalent to the 3P product.

3) As for adjustable type, applicable to above 300 A.



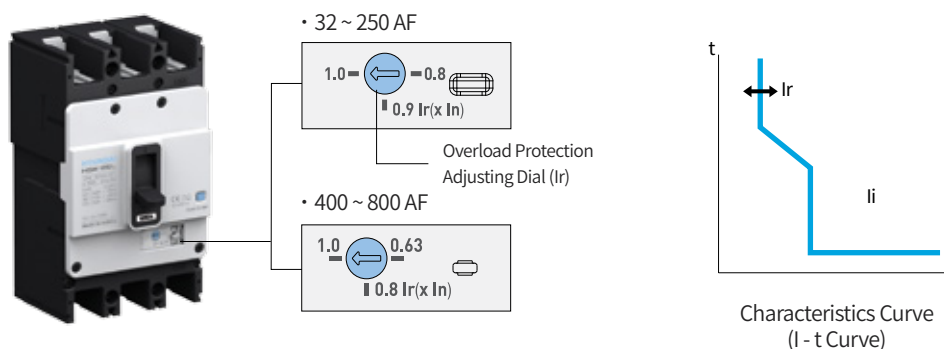

### Trip Unit Characteristics – Thermal Magnetic

Rated Current (A) In		16	20	25	32	40	50	63	75	80	100	125
MCCB	HGM30	●	●	●	●							
	HGM50	●	●	●	●	●	●					
	HGM60	●	●	●	●	●	●	●				
	HGM100	●	●	●	●	●	●	●	●	●	●	
	HGM125	●	●	●	●	●	●	●	●	●	●	●
Moment Characteristics Ir												
Setting Value (A)	Fixed	16	20	25	32	40	50	63	75	80	100	125
	0.8×In	12.8	16	20	25.6	32	40	50.4	60	64	80	100
	0.9×In	14.4	18	22.5	28.8	36	45	56.7	67.5	72	90	112.5
	1.0×In	16	20	25	32	40	50	63	75	80	100	125
Instantaneous Characteristics li												
Setting Value (A)	10×In (Min. 400 A)			400			500	630	750	800	1,000	1,250
	Max. Non-Tripping Current (A)			320			400	504	600	640	800	1,000
	Min. Tripping Current (A)			480			600	756	900	960	1,200	1,500
Neutral Pole Protection												
4P3D	Unprotected											
4P4D	-											

Rated Current (A) In		100	125	150	160	175	200	225	250	300	350	400	500	630	700	800
MCCB	HGM160	●	●	●	●											
	HGM250	●	●	●	●	●	●	●	●							
	HGM400								● <sup>1)</sup>	●	●	●				
	HGM630												●	●		
	HGM800														●	●
Moment Characteristics Ir																
Setting Value (A)	Fixed	100	125	150	160	175	200	225	250	300	350	400	500	630	700	800
	0.63×In									189	221	252	315	397	441	504
	0.8×In	80	100	120	128	140	160	180	200	240	280	320	400	504	560	640
	0.9×In	90	112.5	135	144	157.5	180	202.5	225							
	1.0×In	100	125	150	160	175	200	225	250	300	350	400	500	630	700	800
Instantaneous Characteristics li																
Setting Value (A)	10×In	1,000	1,250	1,500	1,600	1,750	2,000	2,250	2,500	3,000	3,500	4,000	5,000	6,300	7,000	8,000
	Max. Non-Tripping Current (A)	800	1,000	1,200	1,280	1,400	1,600	1,800	2,000	2,400	2,800	3,200	4,000	5,040	5,600	6,400
	Min. Tripping Current (A)	1,200	1,500	1,800	1,920	2,100	2,400	2,700	3,000	3,600	4,200	4,800	6,000	7,560	8,400	9,600
Neutral Pole Protection																
4P3D	Unprotected															
4P4D	-															

※ 1) HGM400 250 A is fixed type only.

# Model Selection Table

## Switch - Disconnecter (HGM NA Type) : 50 ~ 800 AF

Switch - disconnecter is a switch for disconnection without protective function and as the appearance is equivalent to the circuit breaker, all accessories of the circuit breaker can be shared.

### Common Ratings

Rated Insulation Voltage, Ui	1,000 V	Suitability for Isolation	Yes
Rated Operational Voltage, Ue	690 V	Utilization Category	AC 22 A/AC 23 A - DC 22 A/DC 23 A
Rated Impulse Withstand Voltage, Uimp	8 kV	Pollution Degree	3
		Reference Standard	IEC 60947-3

Model Name		HGM50NA	HGM100NA	HGM125NA	HGM160NA		
Frame	(AF)	50	100	125	160		
Number of Poles	(P)	3, 4 <sup>1)</sup>	3, 4 <sup>1)</sup>	3, 4 <sup>1)</sup>	3, 4 <sup>1)</sup>		
Conventional Free Air Thermal Current, Ith at 60 °C	(A)	50	100	125	160		
<b>Rated Operational Current [Ie]</b>							
AC 690 V (50/60 Hz)		50	100	125	160		
DC 125 V (1 Pole Connection)		50	100	125	160		
DC 250 V (2 Pole Connection)		50	100	125	160		
Rated Short Circuit Making Current [Icm] (kA Peak @ AC 460)		0.8	1.7	2.1	2.7		
Rated Short Time Withstand Current [Icw] (kA rms)		1	1	1	2		
<b>Endurance [times] (Durability)</b>							
Mechanical		30,000	30,000	30,000	25,000		
In @ 440 V		10,000	10,000	10,000	10,000		
<b>Accessory</b>							
Internal	Auxiliary Switch	AUX	●	●	●	●	
	Alarm Switch	ALT	●	●	●	●	
	Shunt Trip	SHT	●	●	●	●	
	Under-Voltage Trip	UVT	●	●	●	●	
External	Rotary Handle	Front Contact	TFG	●	●	●	●
		Extension	TFH	●	●	●	●
	Mechanical Open/Close Device		MOT	●	●	●	●
	Mechanical Interlock		MIF	●	●	●	●
	Handle Locking Device		PLD	●	●	●	●
	Plug-in	TDM (LINE/LOAD)		● (3P Only)	● (3P Only)	● (3P Only)	● (3P Only)
		TDM (LINE Only)		● (3P Only)	● (3P Only)	● (3P Only)	● (3P Only)
		TDF (LINE Only)		● (3P Only)	● (3P Only)	● (3P Only)	-
		TDA (1 row)		● (3P Only)	● (3P Only)	● (3P Only)	-
		TDA (2 rows)		● (3P Only)	● (3P Only)	● (3P Only)	-
Cage Terminal Block		CTB	●	●	●	●	
Terminal Cover		TCF	●	●	●	●	
Insulation Barrier		TQQ	●	●	●	●	
Terminal Bus Bar		TBB	-	-	-	●	
<b>Installation and Dimensions</b>							
Connection/ Installation	Front Connection	Terminal Screw			Terminal Screw, Terminal Bus Bar		
	Rear Connection	Horizontal/Vertical			Horizontal/Vertical		
	Plug-in	Switchgear (Line & Load, Line Only), Distribution Panel			Switchgear (Line & Load, Line Only)		
	DIN Rail Installation	Possible if DIN Rail adaptor is be used			-		
Dimension (mm)		a (3/4P)	75/100	75/100	90/120	105/140	
		b	130	130	155	165	
		c	68	68	68	68	
Weight (kg)	3/4P	0.8/1.0	0.8/1.0	1.0/1.3	1.3/1.7		
Detailed Rating and Selection		232 Page	232 Page	232 Page	232 Page		
Characteristic Curve and Appearance		166 Page	166 Page	167 Page	168 Page		

※ 1) 4 Pole Arrangement : Basic specification of R-S-T-N (N-R-S-T is optional.)



### Applicable Field of Switch – Disconnectors

- Bus bar connection and disconnection
- Disconnection of switchgear and control panel
- Switch for emergency power switchover (ATS)

HGM250NA	HGM400NA	HGM630NA	HGM800NA
250	400	630	800
3, 4 <sup>1)</sup>	3, 4 <sup>1)</sup>	3, 4 <sup>1)</sup>	3, 4 <sup>1)</sup>
250	400	630	800
250	400	630	800
250	400	630	800
4.2	6.8	10.7	13.6
2	4	6.3	8
25,000	4,000	2,500	2,500
10,000	1,000	500	500
●	●	●	●
●	●	●	●
●	●	●	●
●	●	●	●
●	●	●	●
●	●	●	●
●	●	●	●
●	●	●	●
●	●	●	●
● (3P Only)	● (3P Only)	● (3P Only)	● (3P Only)
● (3P Only)	● (3P Only)	● (3P Only)	● (3P Only)
-	-	-	-
-	-	-	-
-	-	-	-
●	●	●	●
●	●	●	●
●	●	●	●
●	●	●	●
Terminal Screw, Terminal Bus Bar	Terminal Screw	Terminal Screw, Terminal Bus Bar	Terminal Screw, Terminal Bus Bar
Horizontal/Vertical	Horizontal/Vertical Cable	Horizontal/Vertical Cable	Horizontal/Vertical Cable
Switchgear (Line & Load, Line Only)	Switchgear (Line & Load, Line Only)	Switchgear (Line & Load, Line Only)	Switchgear (Line & Load, Line Only)
-	-	-	-
105/140	140/184	210/280	210/280
165	257	280	280
68	110	110	110
1.3/1.7	4.5/5.4	9.5/12.5	9.5/12.5
232 Page	232 Page	232 Page	232 Page
168 Page	169 Page	170 Page	170 Page

# Model Selection Table

## Motor Protection Circuit Breakers (HGM MO Type) : 50 ~ 250 AF

### Common Ratings

Rated Insulation Voltage, Ui	1,000 V	Suitability for Isolation	Yes
Rated Operational Voltage, Ue	690 V	Utilization Category	A
Rated Impulse Withstand Voltage, Uimp	8 kV	Pollution Degree	3
Protection Function	Instantaneous, Short-Circuit Protection	Reference Standard	IEC 60947-2

Model Name		HGM50				HGM60				
Frame	(AF)	50				63				
Number of Poles	(P)	3				3				
Rated Current, at 40 °C	(A)	40, 50				40, 50, 63				
<b>Rated Ultimate Short-Circuit Breaking Capacity [Icu] (kA rms)</b>										
Short-Circuit Breaking Category Code		E	S	H	L	E	S	H	L	
AC 660/690 V		2.5	5	8	10	2.5	5	7.5	8	
AC 480/500 V		7.5	10	26	35	7.5	10	14	26	
AC 415/440/460 V		16	20	38	55	16	20	26	30	
AC 380 V		18	22	42	55	18	22	30	31	
AC 220/240 V		35	50	85	100	35	50	50	50	
DC 250 V (2P)		5	10	20	30	5	10	15	15	
Service Breaking Capacity [Ics = % Icu]		100	100	100	100	100	100	75	50	
<b>Rated Short-Circuit Making Capacity [Icm] (kA peak)</b>										
AC 660/690 V		4	8	14	17	4	8	13	14	
AC 480/500 V		13	17	55	74	13	17	28	55	
AC 415/440/460 V		32	40	80	121	32	40	55	63	
AC 380 V		36	47	89	121	36	47	63	66	
AC 220/240 V		74	105	187	220	74	105	105	105	
DC 250 V (2P)		8	17	40	63	8	17	30	30	
<b>Endurance [times] (Durability)</b>										
Mechanical		30,000				30,000				
Electrical (at 460V)		10,000				10,000				
<b>Trip Device</b>										
Magnetic		Instantaneous [INST]				10×In				
<b>Accessory</b>										
Internal	Auxiliary Switch	AUX	●				●			
	Alarm Switch	ALT	●				●			
	Shunt Trip	SHT	●				●			
	Under-Voltage Trip	UVT	●				●			
Rotary Handle	Front Contact	TFG	●				●			
		TFH	●				●			
	Mechanical Open/Close Device	MOT	●				●			
	Mechanical Interlock	MIF	●				●			
	Handle Locking Device	PLD	●				●			
External	Plug-in	TDM (LINE/LOAD)	● (3P Only)		● (3P Only)		● (3P Only)			
		TDM (LINE Only)	● (3P Only)		● (3P Only)		● (3P Only)			
		TDF (LINE Only)	● (3P Only)		● (3P Only)		● (3P Only)			
		TDA (1 row)	● (3P Only)		● (3P Only)		● (3P Only)			
		TDA (2 rows)	● (2, 3P Only)		● (3P Only)		● (2, 3P Only)			
	Cage Terminal Block	CTB	●				●			
Terminal Cover	TCF	●				●				
Insulation Barrier	TQQ	●				●				
Terminal Bus Bar	TBB	-				-				
<b>Installation and Dimensions</b>										
Connection/Installation	Front Connection	Terminal Screw								
	Rear Connection	Horizontal/Vertical								
	Plug-in	Switchgear (Line & Load, Line Only), Distribution Panel								
Dimension (mm)	DIN Rail Installation	Possible if DIN Rail adaptor is be used	-	Possible if DIN Rail adaptor is be used						
	a	75	90	75						
	b	130	155	130						
	c	68	68	68						
Weight (kg)	3P	0.8	1.0	0.8						
Detailed Rating and Selection		232 Page	232 Page	232 Page						
Characteristic Curve and Appearance		149 / 166 Page	150 / 167 Page	149 / 166 Page						



HGM100				HGM125				HGM160				HGM250			
100				125				160				250			
3				3				3				3			
40, 50, 63, 75, 80, 100				40, 50, 63, 75, 80, 100, 125				100, 125, 150, 160				100, 125, 150, 160, 175, 200, 225, 250			
E	S	H	L	E	S	H	L	E	S	H	L	E	S	H	L
2.5	5	7.5	8	5	7.5	8	10	7.5	8	8	10	7.5	8	8	10
7.5	10	14	26	10	14	26	35	14	20	26	35	14	20	26	35
16	20	26	30	20	26	38	55	20	26	38	55	20	26	38	55
18	22	30	31	22	30	42	55	22	30	42	55	22	30	42	55
35	50	50	50	50	65	85	100	50	65	85	100	50	65	85	100
5	10	15	15	10	15	20	30	10	15	20	30	10	15	20	30
100	100	75	50	100	100	100	100	100	100	100	100	100	100	100	100
4	8	13	14	8	13	14	17	8	13	14	17	8	13	14	17
13	17	28	55	17	28	55	74	17	28	55	74	17	28	55	74
32	40	55	63	40	55	80	121	40	55	80	121	40	55	80	121
36	47	63	66	47	63	89	121	47	63	89	121	47	63	89	121
74	105	105	105	105	143	187	220	105	143	187	220	105	143	187	220
8	17	30	30	17	30	40	63	17	30	40	63	17	30	40	63
30,000				30,000				25,000				25,000			
10,000				10,000				10,000				10,000			
10×In				10×In				10×In				10×In			
●				●				●				●			
●				●				●				●			
●				●				●				●			
●				●				●				●			
●				●				●				●			
●				●				●				●			
●				●				●				●			
●				●				●				●			
● (3P Only)				● (3P Only)				● (3P Only)				● (3P Only)			
● (3P Only)				● (3P Only)				● (3P Only)				● (3P Only)			
● (3P Only)				● (3P Only)				-				-			
● (3P Only)				● (3P Only)				-				-			
● (2, 3P Only)				● (3P Only)				-				-			
●				●				●				●			
●				●				●				●			
●				●				●				●			
-				-				●				●			
Terminal Screw Horizontal/Vertical Switchgear (Line & Load, Line Only), Distribution Panel								Terminal Screw, Terminal Bus Bar Horizontal/Vertical Switchgear (Line & Load, Line Only)							
Possible if DIN Rail adaptor is be used				-				-				-			
75				90				105				105			
130				155				165				165			
68				68				68				68			
0.8				1.0				1.3				1.3			
232 Page				232 Page				232 Page				232 Page			
149 / 166 Page				150 / 167 Page				151 / 168 Page				151 / 168 Page			

# Model Selection Table

## Motor Protection Circuit Breakers (HGM MO Type) : 400 ~ 800 AF

### Common Ratings

Rated Insulation Voltage, Ui	1,000 V	Suitability for Isolation	Yes
Rated Operational Voltage, Ue	690 V	Utilization Category	A
Rated Impulse Withstand Voltage, Uimp	8 kV	Pollution Degree	3
Protection Function	Instantaneous, Short-Circuit Protection	Reference Standard	IEC 60947-2

Model Name	HGM400				HGM630				HGM800						
Frame (AF)	400				630				800						
Number of Poles (P)	3				3				3						
Rated Current, at 40 °C (A)	250, 300, 350, 400				500, 630				700, 800						
Rated Ultimate Short-Circuit Breaking Capacity [Icu] (kA rms)															
Short-Circuit Breaking Category Code	E	S	H	L	E	S	H	L	S	H	L				
AC 660/690 V	5	8	10	14	5	8	10	14	8	10	14				
AC 480/500 V	18	35	50	65	25	45	50	65	45	50	65				
AC 440/460 V	38	50	70	85	38	50	70	85	50	70	85				
AC 380/415 V	45	65	85	100	45	65	85	100	65	85	100				
AC 220/240 V	50	75	100	125	50	75	100	125	75	100	125				
DC 250 V (2P)	20	25	40	40	20	25	40	40	25	40	40				
Service Breaking Capacity [Ics = % Icu]	100	100	100	100	100	100	100	100	100	100	100				
Rated Short-Circuit Making Capacity [Icm] (kA peak)															
AC 660/690 V	8	14	17	28	8	14	17	28	14	17	28				
AC 480/500 V	36	74	105	143	53	95	105	143	95	105	143				
AC 440/460 V	80	105	154	187	80	105	154	187	105	154	187				
AC 380/415 V	95	143	187	220	95	143	187	220	143	187	220				
AC 220/240 V	105	165	220	275	105	165	220	275	165	220	275				
DC 250 V (2P)	40	53	84	84	40	53	84	84	53	84	84				
Endurance [times] (Durability)															
Mechanical	4,000				2,500				2,500						
Electrical (at 460 V)	1,000				500				500						
Trip Device															
Magnetic	Instantaneous [INST]				10×In				10×In						
Accessory															
Internal	Auxiliary Switch	AUX	●				●				●				
	Alarm Switch	ALT	●				●				●				
	Shunt Trip	SHT	●				●				●				
	Under-Voltage Trip	UVT	●				●				●				
External	Rotary Handle	Front Contact	TFG	●				●				●			
		Extension	TFH	●				●				●			
	Mechanical Open/Close Device	MOT	●				●				●				
	Mechanical Interlock	MIF	●				●				●				
	Handle Locking Device	PLD	●				●				●				
	Plug-in	TDM (LINE/LOAD)	● (3P Only)				● (3P Only)				● (3P Only)				
		TDM (LINE Only)	● (3P Only)				● (3P Only)				● (3P Only)				
		TDF (LINE Only)	-				-				-				
		TDA (1 row)	-				-				-				
		TDA (2 rows)	-				-				-				
Cage Terminal Block	CTB	●				●				●					
Terminal Cover	TCF	●				●				●					
Insulation Barrier	TQQ	●				●				●					
Terminal Bus Bar	TBB	●				●				●					
Installation and Dimensions															
Connection/Installation	Front Connection	Terminal Screw				Terminal Screw, Terminal Bus Bar									
	Rear Connection	Horizontal/Vertical Cable				Horizontal/Vertical Cable									
Dimension (mm)	Plug-in	Switchgear (Line & Load, Line Only)				Switchgear (Line & Load, Line Only)									
	a (3P)	140				210									
	b	257				280									
	c	110				110									
Weight (kg)	3P	4.5				9.5									
Detailed Rating and Selection	232 Page				232 Page				232 Page						
Characteristic Curve and Appearance	151 / 169 Page				152 / 170 Page				152 / 170 Page						



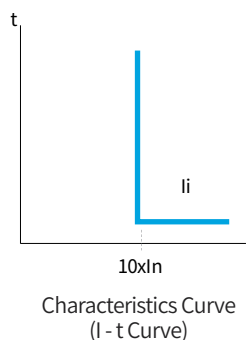

### Trip Unit Characteristics - Thermal Magnetic

Rated Current (A) In		40	50	63	75	80	100	125
MCCB	HGM50	●	●					
	HGM60	●	●	●				
	HGM100	●	●	●	●	●	●	
	HGM125	●	●	●	●	●	●	●
Instantaneous Characteristics li								
Setting Value (A)	10× In	400	500	630	750	800	1,000	1,250
	Max. Non-Tripping Current (A)	320	400	504	600	640	800	1,000
	Min. Tripping Current (A)	480	600	756	900	960	1,200	1,500

Rated Current (A) In		100	125	150	160	175	200	225	250	300	350	400	500	630	700	800
MCCB	HGM160	●	●	●	●											
	HGM250	●	●	●	●	●	●	●								
	HGM400								●	●	●	●				
	HGM630												●	●		
	HGM800														●	●
Instantaneous Characteristics li																
Setting Value (A)	10× In	1,000	1,250	1,500	1,600	1,750	2,000	2,250	2,500	3,000	3,500	4,000	5,000	6,300	7,000	8,000
	Max. Non-Tripping Current (A)	800	1,000	1,200	1,280	1,400	1,600	1,800	2,000	2,400	2,800	3,200	4,000	5,040	5,600	6,400
	Min. Tripping Current (A)	1,200	1,500	1,800	1,920	2,100	2,400	2,700	3,000	3,600	4,200	4,800	6,000	7,560	8,400	9,600

# Model Selection Table

## ZCT Embedded Molded Case Circuit Breaker (HGM Type) : 32 ~ 250 AF

As a model with a built-in ZCT in MCCB, it is a device that detects grounding when connected to an external ELR (Earth Leakage Relay) that can enhance reliability.

### Common Ratings

Rated Insulation Voltage, Ui	1,000 V	Suitability for Isolation	Yes
Rated Operational Voltage, Ue	690 V	Utilization Category	A
Rated Impulse Withstand Voltage, Uimp	8 kV	Pollution Degree	3
Protection Function	Overload, Instantaneous, Short-Circuit Protection	Reference Standard	IEC 60947-2

Model Name	HGM30	HGM50				HGM60					
Frame (AF)	32	50				63					
Number of Poles (P)	2 <sup>2)</sup> , 3, 4 <sup>1)</sup>	2 <sup>2)</sup> , 3, 4 <sup>1)</sup>				2 <sup>2)</sup> , 3, 4 <sup>1)</sup>					
Rated Current, at 40°C (A)	16, 20, 25, 32	16, 20, 25, 32, 40, 50				16, 20, 25, 32, 40, 50, 63					
Rated Ultimate Short-Circuit Breaking Capacity [Icu] (kA rms)											
Short-Circuit Breaking Category Code	E	S	E	S	H	L	E	S	H	L	
AC 660/690 V	2.5	5	2.5	5	8	10	2.5	5	7.5	8	
AC 480/500 V	7.5	10	7.5	10	26	35	7.5	10	14	26	
AC 415/440/460 V	16	20	16	20	38	55	16	20	26	30	
AC 380 V	18	22	18	22	42	55	18	22	30	31	
AC 220/240 V	35	50	35	50	85	100	35	50	50	50	
Service Breaking Capacity [Ics = % Icu]	100	100	100	100	100	100	100	100	75	50	
Rated Short-Circuit Making Capacity [Icm] (kA peak)											
AC 660/690 V	4	8	4	8	14	17	4	8	13	14	
AC 480/500 V	13	17	13	17	55	74	13	17	28	55	
AC 415/440/460 V	32	40	32	40	80	121	32	40	55	63	
AC 380 V	36	47	36	47	89	121	36	47	63	66	
AC 220/240 V	74	105	74	105	187	220	74	105	105	105	
DC 250 V (2P)	8	17	8	17	40	63	8	17	30	30	
Endurance [times] (Durability)											
Mechanical	30,000		30,000				30,000				
Electrical (at 460 V)	10,000		10,000				10,000				
ZCT Output Characteristics	200 mA/100 mV		200 mA/100 mV				200 mA/100 mV				
Trip Device											
Thermal	Long Time [LTD]	(1.0) × In		(1.0) × In				(1.0) × In			
Magnetic	Instantaneous [INST]	400 A		16 ~ 32 A : 400 A, 40 ~ 50 A : 10 × In				16 ~ 32 A : 400 A, 40 ~ 63 A : 10 × In			
Accessory											
Internal	Auxiliary Switch	AUX	●		●				●		
	Alarm Switch	ALT	●		●				●		
	Shunt Trip	SHT	●		●				●		
	Under-Voltage Trip	UVT	●		●				●		
	Rotary Handle	Front Contact TFG	●		●				●		
External	Handle	Extension TFH	●		●				●		
		Mechanical Open/Close Device MOT	●		●				●		
	Plug-in	Mechanical Interlock MIF	●		●				●		
		Handle Locking Device PLD	●		●				●		
		TDM (LINE/LOAD)	● (3P Only)		● (3P Only)		● (3P Only)		● (3P Only)		
		TDM (LINE Only)	● (3P Only)		● (3P Only)		● (3P Only)		● (3P Only)		
		TDF (LINE Only)	● (3P Only)		● (3P Only)		● (3P Only)		● (3P Only)		
	Cage Terminal Block	TDA (1 row)	● (3P Only)		● (3P Only)		● (3P Only)		● (3P Only)		
		TDA (2 rows)	● (2, 3P Only)		● (2, 3P Only)		● (3P Only)		● (2, 3P Only)		
	Terminal Cover	CTB	●		●				●		
Insulation Barrier	TCF	●		●				●			
Terminal Bus Bar	TQQ	●		●				●			
	TBB	-		-				-			
Installation and Dimensions											
Connection/Installation	Front Connection	Terminal Screw									
	Rear Connection	Horizontal/Vertical									
Dimension (mm)	Plug-in	Switchgear (Line & Load, Line Only), Distribution Panel									
	DIN Rail Installation	Possible if DIN Rail adaptor is used			-		Possible if DIN Rail adaptor is used				
	a (2/3/4P)	75/75/100	75/75/100	90/90/120	75/75/100						
	b	130	130	155	130						
Weight (kg)	c	68	68	68	68						
	2/3/4P	0.7/0.8/1.0	0.7/0.8/1.0	0.9/1.0/1.3	0.7/0.8/1.0						
Detailed Rating and Selection	232 Page		232 Page		232 Page		232 Page				
Characteristic Curve and Appearance	149 / 166 Page		149 / 166 Page		150 / 167 Page		149 / 166 Page				

※ 1) 4 Pole Arrangement : Basic specification of R-S-T-N

2) As for 2P products, only the neutral pole in the 3P product has been eliminated so the dimension is equivalent to the 3P product.

HGM100				HGM125				HGM160				HGM250			
100				125				160				250			
2 <sup>2)</sup> , 3, 4 <sup>1)</sup>				2 <sup>2)</sup> , 3, 4 <sup>1)</sup>				2 <sup>2)</sup> , 3, 4 <sup>1)</sup>				2 <sup>2)</sup> , 3, 4 <sup>1)</sup>			
16, 20, 25, 32, 40, 50, 63, 75, 80, 100				16, 20, 25, 32, 40, 50, 63, 75, 80, 100, 125				100, 125, 150, 160				100, 125, 150, 160, 175, 200, 225, 250			
E	S	H	L	E	S	H	L	E	S	H	L	E	S	H	L
2.5	5	7.5	8	5	7.5	8	10	7.5	8	8	10	7.5	8	8	10
7.5	10	14	26	10	14	26	35	14	20	26	35	14	20	26	35
16	20	26	30	20	26	38	55	20	26	38	55	20	26	38	55
18	22	30	31	22	30	42	55	22	30	42	55	22	30	42	55
35	50	50	50	50	65	85	100	50	65	85	100	50	65	85	100
100	100	75	50	100	100	100	100	100	100	100	100	100	100	100	100
4	8	13	14	8	13	14	17	8	13	14	17	8	13	14	17
13	17	28	55	17	28	55	74	17	28	55	74	17	28	55	74
32	40	55	63	40	55	80	121	40	55	80	121	40	55	80	121
36	47	63	66	47	63	89	121	47	63	89	121	47	63	89	121
74	105	105	105	105	143	187	220	105	143	187	220	105	143	187	220
8	17	30	30	17	30	40	63	17	30	40	63	17	30	40	63
30,000				30,000				25,000				25,000			
10,000				10,000				10,000				10,000			
200 mA/100 mV				200 mA/100 mV				200 mA/100 mV				200 mA/100 mV			
(1.0)×In				(1.0)×In				(1.0)×In				(1.0)×In			
16 ~ 32 A : 400 A, 40 ~ 100 A : 10×In				16 ~ 32 A : 400 A, 40 ~ 125 A : 10×In				10×In				10×In			
●				●				●				●			
●				●				●				●			
●				●				●				●			
●				●				●				●			
●				●				●				●			
●				●				●				●			
●				●				●				●			
●				●				●				●			
●				●				●				●			
● (3P Only)				● (3P Only)				● (3P Only)				● (3P Only)			
● (3P Only)				● (3P Only)				● (3P Only)				● (3P Only)			
● (3P Only)				● (3P Only)				-				-			
● (3P Only)				● (3P Only)				-				-			
● (2, 3P Only)				● (3P Only)				-				-			
●				●				●				●			
●				●				●				●			
●				●				●				●			
-				-				●				●			
Terminal Screw Horizontal/Vertical								Terminal Screw, Terminal Bus Bar Horizontal/Vertical							
Switchgear (Line & Load, Line Only), Distribution Panel								Switchgear (Line & Load, Line Only)							
Possible if DIN Rail adaptor is used								-							
75/75/100				90/90/120				105/105/140				105/105/140			
130				155				165				165			
68				68				68				68			
0.7/0.8/1.0				0.9/1.0/1.3				1.1/1.3/1.7				1.1/1.3/1.7			
232 Page				232 Page				232 Page				232 Page			
149 / 166 Page				150 / 167 Page				151 / 168 Page				151 / 168 Page			

# Model Selection Table

## ZCT Embedded Molded Case Circuit Breaker (HGM Type) : 400 ~ 800 AF

### Common Ratings

Rated Insulation Voltage, Ui	1,000 V	Suitability for Isolation	Yes
Rated Operational Voltage, Ue	690 V	Utilization Category	A
Rated Impulse Withstand Voltage, Uimp	8 kV	Pollution Degree	3
Protection Function	Overload, Instantaneous, Short-Circuit Protection	Reference Standard	IEC 60947-2

Model Name	HGM400				HGM630				HGM800					
Frame (AF)	400				630				800					
Number of Poles (P)	2 <sup>2)</sup> , 3, 4 <sup>1)</sup>				2 <sup>2)</sup> , 3				2 <sup>2)</sup> , 3					
Rated Current, at 40 °C (A)	250, 300, 350, 400				500, 630				700, 800					
Rated Ultimate Short-Circuit Breaking Capacity [Icu] (kA rms)														
Short-Circuit Breaking Category Code														
AC 660/690 V	E	S	H	L	E	S	H	L	S	H	L			
AC 480/500 V	5	8	10	14	5	8	10	14	8	10	14			
AC 440/460 V	38	50	70	85	38	50	70	85	50	70	85			
AC 380/415 V	45	65	85	100	45	65	85	100	65	85	100			
AC 220/240 V	50	75	100	125	50	75	100	125	75	100	125			
Service Breaking Capacity [Ics = % Icu]	100	100	100	100	100	100	100	100	100	100	100			
Rated Short-Circuit Making Capacity [Icm] (kA peak)														
AC 660/690 V	8	14	17	28	8	14	17	28	14	17	28			
AC 480/500 V	36	74	105	143	53	95	105	143	95	105	143			
AC 440/460 V	80	105	154	187	80	105	154	187	105	154	187			
AC 380/415 V	95	143	187	220	95	143	187	220	143	187	220			
AC 220/240 V	105	165	220	275	105	165	220	275	165	220	275			
DC 250 V (2P)	40	53	84	84	40	53	84	84	53	84	84			
Endurance [times] (Durability)														
Mechanical	4,000				2,500				2,500					
Electrical (at 460 V)	1,000				500				500					
ZCT Output Characteristics	200 mA/100 mV				200 mA/100 mV				200 mA/100 mV					
Trip Device														
Thermal	Long time [LTD]	(1.0) × In				(1.0) × In				(1.0) × In				
Magnetic	Instantaneous [INST]	10 × In				10 × In				10 × In				
Accessory														
Internal	Auxiliary Switch	AUX	●				●				●			
	Alarm Switch	ALT	●				●				●			
	Shunt Trip	SHT	●				●				●			
	Under-Voltage Trip	UVT	●				●				●			
Rotary Handle	Front Contact	TFG	●				●				●			
	Extension	TFH	●				●				●			
Mechanical Open/Close Device	MOT	●				●				●				
Mechanical Interlock	MIF	●				●				●				
Handle Locking Device	PLD	●				●				●				
External	Plug-in	TDM (LINE/LOAD)	● (3P Only)				● (3P Only)				● (3P Only)			
		TDM (LINE Only)	● (3P Only)				● (3P Only)				● (3P Only)			
		TDF (LINE Only)	-				-				-			
		TDA (1 row)	-				-				-			
		TDA (2 rows)	-				-				-			
Cage Terminal Block	CTB	●				●				●				
Terminal Cover	TCF	●				●				●				
Insulation Barrier	TQQ	●				●				●				
Terminal Bus Bar	TBB	●				●				●				
Installation and Dimensions														
Connection/Installation	Front Connection	Terminal Screw				Terminal Screw, Terminal Bus Bar								
	Rear Connection	Horizontal/Vertical Cable				Horizontal/Vertical Cable								
	Plug-in	Switchgear (Line & Load, Line Only)				Switchgear (Line & Load, Line Only)								
Dimension (mm)		a (2/3/4P)	140/140/184				210/210				210/210			
		b	257				280				280			
		c	110				110				110			
Weight (kg)	2/3/4P	4/4.5/5.4				8.7/9.5				8.7/9.5				
Detailed Rating and Selection	232 Page				232 Page				232 Page					
Characteristic Curve and Appearance	151 / 169 Page				152 / 170 Page				152 / 170 Page					

※ 1) 4 Pole Arrangement : Basic specification of R-S-T-N

2) As for 2P products, only the neutral pole in the 3P product has been eliminated so the dimension is equivalent to the 3P product.



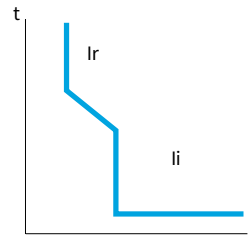

Characteristic Curve (I - t Curve)

**Trip Unit Characteristics - Thermal Magnetic**

Rated Current (A) In		16	20	25	32	40	50	63	75	80	100	125
MCCB	HGM30	●	●	●	●							
	HGM50	●	●	●	●	●	●					
	HGM60	●	●	●	●	●	●	●				
	HGM100	●	●	●	●	●	●	●	●	●	●	
	HGM125	●	●	●	●	●	●	●	●	●	●	●
Moment Characteristics Ir												
Setting Value (A)	1.0 × In	16	20	25	32	40	50	63	75	80	100	125
Instantaneous Characteristics Ii												
Setting Value (A)	10 × In (Min. 400 A)			400			500	630	750	800	1,000	1,250
	Max. Non-Tripping Current (A)			320			400	504	600	640	800	1,000
	Min. Operational Current (A)			480			600	756	900	960	1,200	1,500
Neutral Pole Protection												
4P3D		Unprotected										
4P4D		-										

Rated Current (A) In		100	125	150	160	175	200	225	250	300	350	400	500	630	700	800
MCCB	HGM160	●	●	●	●											
	HGM250	●	●	●	●	●	●	●	●							
	HGM400								●	●	●	●				
	HGM630												●	●		
	HGM800														●	●
Moment Characteristics Ir																
Setting Value (A)	1.0 × In	100	125	150	160	175	200	225	250	300	350	400	500	630	700	800
Instantaneous Characteristics Ii																
Setting Value (A)	10 × In	1,000	1,250	1,500	1,600	1,750	2,000	2,250	2,500	3,000	3,500	4,000	5,000	6,300	7,000	8,000
	Max. Non-Tripping Current (A)	800	1,000	1,200	1,280	1,400	1,600	1,800	2,000	2,400	2,800	3,200	4,000	5,040	5,600	6,400
	Min. Operational Current (A)	1,200	1,500	1,800	1,920	2,100	2,400	2,700	3,000	3,600	4,200	4,800	6,000	7,560	8,400	9,600
Neutral Pole Protection																
4P3D		Unprotected														
4P4D		-														

# Model Selection Table

## Earth Leakage Circuit Breaker (HGE Type) : 32 ~ 250 AF

### Common Ratings

Rated Operational Voltage, Ue	AC 220/460 V	Suitability for Isolation	Yes
Usable Voltage Range	AC 187 ~ 506 V	Utilization Category	A
Rated Impulse Withstand Voltage, Uimp	6 kV	Pollution Degree	3
Protection Function	Earth Leakage, Overload, Instantaneous, Short-Circuit Protection	Reference Standard	IEC 60947-2

Model Name		HGE30	HGE50	HGE60							
Frame	(AF)	32	50	63							
Number of Poles	(P)	2 <sup>2)</sup> , 3, 4 <sup>1)</sup>	2 <sup>2)</sup> , 3, 4 <sup>1)</sup>	2 <sup>2)</sup> , 3, 4 <sup>1)</sup>							
Rated Current, at 40 °C	(A)	16, 20, 25, 32	16, 20, 25, 32, 40, 50	16, 20, 25, 32, 40, 50, 63							
<b>High Speed Type</b>											
Adjustable Residual Current	(mA)	30	30	30							
Max. Operational Time	(s)	0.1	0.1	0.1							
<b>Time Delay Type</b>											
Adjustable Residual Current	(mA)	100 - 300 - 500 - 1,000 Adjustable	100 - 300 - 500 - 1,000 Adjustable	100 - 300 - 500 - 1,000 Adjustable							
Maximum Operational Time	(s)	0.1 - 0.4 - 1.0 - 2.0	0.1 - 0.4 - 1.0 - 2.0	0.1 - 0.4 - 1.0 - 2.0							
Inertial Delay Time	(ms)	0 - 200 - 500 - 1,000 Adjustable	0 - 200 - 500 - 1,000 Adjustable	0 - 200 - 500 - 1,000 Adjustable							
<b>Rated Ultimate Short-Circuit Breaking Capacity [Icu] (kA rms)</b>											
<b>Short-Circuit Breaking Category Code</b>											
AC 415/440/460 V	E	S	E	S	H	L	E	S	H	L	
AC 380 V	16	22	18	22	42	55	18	22	30	31	
AC 220/240V	35	50	35	50	85	100	35	50	50	50	
Service Breaking Capacity [Ics = % Icu]	100	100	100	100	100	100	100	100	75	50	
<b>Rated Short-Circuit Making Capacity [Icm] (kA peak)</b>											
AC 415/440/460 V	32	40	32	40	80	121	32	40	55	63	
AC 380 V	36	47	36	47	89	121	36	47	63	66	
AC 220/240 V	74	105	74	105	187	220	74	105	105	105	
<b>Endurance [times] (Durability)</b>											
Mechanical		30,000	30,000	30,000	30,000	30,000	30,000	30,000	30,000	30,000	
Electrical (at 460 V)		10,000	10,000	10,000	10,000	10,000	10,000	10,000	10,000	10,000	
<b>Trip Device</b>											
Thermal	Long Time [LTD]	(1.0)×In	(1.0)×In	(1.0)×In	(1.0)×In	(1.0)×In	(1.0)×In	(1.0)×In	(1.0)×In	(1.0)×In	
Magnetic	Instantaneous [INST]	400 A	16 ~ 32 A : 400 A, 40, 50 A : 10×In	16 ~ 32 A : 400 A, 40, 50 A : 10×In	16 ~ 32 A : 400 A, 40, 50 A : 10×In	16 ~ 32 A : 400 A, 40, 50 A : 10×In	16 ~ 32 A : 400 A, 40, 50 A : 10×In	16 ~ 32 A : 400 A, 40, 50 A : 10×In	16 ~ 32 A : 400 A, 40, 50 A : 10×In	16 ~ 32 A : 400 A, 40, 50 A : 10×In	
<b>Accessory</b>											
Internal	Auxiliary Switch	AUX	●	●	●	●	●	●	●	●	
	Alarm Switch	ALT	●	●	●	●	●	●	●	●	
	Shunt Trip	SHT	-	-	-	-	-	-	-	-	
	Under-Voltage Trip	UVT	-	-	-	-	-	-	-	-	
External	Rotary Handle	Front Contact TFG	●	●	●	●	●	●	●	●	
		Extension TFH	●	●	●	●	●	●	●	●	
	Mechanical Open/Close Device	MOT	●	●	●	●	●	●	●	●	
	Mechanical Interlock	MIF	●	●	●	●	●	●	●	●	
	Handle Locking Device	PLD	●	●	●	●	●	●	●	●	
	Plug-in	TDM (LINE/LOAD)	● (3P Only)	● (3P Only)	● (3P Only)	● (3P Only)	● (3P Only)	● (3P Only)	● (3P Only)	● (3P Only)	● (3P Only)
		TDM (LINE Only)	● (3P Only)	● (3P Only)	● (3P Only)	● (3P Only)	● (3P Only)	● (3P Only)	● (3P Only)	● (3P Only)	● (3P Only)
		TDF (LINE Only)	● (3P Only)	● (3P Only)	● (3P Only)	● (3P Only)	● (3P Only)	● (3P Only)	● (3P Only)	● (3P Only)	● (3P Only)
		TDA (1 row)	● (3P Only)	● (3P Only)	● (3P Only)	● (3P Only)	● (3P Only)	● (3P Only)	● (3P Only)	● (3P Only)	● (3P Only)
		TDA (2 rows)	● (2, 3P Only)	● (2, 3P Only)	● (2, 3P Only)	● (2, 3P Only)	● (2, 3P Only)	● (2, 3P Only)	● (2, 3P Only)	● (2, 3P Only)	● (2, 3P Only)
	Cage Terminal Block	CTB	●	●	●	●	●	●	●	●	●
Terminal Cover	TCF	●	●	●	●	●	●	●	●	●	
Insulation Barrier	TQQ	●	●	●	●	●	●	●	●	●	
Terminal Bus Bar	TBB	-	-	-	-	-	-	-	-	-	
<b>Installation and Dimensions</b>											
Connection/ Installation	Front Connection	Terminal Screw									
	Rear Connection	Horizontal/Vertical									
	Plug-in	Switchgear (Line & Load, Line Only), Distribution Panel									
Dimension (mm)	DIN Rail Installation	Possible if DIN Rail adaptor is used			-			Possible if DIN Rail adaptor is used			
	a (2/3/4P)	75/75/100	75/75/100	90/90/120	75/75/100	75/75/100	75/75/100	75/75/100	75/75/100	75/75/100	
	b	130	130	155	130	130	130	130	130	130	
	c	68	68	68	68	68	68	68	68	68	
Weight (kg)	2/3/4P	0.8/0.9/1.3	0.8/0.9/1.3	1.0/1.1/1.4	0.8/0.9/1.3	0.8/0.9/1.3	1.0/1.1/1.4	0.8/0.9/1.3	0.8/0.9/1.3	0.8/0.9/1.3	
Detailed Rating and Selection		232 Page		232 Page		232 Page		232 Page		232 Page	
Characteristic Curve and Appearance		149 / 171 Page		149 / 171 Page		150 / 172 Page		149 / 171 Page		149 / 171 Page	

※ 1) 4 Pole Arrangement : Basic specification of R-S-T-N

2) As for 2P products, only the neutral pole in the 3P product has been eliminated so the dimension is equivalent to the 3P product.

HGE100				HGE125				HGE160				HGE250			
100				125				160				250			
2 <sup>2)</sup> , 3, 4 <sup>1)</sup>				2 <sup>2)</sup> , 3, 4 <sup>1)</sup>				2 <sup>2)</sup> , 3, 4 <sup>1)</sup>				2 <sup>2)</sup> , 3, 4 <sup>1)</sup>			
16, 20, 25, 32, 40, 50, 63, 75, 80, 100				16, 20, 25, 32, 40, 50, 63, 75, 80, 100, 125				100, 125, 150, 160				100, 125, 150, 160, 175, 200, 225, 250			
30				30				30				30			
0.1				0.1				0.1				0.1			
100 - 300 - 500 - 1,000 Adjustable				100 - 300 - 500 - 1,000 Adjustable				100 - 300 - 500 - 1,000 Adjustable				100 - 300 - 500 - 1,000 Adjustable			
0.1 - 0.4 - 1.0 - 2.0				0.1 - 0.4 - 1.0 - 2.0				0.1 - 0.4 - 1.0 - 2.0				0.1 - 0.4 - 1.0 - 2.0			
0 - 200 - 500 - 1,000 Adjustable				0 - 200 - 500 - 1,000 Adjustable				0 - 200 - 500 - 1,000 Adjustable				0 - 200 - 500 - 1,000 Adjustable			
E	S	H	L	E	S	H	L	E	S	H	L	E	S	H	L
16	20	26	30	20	26	38	55	20	26	38	55	20	26	38	55
18	22	30	31	22	30	42	55	22	30	42	55	22	30	42	55
30	50	50	50	50	65	85	100	50	65	85	100	50	65	85	100
100	100	75	50	100	100	100	100	100	100	100	100	100	100	100	100
32	40	55	63	40	55	80	121	40	55	80	121	40	55	80	121
36	47	63	66	47	63	89	121	47	63	89	121	47	63	89	121
74	105	105	105	105	143	187	220	105	143	187	220	105	143	187	220
30,000				30,000				25,000				25,000			
10,000				10,000				10,000				10,000			
(1.0)×In				(1.0)×In				(1.0)×In				(1.0)×In			
16 ~ 32 A : 400 A, 40 ~ 100 A : 10×In				16 ~ 32 A : 400 A, 40 ~ 125 A : 10×In				10×In				10×In			
●				●				●				●			
●				●				●				●			
-				-				-				-			
●				●				●				●			
●				●				●				●			
●				●				●				●			
●				●				●				●			
●				●				●				●			
● (3P Only)				● (3P Only)				● (3P Only)				● (3P Only)			
● (3P Only)				● (3P Only)				● (3P Only)				● (3P Only)			
● (3P Only)				● (3P Only)				-				-			
● (3P Only)				● (3P Only)				-				-			
● (2, 3P Only)				● (3P Only)				-				-			
●				●				●				●			
●				●				●				●			
●				●				●				●			
-				-				●				●			
Terminal Screw Horizontal/Vertical								Terminal Screw, Terminal Bus Bar Horizontal/Vertical							
Switchgear (Line & Load, Line Only), Distribution Panel								Switchgear (Line & Load, Line Only)							
Possible if DIN Rail adaptor is used								-							
75/75/100				90/90/120				105/105/140				105/105/140			
130				155				165				165			
68				68				68				68			
0.8/0.9/1.3				1.0/1.1/1.4				1.3/1.5/1.9				1.3/1.5/1.9			
232 Page				232 Page				232 Page				232 Page			
149 / 171 Page				150 / 172 Page				151 / 173 Page				151 / 173 Page			

# Model Selection Table

## Earth Leakage Circuit Breaker (HGE Type) : 400 ~ 800 AF

### Common Ratings

Rated Operational Voltage, Ue	AC 220/460 V	Suitability for Isolation	Yes
Usable Voltage Range	AC 187 ~ 506 V	Utilization Category	A
Rated Impulse Withstand Voltage, Uimp	6 kV	Pollution Degree	3
Protection Function	Earth Leakage, Overload, Instantaneous, Short-Circuit Protection	Reference Standard	IEC 60947-2

Model Name		HGE400	HGE630	HGE800
Frame (AF)		400	630	800
Number of Poles (P)		2 <sup>2)</sup> , 3, 4 <sup>1)</sup>	2 <sup>2)</sup> , 3	2 <sup>2)</sup> , 3
Rated Current, at 40 °C (A)		250, 300, 350, 400	500, 630	700, 800
<b>High Speed Type</b>				
Adjustable Residual Current (mA)		30	30	30
Max. Operational Time (s)		0.1	0.1	0.1
<b>Time Delay Type</b>				
Adjustable Residual Current (mA)		100 - 300 - 500 - 1,000 Adjustable	100 - 300 - 500 - 1,000 Adjustable	100 - 300 - 500 - 1,000 Adjustable
Max. Operational Time (s)		0.1 - 0.4 - 1.0 - 2.0	0.1 - 0.4 - 1.0 - 2.0	0.1 - 0.4 - 1.0 - 2.0
Inertial Delay Time (ms)		0 - 200 - 500 - 1,000 Adjustable	0 - 200 - 500 - 1,000 Adjustable	0 - 200 - 500 - 1,000 Adjustable
<b>Rated Ultimate Short-Circuit Breaking Capacity [Icu] (kA rms)</b>				
Short-Circuit Breaking Category Code		E S H L	E S H L	E S H L
AC 440/460 V		38 50 70 85	38 50 70 85	50 70 85
AC 380/415 V		45 65 85 100	45 65 85 100	65 85 100
AC 220/240 V		50 75 100 125	50 75 100 125	75 100 125
Service Breaking Capacity [Ics = % Icu]		100 100 100 100	100 100 100 100	100 100 100
<b>Rated Short-Circuit Making Capacity [Icm] (kA peak)</b>				
AC 440/460 V		80 105 154 187	80 105 154 187	105 154 187
AC 380/415 V		95 143 187 220	95 143 187 220	143 187 220
AC 220/240 V		105 165 220 275	105 165 220 275	165 220 275
<b>Endurance [times] (Durability)</b>				
Mechanical		4,000	2,500	2,500
Electrical (at 460 V)		1,000	500	500
<b>Trip Device</b>				
Thermal	Long Time [LTD]	(1.0) × In	(1.0) × In	(1.0) × In
Magnetic	Instantaneous [INST]	10 × In	10 × In	10 × In
<b>Accessory</b>				
Internal	Auxiliary Switch AUX	●	●	●
	Alarm Switch ALT	●	●	●
	Shunt Trip SHT	●	●	●
	Under-Voltage Trip UVT	●	●	●
External	Rotary Handle	●	●	●
	Front Contact TFG	●	●	●
	Extension TFG	●	●	●
	Mechanical Open/Close Device MOT	●	●	●
	Mechanical Interlock MIF	●	●	●
	Handle Locking Device PLD	●	●	●
	Plug-in	TDM (LINE/LOAD) ● (3P Only) TDM (LINE Only) ● (3P Only) TDF (LINE Only) - TDA (1 row) - TDA (2 rows) -	● (3P Only) ● (3P Only)	● (3P Only) ● (3P Only)
Cage Terminal Block CTB	●	●	●	
Terminal Cover TCF	●	●	●	
Insulation Barrier TQQ	●	●	●	
Terminal Bus Bar TBB	●	●	●	
<b>Installation and Dimensions</b>				
Connection/Installation	Front Connection	Terminal Screw	Terminal Screw, Terminal Bus Bar	
	Rear Connection	Horizontal/Vertical Cable	Horizontal/Vertical Cable	
Dimension (mm)	Plug-in	Switchgear (Line & Load, Line Only)	Switchgear (Line & Load, Line Only)	
	a (2/3/4P)	140/140/184	210/210	210/210
	b	257	280	280
	c	110	110	110
Weight (kg)	3/4P	4/4.5/5.4	8.7/9.5	8.7/9.5
Detailed Rating and Selection		232 Page	232 Page	232 Page
Characteristic Curve and Appearance		151 / 174 Page	152 / 175 Page	152 / 175 Page

※ 1) 4 Pole Arrangement : Basic specification of R-S-T-N

2) As for 2P products, only the neutral pole in the 3P product has been eliminated so the dimension is equivalent to the 3P product.



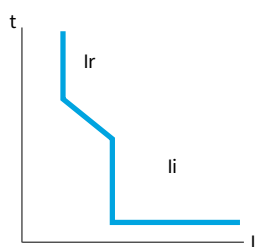

Over-Current Protection Characteristics

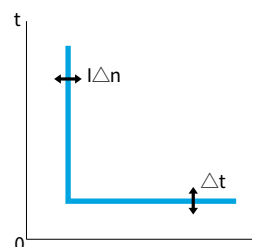

Earth Leakage Protection Characteristics (Time Delay Type)

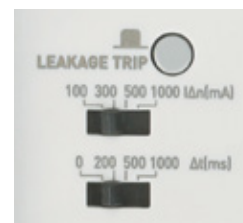

### Trip Unit Characteristics - Thermal Magnetic

Rated Current (A) In		16	20	25	32	40	50	63	75	80	100	125
ELCB	HGE30	●	●	●	●							
	HGE50	●	●	●	●	●	●					
	HGE60	●	●	●	●	●	●	●				
	HGE100	●	●	●	●	●	●	●	●	●	●	
	HGE125	●	●	●	●	●	●	●	●	●	●	●
<b>Moment Characteristics Ir</b>												
Setting Value (A)	1.0 × In	16	20	25	32	40	50	63	75	80	100	125
<b>Instantaneous Characteristics Ii</b>												
Setting Value (A)	10 × In (Min. 400 A)			400			500	630	750	800	1,000	1,250
	Max. Non-Tripping Current (A)			320			400	504	600	640	800	1,000
	Min. Operational Current (A)			480			600	756	900	960	1,200	1,500
<b>Rated Non-Operational Time IΔn</b>												
High-Speed Type		Fixed : 30 mA										
Time Delay Type		Adjustable : 100 - 300 - 500 - 1,000 mA										
<b>Inertial Propagation Time Δt</b>												
High-Speed Type		Fixed : 0 ms										
Time Delay Type		Adjustable : 0 - 200 - 500 - 1,000 ms										
<b>Neutral Pole Protection</b>												
4P3D		Unprotected										
4P4D		-										

Rated Current (A) In		100	125	150	160	175	200	225	250	300	350	400	500	630	700	800
ELCB	HGE160	●	●	●	●											
	HGE250	●	●	●	●	●	●	●	●							
	HGE400								●	●	●	●				
	HGE630												●	●		
	HGE800														●	●
<b>Moment Characteristics Ir</b>																
Setting Value (A)	1.0 × In	100	125	150	160	175	200	225	250	300	350	400	500	630	700	800
<b>Instantaneous Characteristics Ii</b>																
Setting Value (A)	10 × In	1,000	1,250	1,500	1,600	1,750	2,000	2,250	2,500	3,000	3,500	4,000	5,000	6,300	7,000	8,000
	Max. Non-Tripping Current (A)	800	1,000	1,200	1,280	1,400	1,600	1,800	2,000	2,400	2,800	3,200	4,000	5,040	5,600	6,400
	Min. Operational Current (A)	1,200	1,500	1,800	1,920	2,100	2,400	2,700	3,000	3,600	4,200	4,800	6,000	7,560	8,400	9,600
<b>Rated Non-Operational Time IΔn</b>																
High-Speed Type		Fixed : 30 mA														
Time Delay Type		Adjustable : 100 - 300 - 500 - 1,000 mA														
<b>Inertial Propagation Time Δt</b>																
High-Speed Type		Fixed : 0 ms														
Time Delay Type		Adjustable : 100 - 200 - 500 - 1,000 mA														
<b>Neutral Pole Protection</b>																
4P3D		Unprotected														
4P4D		-														

# Model Selection Table

## High Breaking Capacity Type of Molded Case Circuit Breaker (HGP Type) : 50 ~ 800 AF

### Common Ratings

Rated Insulation Voltage, Ui	1,000 V	Suitability for Isolation	Yes
Rated Operational Voltage, Ue	690 V	Utilization Category	A
Rated Impulse Withstand Voltage, Uimp	8 kV	Pollution Degree	3
Protection Function	Overload, Instantaneous, Short-Circuit Protection	Reference Standard	IEC 60947-2

Model Name	HGP50D				HGP125D				HGP160D				HGP100					
Frame (AF)	50				125				160				100					
Number of Poles (P)	3, 4 <sup>1)</sup>				3, 4 <sup>1)</sup>				3, 4 <sup>1)</sup>				3, 4 <sup>1)</sup>					
<b>Rated Ultimate Short-Circuit Breaking Capacity [Icu] (kA rms)</b>																		
Short-Circuit Breaking Category Code	F <sup>2)</sup>	S	H	X	F <sup>2)</sup>	S	H	X	F <sup>2)</sup>	S	H	X	F <sup>2)</sup>	S	H	X		
AC 660/690 V	6	8	8	10	6	8	8	10	6	8	8	10	6	8	8	10		
AC 480/500 V	25	50	65	100	25	50	65	100	25	50	65	100	25	50	65	100		
AC 440/460 V	36	65	85	150	36	65	85	150	36	65	85	150	36	65	85	150		
AC 380/415 V	50	85	100	150	50	85	100	150	50	85	100	150	50	85	100	150		
AC 220/240 V	65	100	130	200	65	100	130	200	65	100	130	200	65	100	130	200		
DC 250 V <sup>3)</sup>	36	65	85	100	36	65	85	100	36	65	85	100	36	65	85	100		
Service Breaking Capacity [Ics = % Icu]	100	100	100	100	100	100	100	100	100	100	100	100	100	100	100	100		
<b>Rated Short-Circuit Making Capacity [Icm] (kA peak)</b>																		
AC 660/690 V	9	14	14	17	9	14	14	17	9	14	14	17	9	14	14	17		
AC 480/500 V	53	105	143	220	53	105	143	220	53	105	143	220	53	105	143	220		
AC 440/460 V	76	143	187	330	76	143	187	330	76	143	187	330	76	143	187	330		
AC 380/415 V	105	187	220	330	105	187	220	330	105	187	220	330	105	187	220	330		
AC 220/240 V	143	220	286	440	143	220	286	440	143	220	286	440	143	220	286	440		
<b>Endurance [times] (Durability)</b>																		
Mechanical	25,000				25,000				25,000				25,000					
In @ 440V	10,000				10,000				10,000				10,000					
<b>Trip Device</b>																		
● ● ● ●																		
Thermal Magnetic	Rated Current, at 40 °C (A)	16, 20, 25, 32, 40, 50				16, 20, 25, 32, 40, 50, 63, 75, 80, 100, 125				100, 125, 160				40, 50, 63, 80, 100				
	Long Time [LTD]	(0.8-0.9-1.0)×In				(0.8-0.9-1.0)×In				(0.8-0.9-1.0)×In				(0.7-0.8-0.9-1.0)×In				
	Instantaneous [INST]	16~32 A : 400 A, 40~50 A : 10×In				16~32 A : 400 A, 40~50 A : 10×In				10×In				10×In				
Electronic	Rated Current, at 40 °C (A)	-				-				-				● 40, 100				
	Long Time [LTD]	Ir (A)	N, D, A, E				-				-				0.4-0.45-0.5-0.56-0.63-0.7-0.8-0.9-1×In			
		Tr (s)	N				-				-				16 @ 6Ir			
	Short Time [STD]	Isd (A)	N, D, A, E				-				-				1.5-2-3-4-5-6-7-8-10×In			
		Tsd (s)	N				-				-				0.1			
	Instantaneous [INST]	Ii (A)	N				-				-				1,500			
		Break time (s)	D, A, E				-				-				1.5-2-4-6-8-10-11-12-13-14-15×In			
	Ground Fault Protection [GFT]	Ig (A)	N				-				-				0.05			
		Tg (ms)	D, A, E				-				-				NA			
	N Pole Protection (L, S)	(A)	N, D, A, E				-				-				OFF-0.2-0.3-0.4-0.5-0.6-0.7-0.8-1×In			
<b>Installation and Dimensions</b>																		
Connection/ Installation	Front Connection	Terminal Screw				Terminal Screw				Terminal Screw				Terminal Screw, Terminal Bus Bar				
	Rear Connection	Horizontal/Vertical Cable				Horizontal/Vertical Cable				Horizontal/Vertical Cable				Horizontal/Vertical Cable				
	Plug-in	Switchgear (Line & Load, Line Only)				Switchgear (Line & Load, Line Only)				Switchgear (Line & Load, Line Only)				Switchgear (Line & Load, Line Only)				
Dimension (mm)	a (3/4P)	90/120				90/120				90/120				105/140				
	b	140				140				140				165				
	c	86				86				86				86.5				
Weight (kg)	3/4P	1.5/1.8				1.5/1.8				1.5/1.8				2/2.6				
Detailed Rating and Selection		234				234				234				234				
Characteristic Curve and Appearance		156 / 176				156 / 176				156 / 176				157 <sup>5)</sup> / 177				

※ 1) 4 Pole Arrangement : Basic specification of R-S-T-N  
 2) Only applicable to oversea products/ship products  
 3) DC is only applicable to thermal magnetic

4) Only applicable if Ir < 0.63 ("1" is applicable if Ir ≥ 0.63)  
 5) The characteristic curve of electronic MCCB : 161 ~ 163 page

Accessory	
Internal	Auxiliary switch (AUX), Alarm switch (ALT), Shunt trip (SHT), Undervoltage trip (UVT)
External	Rotary handle - Front Contact Type (TFG)/Extension Type (TFH), Motor operator (MOT), Mechanical interlock (MIF), Locking device (PLD), Cage terminal block (CTB), Insulation terminal cover (TCF), Insulation barrier (TQQ) ※ Plug-in TDM is only for 3 pole and can be selected by LINE/LODE(P3), LINE Only(F3).Terminal extensions (TBB) excludes HGP50D, 125D and 160D types.

HGP160				HGP250				HGP400				HGP630				HGP800			
160 3, 4 <sup>1)</sup>				250 3, 4 <sup>1)</sup>				400 3, 4 <sup>1)</sup>				630 3, 4 <sup>1)</sup>				800 3, 4 <sup>1)</sup>			
F*2)	S	H	X	F*2)	S	H	X	F*2)	S	H	X	F*2)	S	H	X	F*2)	S	H	X
6	8	8	10	6	8	8	10	10	10	20	35	10	10	20	35	10	10	20	35
25	50	65	100	25	50	65	100	25	50	70	100	25	50	70	100	25	50	70	100
36	65	85	150	36	65	85	150	36	70	85	150	36	70	85	150	36	70	85	150
50	85	100	150	50	85	100	150	50	85	100	150	50	85	100	150	50	85	100	150
65	100	130	200	65	100	130	200	65	100	130	200	65	100	130	200	65	100	130	200
36	65	85	100	36	65	85	100	36	65	85	100	36	65	85	100	36	65	85	100
100	100	100	100	100	100	100	100	100	100	100	100	100	100	100	100	100	100	100	100
9	14	14	17	9	14	14	17	17	17	40	74	17	17	40	74	17	17	40	74
53	105	143	220	53	105	143	220	53	105	154	220	53	105	154	220	53	105	154	220
76	143	187	330	76	143	187	330	76	154	187	330	76	154	187	330	76	154	187	330
105	187	220	330	105	187	220	330	105	187	220	330	105	187	220	330	105	187	220	330
143	220	286	440	143	220	286	440	143	220	286	440	143	220	286	440	143	220	286	440
25,000				25,000				20,000				20,000				10,000			
10,000				10,000				6,000				4,000				3,000			
●				●				●				●				●			
100, 125, 150, 160				125, 150, 160, 175, 200, 225, 250				300, 350, 400				500, 630				700, 800			
(0.7-0.8-0.9-1.0)×In				(0.7-0.8-0.9-1.0)×In				(0.8-0.9-1.0)×In				(0.8-0.9-1.0)×In				(0.8-0.9-1.0)×In			
(5-6-7-8-9-10)×In				(5-6-7-8-9-10)×In				(5-6-7-8-9-10)×In				(5-6-7-8-9-10)×In				(5-6-7-8-9-10)×In			
●				●				●				●				●			
100, 160				160, 250				250, 400				630				800			
0.4-0.45-0.5-0.56-0.63-0.7-0.8-0.9-1×In				0.4-0.45-0.5-0.56-0.63-0.7-0.8-0.9-1×In				0.4-0.45-0.5-0.56-0.63-0.7-0.8-0.9-1×In				0.4-0.45-0.5-0.56-0.63-0.7-0.8-0.9-1×In				0.4-0.45-0.5-0.56-0.63-0.7-0.8-0.9-1×In			
16 @ 6lr				16 @ 6lr				16 @ 6lr				16 @ 6lr				16 @ 6lr			
0.5-1-2-4-6-8-16 @ 6×lr				0.5-1-2-4-6-8-16 @ 6×lr				0.5-1-2-4-6-8-16 @ 6×lr				0.5-1-2-4-6-8-16 @ 6×lr				0.5-1-2-4-6-8-16 @ 6×lr			
1.5-2-3-4-5-6-7-8-10×In				1.5-2-3-4-5-6-7-8-10×In				1.5-2-3-4-5-6-7-8-10×In				1.5-2-3-4-5-6-7-8-10×In				1.5-2-3-4-5-6-7-8-10×In			
0.1				0.1				0.1				0.1				0.1			
0.1-0.2-0.3-0.4				0.1-0.2-0.3-0.4				0.1-0.2-0.3-0.4				0.1-0.2-0.3-0.4				0.1-0.2-0.3-0.4			
1,500 @ 100 A, 2,400 @ 160 A				2,400 @ 160 A, 3,000 A @ 250 A				3,000 @ 250 A, 4,800 @ 400 A				6,900				8,800			
1.5-2-4-6-8-10-11-12-13-14-15×In				1.5-2-4-6-8-10-11×In				1.5-2-4-6-8-10-11×In				1.5-2-4-6-8-10-11×In				1.5-2-4-6-8-10-11×In			
0.05				0.05				0.05				0.05				0.05			
NA				NA				NA				NA				NA			
OFF-0.2-0.3-0.4-0.5-0.6-0.7-0.8-1×In				OFF-0.2-0.3-0.4-0.5-0.6-0.7-0.8-1×In				OFF-0.2-0.3-0.4-0.5-0.6-0.7-0.8-1×In				OFF-0.2-0.3-0.4-0.5-0.6-0.7-0.8-1×In				OFF-0.2-0.3-0.4-0.5-0.6-0.7-0.8-1×In			
NA				NA				NA				NA				NA			
0.1-0.2-0.3-0.4				0.1-0.2-0.3-0.4				0.1-0.2-0.3-0.4				0.1-0.2-0.3-0.4				0.1-0.2-0.3-0.4			
OFF-0.5-1-1.6 <sup>4)</sup> ×In				OFF-0.5-1-1.6 <sup>4)</sup> ×In				OFF-0.5-1-1.6 <sup>4)</sup> ×In				OFF-0.5-1-1.6 <sup>4)</sup> ×In				OFF-0.5-1-1.6 <sup>4)</sup> ×In			
Terminal Screw, Terminal Bus Bar				Terminal Screw, Terminal Bus Bar				Terminal Screw, Terminal Bus Bar				Terminal Screw, Terminal Bus Bar				Terminal Screw, Terminal Bus Bar			
Horizontal/Vertical Cable				Horizontal/Vertical Cable				Horizontal/Vertical Cable				Horizontal/Vertical Cable				Horizontal/Vertical Cable			
Switchgear (Line & Load, Line Only)				Switchgear (Line & Load, Line Only)				Switchgear (Line & Load, Line Only)				Switchgear (Line & Load, Line Only)				Switchgear (Line & Load, Line Only)			
105/140				105/140				140/186.5				140/186.5				210/280			
165				165				260				260				320			
86.5				86.5				110				110				135			
2/2.6				2/2.6				5.4/7.2				5.4/7.2				15.1/19.6			
234				234				234				234				234			
157 <sup>5)</sup> /177				157 <sup>5)</sup> /177				158 <sup>5)</sup> /178				158 <sup>5)</sup> /178				158 <sup>5)</sup> /179			

# Model Selection Table

## Trip Unit's Model Name and Function (Thermal Magnetic)

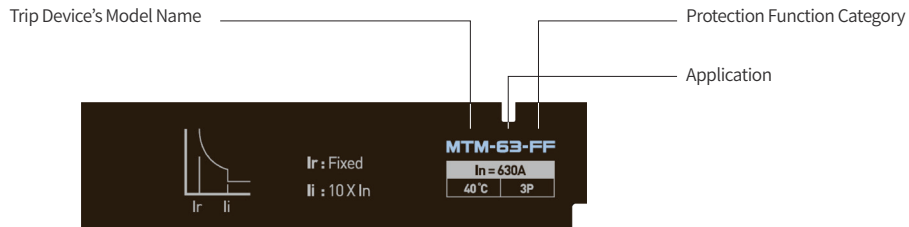

Overcurrent Protection	Instantaneous Current Protection	TRIP Unit Name								
		HGP50D	HGP125D	HGP160D	HGP100	HGP160	HGP250	HGP400	HGP630	HGP800
Fixed	Fixed		MTM - 16 - FF			MTM - 25 - FF		MTM - 63 - FF		MTM - 80 - FF
Adjustable	Fixed		MTM - 16 - JF			MTM - 25 - JF		MTM - 63 - JF		MTM - 80 - JF
Adjustable	Adjustable		-			MTM - 25 - JJ		MTM - 63 - JJ		MTM - 80 - JJ

## Trip Unit Characteristics – Thermal Magnetic HGP50D, 125D, 160D

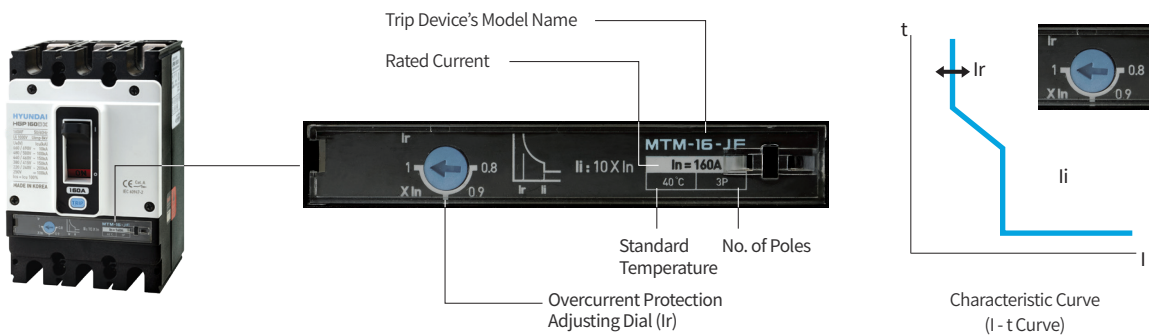

Rated Current (A) In		16	20	25	32	40	50	63	75	80	100	125	150	160	
MCCB	HGP50D	●	●	●	●	●	●								
	HGP125D	●	●	●	●	●	●	●	●	●	●	●			
	HGP160D										●	●	●	●	
	HGP100					●	●	●	●	●	●				
<b>Moment Characteristics Ir</b>															
Fixed (FF)	1.0 × In	16	20	25	32	40	50	63	75	80	100	125	150	160	
	0.7 × In <sup>1)</sup>					28 <sup>1)</sup>	35 <sup>1)</sup>	44 <sup>1)</sup>	53 <sup>1)</sup>	56 <sup>1)</sup>	70 <sup>1)</sup>				
Adjustable (JF, JJ)	0.8 × In	13	16	20	26	32	40	50	60	64	80	100	120	128	
	0.9 × In	14	18	23	29	36	45	57	68	72	90	113	135	144	
	1.0 × In	16	20	25	32	40	50	63	75	80	100	125	150	160	
<b>Instantaneous Characteristics Ii</b>															
Fixed (FF, JF)	10 × In	160	200	250	320	400	500	630	750	800	1,000	1,250	1,500	1,600	
	Max. Non-Tripping Current (A)	128	160	200	256	320	400	504	600	640	800	1,000	1,200	1,280	
	Min. Tripping Current (A)	192	240	300	384	480	600	756	900	960	1,200	1,500	1,800	1,920	
<b>Neutral Pole Protection</b>															
4P3D (Neutral Unprotected)		●	●	●	●	●	●	●	●	●	●	●	●	●	
4P4D (Neutral Protected 100 % Ir)		●	●	●	●	●	●	●	●	●	●	●	●	●	

※ 1) Only applicable to HGP100



### Trip Unit Characteristics – Thermal Magnetic HGP250, 400, 630, 800

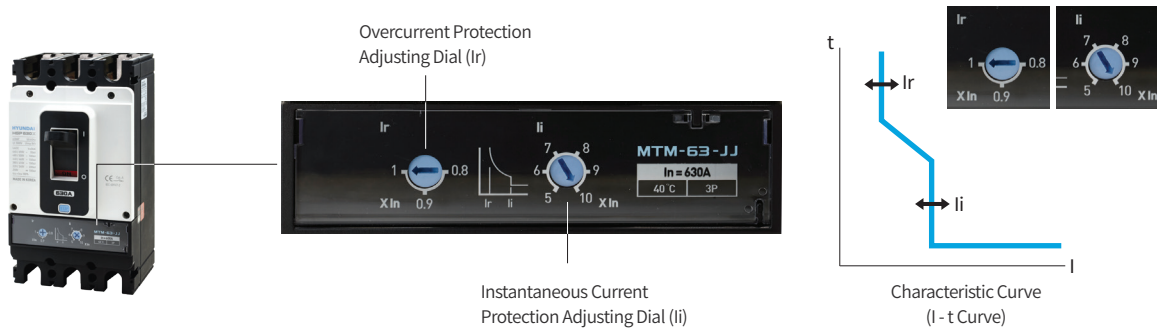

Rated Current (A) $I_n$		100	125	150	160	175	200	225	250	300	350	400	500	630	700	800		
MCCB	HGP100	● <sup>1)</sup>																
	HGP160	●	●	●	●													
	HGP250		●	●	●	●	●	●	●									
	HGP400									●	●	●						
	HGP630												●	●				
	HGP800														●	●		
<b>Moment Characteristics <math>I_r</math></b>																		
Fixed (FF)	1.0 × $I_n$	100	125	150	160	175	200	225	250	300	350	400	500	630	700	800		
Adjustable (JF, JJ)	0.7 × $I_n$	70	88	105	112	123	140	158	175									
	0.8 × $I_n$	80	100	120	128	140	160	180	200	240	280	320	400	504	560	640		
	0.9 × $I_n$	90	113	135	144	158	180	203	225	270	315	360	450	567	630	720		
	1.0 × $I_n$	100	125	150	160	175	200	225	250	300	350	400	500	630	700	800		
<b>Instantaneous Characteristics <math>I_i</math></b>																		
Fixed (FF, JF)	10 × $I_n$	1,000	1,250	1,500	1,600	1,750	2,000	2,250	2,500	3,000	3,500	4,000	5,000	6,300	7,000	8,000		
	Max. Non-Tripping Current (A)	800	1,000	1,200	1,280	1,400	1,600	1,800	2,000	2,400	2,800	3,200	4,000	5,040	5,600	6,400		
	Min. Tripping Current (A)	1,200	1,500	1,800	1,920	2,100	2,400	2,700	3,000	3,600	4,200	4,800	6,000	7,560	8,400	9,600		
Adjustable (JJ)	5 × $I_n$	500	625	750	800	875	1,000	1,125	1,250	1,500	1,750	2,000	2,500	3,150	3,500	4,000		
	Max. Non-Tripping Current (A)	400	500	600	640	700	800	900	1,000	1,200	1,400	1,600	2,000	2,520	2,800	3,200		
	Min. Tripping Current (A)	600	750	900	960	1,050	1,200	1,350	1,500	1,800	2,100	2,400	3,000	3,780	4,200	4,800		
	6 × $I_n$	600	750	900	960	1,050	1,200	1,350	1,500	1,800	2,100	2,400	3,000	3,780	4,200	4,800		
	Max. Non-Tripping Current (A)	480	600	720	768	840	960	1,080	1,200	1,440	1,680	1,920	2,400	3,024	3,360	3,840		
	Min. Tripping Current (A)	720	900	1,080	1,152	1,260	1,440	1,620	1,800	2,160	2,520	2,880	3,600	4,536	5,040	5,760		
	7 × $I_n$	700	875	1,050	1,120	1,225	1,400	1,575	1,750	2,100	2,450	2,800	3,500	4,410	4,900	5,600		
	Max. Non-Tripping Current (A)	560	700	840	896	980	1,120	1,260	1,400	1,680	1,960	2,240	2,800	3,528	3,920	4,480		
	Min. Tripping Current (A)	840	1,050	1,260	1,344	1,470	1,680	1,890	2,100	2,520	2,940	3,360	4,200	5,292	5,880	6,720		
	8 × $I_n$	800	1,000	1,200	1,280	1,400	1,600	1,800	2,000	2,400	2,800	3,200	4,000	5,040	5,600	6,400		
	Max. Non-Tripping Current (A)	640	800	960	1,024	1,120	1,280	1,440	1,600	1,920	2,240	2,560	3,200	4,032	4,480	5,120		
	Min. Tripping Current (A)	960	1,200	1,440	1,536	1,680	1,920	2,160	2,400	2,880	3,360	3,840	4,800	6,048	6,720	7,680		
	9 × $I_n$	900	1,125	1,350	1,440	1,575	1,800	2,025	2,250	2,700	3,150	3,600	4,500	5,670	6,300	7,200		
	Max. Non-Tripping Current (A)	720	900	1,080	1,152	1,260	1,440	1,620	1,800	2,160	2,520	2,880	3,600	4,536	5,040	5,760		
	Min. Tripping Current (A)	1,080	1,350	1,620	1,728	1,890	2,160	2,430	2,700	3,240	3,780	4,320	5,400	6,804	7,560	8,640		
	10 × $I_n$	1,000	1,250	1,500	1,600	1,750	2,000	2,250	2,500	3,000	3,500	4,000	5,000	6,300	7,000	8,000		
	Max. Non-Tripping Current (A)	800	1,000	1,200	1,280	1,400	1,600	1,800	2,000	2,400	2,800	3,200	4,000	5,040	5,600	6,400		
	Min. Tripping Current (A)	1,200	1,500	1,800	1,920	2,100	2,400	2,700	3,000	3,600	4,200	4,800	6,000	7,560	8,400	9,600		
	<b>Neutral Pole Protection</b>																	
	4P3D (Neutral Unprotected)		●	●	●	●	●	●	●	●	●	●	●	●	●	●	●	
4P4D (Neutral Protected 100% $I_r$ )		●	●	●	●	●	●	●	●	●	●	●	●	●	●	●		

※ 1) HGP100 100 A product is only applicable to Instantaneous fixed type.

# Model Selection Table

## Trip Unit's Model Name and Function (ETU)

ETU Part Name

LCD Display / ICON (N Type is not applicable)

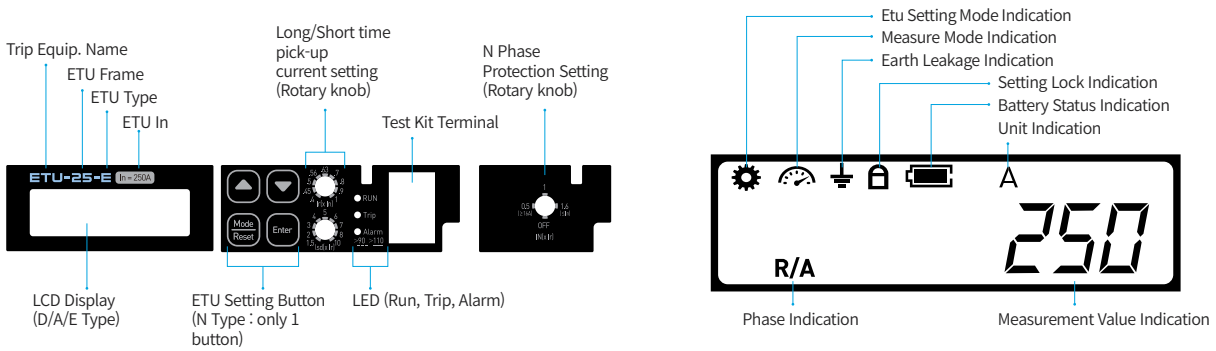

ETU Type / AF

Type	Model (AF)	Trip Unit								
		HGP100, HGP160, HGP250				HGP400		HGP630	HGP800	
	Rated Current (A)	40	100	160	250	250	400	630	800	
Normal Type			ETU-25-N				ETU-63-N		ETU-80-N	
Display Type			ETU-25-D				ETU-63-D		ETU-80-D	
Ammeter Type			ETU-25-A				ETU-63-A		ETU-80-A	
Energy-meter Type			ETU-25-E				ETU-63-E		ETU-80-E	

### Trip Unit Characteristics – Electronic Type

	N	D	A	E	Remark
HMI	Dial 2 EA	• Dial 2 EA, Key Button 4 EA • Segment LCD	• Dial 2 EA, Key Button 4 EA • Segment LCD	• Dial 2 EA, Key Button 4 EA • Segment LCD	Dial Setting (Ir, Isd)
Protection	• L (Dial) • S (Dial) • I (Fixed) • IN (Dial)	• L (Dial, Key Button) • S (Dial) • I (Key Button) • G (Key Button) • IN (Dial)	• L (Dial, Key Button) • S (Dial) • I (Key Button) • G (Key Button) • IN (Dial)	• L (Dial, Key Button) • S (Dial) • I (Key Button) • G (Key Button) • IN (Dial)	L, S time to be changed by key button
Measurement		• IR, IS, IT, IN, IG	• IR, IS, IT, IN, IG • Iavg, I <sub>max</sub> , I <sub>min</sub>	• IR, IS, IT, IN, IG, I <sub>unbalance</sub> (per phase) • Iavg, I <sub>max</sub> , I <sub>min</sub> • V, phase to neutral, phase to phase, • P, total/per phase, power factor • Q, total/per phase • S, total/per phase • Active(kW), Reactive(kVAR), Apparent(kVA) • F, THD (I, V, per phase, VLN, VLL) • Harmonic (15 th), Demand I, P	
History / Event	• 20 Trip information (damaged phase, type, time)	• 20 Trip information (damaged phase, type, time)	• 20 Trip information (damaged phase, type, time) • 32 System Event	• 20 Trip information (damaged phase, type, time) • 32 System Event	External power required DC 24 V
Power	• Self-Power	• Self-Power	• Self-Power External power input (24 V DC)	• Self-Power <sup>1)</sup> External power input (24 V DC)	
Battery	●	●	●	●	
Add-on function	• Test terminal	• Test terminal	• Test terminal • ZSI OUT : 250 AF • ZSI IN/OUT : 630 AF, 800 AF • Trip / Alarm Counter • Operating time 50 % In Over - 24 h	• Test terminal • ZSI OUT : 250 AF • ZSI IN/OUT : 630 AF, 800 AF • Trip / Alarm Counter • Operating time 50 % In Over - 24 h	External power required DC 24 V
Communication			• RS-485 MODBUS-RTU	• RS-485 MODBUS-RTU	External power required DC 24 V
Indication	• LED 3 ea • Run LED / Trip LED Alarm LED (90 % off, 110 % on)	• LED 3 ea • Run LED / Trip LED Alarm LED (90 % off, 110 % on)	• LED 3 ea • Run LED / Trip LED Alarm LED (90 % off, 110 % on)	• LED 3 ea • Run LED / Trip LED Alarm LED (90 % off, 110 % on)	

※ 1) ETU self-power active current  
Under 250A : over 30%In  
Etc. : over 15%In

## Trip Unit Overview

Type	ETUN	ETUD	ETUA	ETUE
Protection Elements				
	<ul style="list-style-type: none"> <li>• For protecting the switchgear / general industry</li> <li>• L, S, I</li> </ul>	<ul style="list-style-type: none"> <li>• For protecting the switchgear / general industry</li> <li>• L, S, I, G</li> </ul>	<ul style="list-style-type: none"> <li>• For protecting the switchgear / general industry</li> <li>• L, S, I, G</li> </ul>	<ul style="list-style-type: none"> <li>• For protecting the switchgear / general industry</li> <li>• L, S, I, G</li> </ul>
Trip Unit	250 AF 630 AF 800 AF	250 AF 630 AF 800 AF	250 AF 630 AF 800 AF	250 AF 630 AF 800 AF
	<ul style="list-style-type: none"> <li>• Use the dial to set the pick-up for LT and ST.</li> <li>• The setting of time delay has been fixed for operation.</li> </ul>	<ul style="list-style-type: none"> <li>• A user can set LT and ST pick-up with a dial.</li> <li>• A user can set the time delay for operation with a keypad.</li> <li>• A user can set a pick-up and time delay of Instantaneous and grounding operation with a keypad.</li> <li>• A user can move around information displayed on the LED window and set relaying with Menu, Up, Down, and Enter button.</li> </ul>	<ul style="list-style-type: none"> <li>• A user can set LT and ST pick-up with a dial.</li> <li>• A user can set the time delay for operation with a keypad.</li> <li>• A user can set a pick-up and time delay of Instantaneous and grounding operation with a keypad.</li> <li>• A user can move around information displayed on the LED window and set relaying with Menu, Up, Down, and Enter button.</li> </ul>	<ul style="list-style-type: none"> <li>• A user can set LT and ST pick-up with a dial.</li> <li>• A user can set the time delay for operation with a keypad.</li> <li>• A user can set a pick-up and time delay of Instantaneous and grounding operation with a keypad.</li> <li>• A user can move around information displayed on the LED window and set relaying with Menu, Up, Down, and Enter button.</li> </ul>
	LT pick-up setting ST pick-up setting	LT pick-up setting ST pick-up setting 	LT pick-up setting ST pick-up setting 	LT pick-up setting ST pick-up setting 
Setting and Display	<ul style="list-style-type: none"> <li>• It displays load and trip status, which are in use, on the LED window.</li> </ul>	<ul style="list-style-type: none"> <li>• It displays load and trip status, which are in use, on the LED window.</li> </ul>	<ul style="list-style-type: none"> <li>• It displays load and trip status, which are in use, on the LED window.</li> </ul>	<ul style="list-style-type: none"> <li>• It displays load and trip status, which are in use, on the LED window.</li> </ul>
	<ul style="list-style-type: none"> <li>• A user can check battery replacement time by pressing the keypad with the battery symbol.</li> </ul>	<ul style="list-style-type: none"> <li>• A user can check battery replacement time on the LED window.</li> </ul>	<ul style="list-style-type: none"> <li>• A user can check battery replacement time on the LED window.</li> </ul>	<ul style="list-style-type: none"> <li>• A user can check battery replacement time on the LED window.</li> </ul>

※ A battery is consumable. 6 years of use is guaranteed under normal working conditions.  
 ※ Even if the battery is discharged, the trip function of the ETU operates.

# Model Selection Table

## Trip Unit – Basic (N Type)

### Protection

#### Overload : Long Time Protection Fixed Time Delay (Ir)

It protects the system from overload through fixed operation time and adjustable setting range.

#### Short Circuit : Short time Protection Fixed Time Delay (Isd)

It protects the system from short-circuit accidents through fixed operation time and adjustable setting range.

#### Short Circuit : Instantaneous Protection (Ii)

It protects the system from short-circuit accidents with a fixed setting range.

#### Neutral Wire : Neutral Protection (Ii)

- A 3-phase circuit breaker does not protect a neutral wire.
  - In a 4-phase circuit breaker, a setting range is set with a regulating device (dial) to protect the neutral wire.
    - OFF : It does not protect a neutral wire.
    - 0.5 <sup>1)</sup> : It protects a neutral wire at 0.5 Ir (x in).
    - 1 : It protects a neutral wire at 1 Ir (x in).
    - 1.6 : It protects a neutral wire at 1.6 Ir (x in).
- However, when it exceeds 0.63 A (rated current) in the setting range, a neutral wire is protected at 1 Ir (x in).

※ 1) It is set to 16 A or higher.

### Display

#### Status LED

- RUN LED : It informs the operation status of a circuit breaker.
- Trip LED : It turns on when a circuit breaker operates.
- Alarm LED : It turns off at  $I > 0.9 \times I_r$  and turns on at  $I > 1.1 \times I_r$ .
- Battery Check : It checks battery replacement time by pressing the N-Type Battery Check button.
  - Usable : 3 LED lamps turn on.
  - Replacement Time : One Alarm LED turns on.

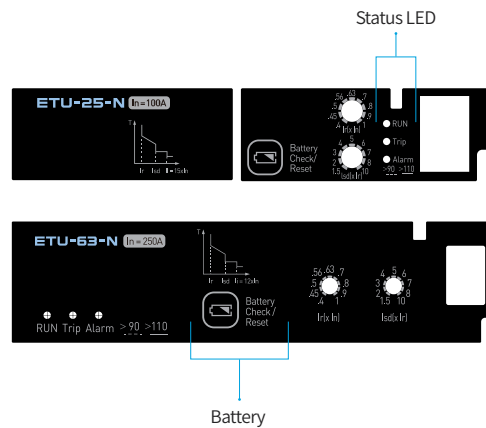

### Protection Setting Range

N Type													
	<b>L Long-Time Protection</b>												
	Pick-up [A]	$I_r = I_n \times$	Dial Setting	0.4	0.45	0.5	0.56	0.63	0.7	0.8	0.9	1	
	Time Delay [s] Accuracy $\pm 20\%$	tr =	Fixed										
			$1.5 \times I_r$	378									
$6 \times I_r$			16										
	$7.2 \times I_r$	11											
Thermal Memory		20 minutes											
<b>S Short-Time Protection</b>													
Pick-up [A] Accuracy $\pm 15\%$	$I_{sd} = I_r \times$	dial setting	1.5	2	3	4	5	6	7	8	10		
Time Delay [s]	tsd =	Fixed											
		Non Tripping Time	0.08										
		Max Time	0.14										
<b>I Instantaneous Protection</b>													
Pick-up [A] Accuracy $\pm 15\%$	Ii =	In = 40 A	600										
		In = 100 A	1,500										
		In = 160 A	2,400										
		In = 250 A	3,000										
		In = 400 A	4,800										
		In = 630 A	6,900										
	In = 800 A	8,800											
Time Delay [s]		Maximum Time	$\leq 0.05$										
<b>IN Neutral Protection</b>													
Pick-up	$I_N = I_r \times$		OFF	0.5	1	1.6							

## Trip Unit – D/A/E Type

### Protection

#### Overload : Long time Protection (Ir)

It protects the system from overload through an adjustable setting range and an operational time range.

#### Short Circuit : Short time Protection (Isd)

It protects the system from short-circuit accidents through an adjustable setting range and an operational time range.

#### Short Circuit : Instantaneous Protection (Ii)

It protects the system from short-circuit accidents with an adjustable setting range.

#### Grounding : Ground Fault Protection (I<sub>g</sub>)

It protects the system with an adjustable setting range and an operation time range. To find grounding, the residual current is detected in a circuit.

#### Neutral Wire : Neutral Protection (Ii)

- A 3-phase circuit breaker does not protect a neutral wire.
  - In a 4-phase circuit breaker, a setting range is set with a regulating device (dial) to protect the neutral wire.
    - OFF : It does not protect a neutral wire.
    - 0.5 <sup>1)</sup> : It protects a neutral wire at 0.5 I<sub>r</sub> (x in).
    - 1 : It protects a neutral wire at 1 I<sub>r</sub> (x in).
    - 1.6 : It protects a neutral wire at 1.6 I<sub>r</sub> (x in).
- However, when it exceeds 0.63 A (rated current) in the setting range, a neutral wire is protected at 1 I<sub>r</sub> (x in).

※ <sup>1)</sup> It is set to 16 A or higher.

### Display

#### Status LED

- RUN LED : It informs the operation status of a circuit breaker.
- Trip LED : It turns on when a circuit breaker operates.
- Alarm LED : It turns off at I > 0.9 x I<sub>r</sub> and turns on at I > 1.1 x I<sub>r</sub>.

#### Button

- It moves around the screens on the display and sets the trip units.
- There are 4 buttons: Up, Down, Menu/Reset, and Enter

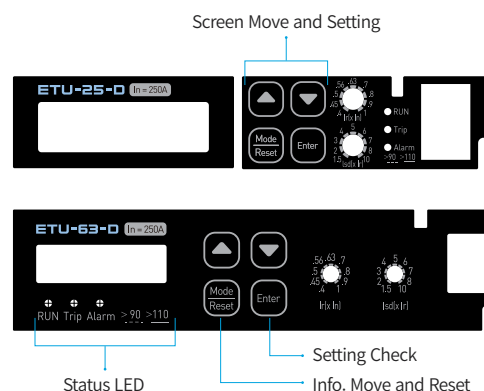

### Protection Setting Range

#### D/A/E Type

L Long-Time Protection															
	Pick-up [A]	I <sub>r</sub> = I <sub>n</sub> x	Dial Setting	0.4	0.45	0.5	0.56	0.63	0.7	0.8	0.9	1			
			Button Setting	Correction in 1 A increments. Max correction value = Dial Setting											
	Time Delay [s]		tr =	1.5 x I <sub>r</sub>	0.5	1	2	4	6	8	16				
	Accuracy ±20%			6 x I <sub>r</sub>	11.8	23.7	47.3	94.7	142	189	378				
			7.2 x I <sub>r</sub>	0.5	1	2	4	6	8	16					
Thermal Memory				345	690	1.38	2.76	4.2	5.5	11					
				20 minutes											
S Short-Time Protection															
Pick-up [A]	I <sub>sd</sub> = I <sub>r</sub> x	Dial Setting	1.5	2	3	4	5	6	7	8	10				
Accuracy ±15%		Butto	I <sup>2</sup> OFF	0.1	0.2	0.3	0.4								
		Setting	I <sup>2</sup> ON	0.1	0.2	0.3	0.4								
Time Delay [s]	tsd =	Non Tripping Time		0.08	0.14	0.23	0.35								
		Max Time		0.14	0.2	0.32	0.5								
I Instantaneous Protection															
Pick-up [A]	I <sub>i</sub> = I <sub>n</sub> x	Button Setting	In = 40 A, 100 A, 160 A	1.5	2	4	6	8	10	11	12	13	14	15	
Accuracy ±15%			In ≥ 250 A	1.5	2	4	6	8	10	11					
Time Delay [s]		Maximum Time		≤ 0.05											
In Neutral Protection															
Pick-up	I <sub>N</sub> = I <sub>r</sub> x			OFF	0.5	1	1.6								
G Ground-Fault Protection															
Pick-up [A]	I <sub>g</sub> = I <sub>n</sub> x	Button Setting		0.2	0.3	0.4	0.5	0.6	0.7	0.8	1	OFF	In > 40 A	In = 40 A	
Accuracy ±15%		Butto	I <sup>2</sup> OFF	0.4	0.5	0.6	0.7	0.8	1	OFF					
		Setting	I <sup>2</sup> ON	0.1	0.2	0.3	0.4								
Time Delay [s]	tsd =	Non Tripping Time		0.1	0.2	0.3	0.4								
		Max Time		0.08	0.14	0.23	0.35								
				0.14	0.20	0.32	0.5								

# Technical Data (ETU)

## Circuit Diagram

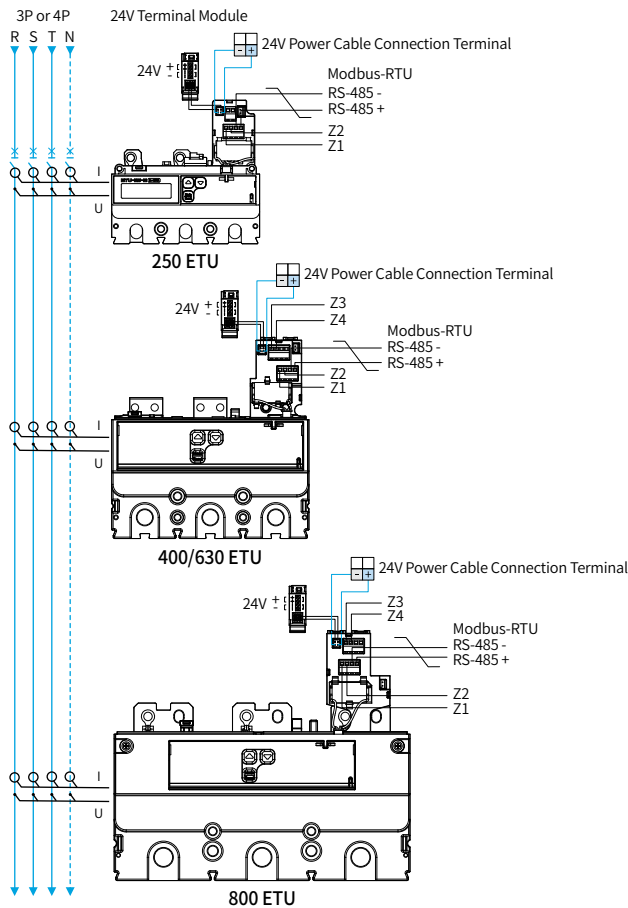

ETU A/E	
A/E	<b>Power</b> - (Black), + (Red) : 24 V DC Power Supply
	<b>ZSI (Zone Selective Interlocking)</b> Z1 : ZSI OUT 0 Z2 : ZSI OUT 1 Z3 : ZSI IN 0 Z4 : ZSI IN 1 ※ Z1-Z3 and Z2-Z4 are connected. ※ Z3 and Z4 are usable for HGP400, 630, and 800. ※ ZSI signal line to connect should not be longer than 3 meters.
E	<b>Voltage Measurement</b>

### Internal Options Related to HGP Electronic Type

Type	Image	Features	Type	Image	Features
FAL 250 AF 630 AF 800 AF		Transmits a fault signal of ETU Indicator Fault Alarm LED	DC 24 V Terminal Block		ETU Trip Unit The options for the connection of "A" and "E" type to the external power source Easy to connect a power cable between the products ※ The same purpose as DC 24 V power cable
DC 24 V Power Cable		ETU Trip Unit The options for the connection of "A" and "E" type to the external power source (DC 24 V) - 1.5 m	DC 3.6 V Battery		A replaceable battery is necessary for the function of saving the ETU time and accidents. - 10 EA vinyl packing

### External Options Related to HGP Electronic Type

Type	Image	Features
Test Kit		The external options used to test and set an electronic product.

## Trip Unit – D/A/E Type

### Display

It displays the setting info. of a trip unit and key measured values on the LCD window.

- D/A Type : Current
- E Type : Current, voltage, and energy

When it is connected with an external power source, it becomes possible to check a trip unit info. and set it even with the MCCB (molded case circuit breaker) open. The following functions activate when it is connected to an external power source.

- Connects with a communication system
- Displays trip info.

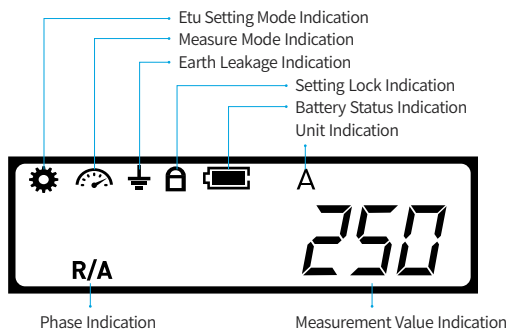

### Metering

#### Metering

The trip unit types (D, A, and E) display each phase and current to a neutral wire in RMS. A user can check information in each phase displayed with the Up and Down button.

The A type measures current and the E type provides information of voltage, power, and energy through a display device and communication.

#### Power Quality

The E type displays total harmonic distortion (THD) of load current and voltage, and 15th order harmonic waves. The relevant information is sent to a PC or a monitor through MODBUS communication.

### Test Terminal

For its maintenance, ETU has a test terminal at the front. When the test terminal is connected to the ETU test kit, it is possible to set the ETU and simulate a trip operation.

#### Test Kit Composition

- A dedicated adapter (AC 100 ~ 220 V 50/60 Hz)
- A dedicated cable to connect the ETU test terminal
- A user manual

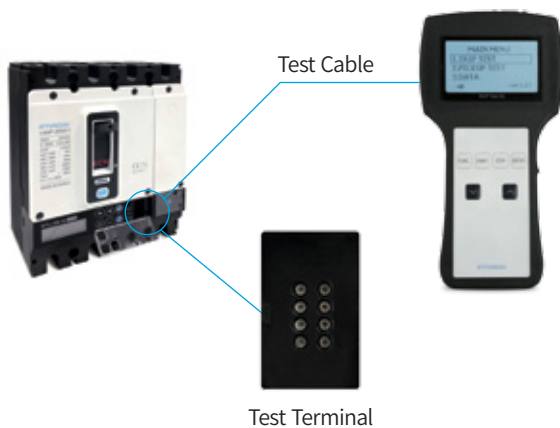

### Alarm Contact (FAL)

As an additional option, an alarm switch can be constructed only for ETU operations not connected with the MCCB trip alarm switch.

#### FAL Output Characteristics

Static Outputs : AC 100 ~ 220 V, 64 mA max

#### FAL Structure and Terminal

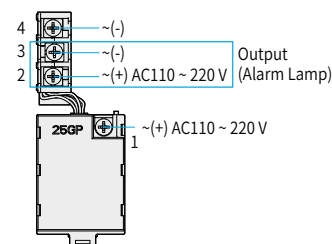

#### FAL Circuit Diagram

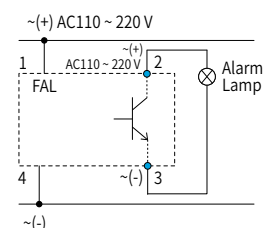

※ A lamp is not provided.

# Technical Data (ETU)

## Operation and Setting – ETU LCD

The ETU LCD provides a user with information of load status and relay settings.

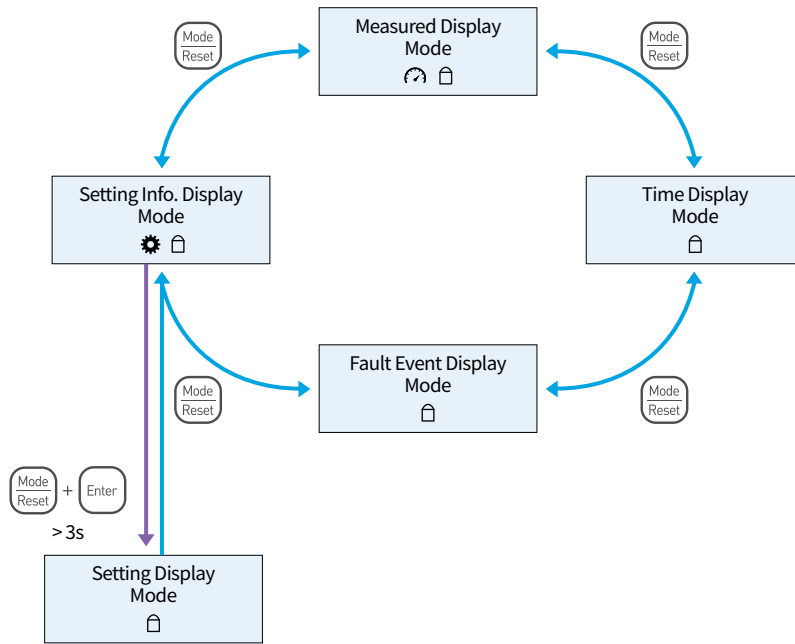

It displays current metering on the default screen.

A user can move to the metering screen to display with the buttons.

In case there is information on phases in the metering screen, it turns sequentially (phase after phase) every 3 seconds.

With the button, a user can move around the screens (Current, Voltage, Power, and Energy).

### Metering Display

Model	Mode	Order	Description
D/A/E		1	Instantaneous Current I1 R/A  A <b>250</b>
		2	Instantaneous Current I2 S/B  A <b>250</b>
		3	Instantaneous Current I3 T/C  A <b>250</b>
		4	Instantaneous Neutral Current IN (4P or with ENCT) N  A <b>0</b>
		5	Instantaneous Ground Current Ig A <b>20</b>

Model	Mode	Order	Description
E		6	Phase to Phase Voltage U12 R/A S/B  V <b>380</b>
		7	Phase to Phase Voltage U23 S/B T/C  V <b>380</b>
		8	Phase to Phase Voltage U31 R/A T/C  V <b>380</b>
		9	Phase to Phase Voltage V1N R/A  V <b>220</b>
		10	Phase to Phase Voltage V2N S/B  V <b>220</b>



### Metering Display

Model	Mode	Order	Description
E		11	Phase to Phase Voltage V3N T/C <b>220</b> V
		12	Total Active Power Ptot R/A S/B T/C <b>605.7</b> kW
		13	Total Reactive Power Qtot R/A S/B T/C <b>199.1</b> kVAR
		14	Total Apparent Power Stot R/A S/B T/C <b>637.5</b> kVA

Model	Mode	Order	Description
E		15	Active Energy Ep (readout and reset) R/A S/B T/C <b>123.3</b> kWh
		16	Reactive Energy Eq (readout and reset) R/A S/B T/C <b>123.1</b> kVARh
		17	Apparent Energy Es (readout and reset) R/A S/B T/C <b>233.1</b> kVA h

### Setting Information Display

A user can check the relay settings on the default display screen with the button.

A user moves around the setting screens with the .

Model	Mode	Order	Description
D/A/E		1	Ir Long Time Protection Pickup Value R/A S/B T/C <b>250</b> A
		2	Ir Long Time Protection Neutral Pickup Value (4P or with ENCT) N <b>125</b> A
		3	tr Long Time Protection Time Delay @ 6 Ir Tr= <b>2</b> s
		4	Isd Short Time Protection Pickup Value R/A S/B T/C <b>500</b> A
		5	Isd Short Time Protection Neutral Pickup Value (4P or with ENCT) N <b>500</b> A
		6	tsd Short Time Protection Time Delay - ON : I <sup>2</sup> t Active - OFF : I <sup>2</sup> t Reactive Tsd= <b>OFF.1</b> s Tsd= <b>0n.4</b> s

Model	Mode	Order	Description
D/A/E		7	Ii Instantaneous Protection Pickup Value (N phase is display when it is 4P or with ENCT.) R/A S/B T/C <b>1260</b> A N R/A S/B T/C <b>1260</b> A
		8	Ig Ground Fault Protection Pickup Value Ig= <b>50</b> A
		9	tg Ground Fault Protection Time Delay Value - ON : I <sup>2</sup> t Active - OFF : I <sup>2</sup> t Reactive Tg= <b>OFF.1</b> s Tg= <b>0n.4</b> s
		10	Communication Address : 1 ~ 250 <b>2001</b>
		11	Communication Baud Rate b 9.6 : 9600 bps b 19.2 : 19200 bps b 38.4 : 38400 bps Ir= <b>6 9.6</b>

# Technical Data (ETU)

## Operation and Setting – ETU LCD

### Setting Information Display

Model	Mode	Order	Description
D/A/E		12	Thermal ON/OFF ON/OFF Check

### Setting Change Screen

To change the ETU settings, keep pressing the two buttons + for more than 3 seconds and the Lock symbol disappears. Then a user can change the settings. When no entry has been made for 10 seconds or the button is pressed, the Lock symbol is displayed automatically. A user moves around the setting screens with the buttons. (Mode : )

1. Relay Setting			
1	Ir Setting Screen 	+  > 3 Seconds Hold The Lock Symbol Disappears.	
1.1	The Lock Symbol Not Seen 	Flashing + The State of Changing The Settings	
1.2	Ir Setting 	Setting The Current Value a User Wants Step 1 A Fine Adjustment and Dial Adjustment (~ Max Dial Settings)	
1.3	Saving Ir Settings 	Saving The Settings	
2	tr Setting Screen 	Move Flashing + The State of Changing The Settings	
2.1	tr Setting and Saving 	Setting the desired trip time. : 0.5 ~ 16 Saving The Settings	
3	Isd Setting Screen Move 	Move	











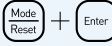









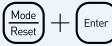

## Setting Change Screen

1. Relay Setting			
3.1	Isd Setting Screen 		Pickup Range Dial Setting : 1.5 ~ 10 
4	tsd Setting Screen 		Move Flashing + The State of Changing The Settings 
4.1	tsd Setting and Saving 	 	Time Delay Setting - OFF.1 : I <sup>2</sup> t OFF 0.1 s - On.4 : I <sup>2</sup> t ON 0.4 s Saving The Settings 
5	Ig Setting 	 	Move Flashing + The State of Changing The Settings 
5.1	Ig Setting and Saving 	 	Pickup Range : 0.2 ~ 1×In Saving The Settings 
6	tg Setting 	 	Move Flashing + The State of Changing The Settings 
6.1	tg Setting and Saving 	 	Time Delay Setting : 0.1 ~ 0.4 - OFF.1 : I <sup>2</sup> t OFF 0.1 s - On.4 : I <sup>2</sup> t ON 0.4 s Saving The Settings 
7	Ii Setting 	 	Move Flashing + The State of Changing The Settings 
7.1	Ii Setting and Saving 	 	Pickup Range : 1.5 ~ 11×In N is displayed when it is 4P or with ENCT. Saving The Settings 
8	IN Setting 		Move Setting with The Pickup Range Dial OFF - 0.5 - 1 - 1.6 

# Technical Data (ETU)

## Operation and Setting – ETU LCD

### Setting Change Screen

2. Communication Settings Address (A/E)			
9	Communication Address Setting Screen 	 > 3 Seconds Hold The Lock Symbol Disappears.	
9.1	The Lock Symbol Disappears. 	 Flashing + The State of Changing The Settings	
9.2	Setting 	 Address Setting : 1 ~ 250	
9.3	Saving Settings 	 Save	
10	Communication Baud Rate Setting Screen 	 > 3 Seconds Hold The Lock Symbol Disappears.	
10.1	The Lock Symbol Disappears. 	 Flashing + The State of Changing The Settings	
10.2	Setting 	 Setting The Desired Communication Speed. b 9.6 : 9600 bps b 19.2 : 19200 bps b 38.4 : 38400 bps	
10.3	Saving Settings 	 Save	

### Setting Change Screen

Basically, the MCCB has thermal characteristics. The thermal functions are aimed to prevent a fire caused by heat and a device from it by simulating the thermal energy of a bus-bar, which runs at a regular phase.

When a user wants to deactivate the functions in a certain situation, he or she can do so by setting on the setting screen as follows.

3. Thermal On/Off (A/E)			
11	Thermal On/Off Screen 	Move Setting Display	
11.1	Thermal On/Off Setting 	Flashing + The State of Changing The Settings Setting Change - ON : Thermal ON - OFF : Thermal OFF I <sup>2</sup> t Applying	
11.2	Thermal On/Off Saving 	Save	
11.3	Thermal On/Off Screen 	Move The Screen	

### Reset

Energy Reset (Active, Reactive, Apparent) E Type			
1	Energy Metering Screen 	+  > 3 Seconds Hold The Lock Symbol Disappears.	
2	The Lock Symbol Disappears. 	A Measured Value Flashes.	
3	Energy Reset 	Energy Values Reset.	
6	Return to The Energy Metering Screen 		

# Model Selection Table

## Motor Protection Type of Molded Case Circuit Breaker (HGP Type) : 100 ~ 800 AF

The circuit breaker for motor protection is a circuit breaker for instantaneous trip (magnetic only) equipped with instantaneous and short circuit protection functions only, it is suitable for protecting the motor by assembling it together with the overcurrent relay/ electronic connector.

### Common Ratings

Rated Insulation Voltage, Ui	1,000 V	Suitability for Isolation	Yes
Rated Operational Voltage, Ue	690 V	Utilization Category	A
Rated Impulse Withstand Voltage, Uimp	8 kV	Pollution Degree	3
Protection Function	Instantaneous, Short-Circuit Protection	Reference Standard	IEC 60947-2

Model Name	HGP100				HGP250					
Frame (AF)	100				250					
Number of Poles (P)	3				3					
Rated Current, at 40 °C (A)	2.5, 3.2, 6.3, 12.5, 20, 32, 50, 63, 80, 100				125, 150, 175, 200, 225, 250					
<b>Rated Short-Circuit Breaking Capacity [Icu] (kA rms)</b>										
Short-Circuit Breaking Category Code	F* 1)	S	H	X	F* 1)	S	H	X		
AC 660/690 V	6	8	8	10	6	8	8	10		
AC 480/500 V	25	50	65	100	25	50	65	100		
AC 440/460 V	36	65	85	150	36	65	85	150		
AC 380/415 V	50	85	100	150	50	85	100	150		
AC 220/240 V	65	100	130	200	65	100	130	200		
Service Breaking Capacity [Ics = % Icu]	100	100	100	100	100	100	100	100		
<b>Rated Short-Circuit Making Capacity [Icm] (kA peak)</b>										
AC 660/690 V	9	14	14	17	9	14	14	17		
AC 480/500 V	53	105	143	220	53	105	143	220		
AC 440/460 V	76	143	187	330	76	143	187	330		
AC 380/415 V	105	187	220	330	105	187	220	330		
AC 220/240 V	143	220	286	440	143	220	286	440		
<b>Endurance [times] (Durability)</b>										
Mechanical	25,000				25,000					
In @ 440 V	10,000				10,000					
<b>Trip Device</b>										
Thermal Magnetic	Long Time [LTD]	●				●				
	Instantaneous [INST]	(6 - 7 - 8 - 9 - 10 - 11 - 12 - 13 - 14) × In				(5 - 6 - 7 - 8 - 9 - 10) × In				
Electronic	Long Time [LTD]	-				-				
	Short Time [STD]	-				-				
	Instantaneous [INST]	-				-				
<b>Accessory</b>										
Internal	Auxiliary Switch AUX	●				●				
	Alarm Switch ALT	●				●				
	Shunt Trip SHT	●				●				
	Under-Voltage Trip UVT	●				●				
	Rotary Handle	Front Contact TFG	●				●			
		Extension TFG	●				●			
Mechanical Open/Close Device MOT	●				●					
Mechanical Interlock MIF	●				●					
External	Handle Locking Device PLD	●				●				
		●				●				
	Plug-in	TDM (LINE/LOAD)	● (3P Only)				● (3P Only)			
		TDM (LINE Only)	● (3P Only)				● (3P Only)			
	Cage Terminal Block CTB	●				●				
	Terminal Cover TCF	●				●				
Insulation Barrier TQQ	●				●					
Terminal Bus Bar TBB	●				●					
<b>Installation and Dimensions</b>										
Connection/Installation	Front Connection	Terminal Screw, Terminal Bus Bar			Terminal Screw, Terminal Bus Bar					
	Rear Connection	Horizontal/Vertical Cable			Horizontal/Vertical Cable					
Dimension (mm)	Plug-in	Switchgear (Line & Load, Line Only)			Switchgear (Line & Load, Line Only)					
	a	105			105					
	b	165			165					
	c	86.5			86.5					
Weight (kg)	3/4P	2/2.6			2/2.6					
Detailed Rating and Selection		234 Page			234 Page					
Characteristic Curve and Appearance		157 / 177 Page			157 / 177 Page					

※ 1) F type is for overseas sales.

HGP400				HGP630				HGP800			
400				630				800			
3				3				3			
350, 400				500, 630				700, 800			
F* 1)	S	H	X	F* 1)	S	H	X	F* 1)	S	H	X
10	10	20	35	10	10	20	35	10	10	20	35
25	50	70	100	25	50	70	100	25	50	70	100
36	70	85	150	36	70	85	150	36	70	85	150
50	85	100	150	50	85	100	150	50	85	100	150
65	100	130	200	65	100	130	200	65	100	130	200
100	100	100	100	100	100	100	100	100	100	100	100
17	17	40	74	17	17	40	74	17	17	40	74
53	105	154	220	53	105	154	220	53	105	154	220
76	154	187	330	76	154	187	330	76	154	187	330
105	187	220	330	105	187	220	330	105	187	220	330
143	220	286	440	143	220	286	440	143	220	286	440
20,000				20,000				10,000			
6,000				4,000				3,000			
●				●				●			
-				-				-			
(5 - 6 - 7 - 8 - 9 - 10) × In				(5 - 6 - 7 - 8 - 9 - 10) × In				(5 - 6 - 7 - 8 - 9 - 10) × In			
-				-				-			
-				-				-			
-				-				-			
●				●				●			
●				●				●			
●				●				●			
●				●				●			
●				●				●			
●				●				●			
●				●				●			
●				●				●			
●				●				●			
●				●				●			
●				●				●			
●				●				●			
●				●				●			
●				●				●			
●				●				●			
● (3P Only)				● (3P Only)				● (3P Only)			
● (3P Only)				● (3P Only)				● (3P Only)			
●				●				●			
●				●				●			
●				●				●			
●				●				●			
Terminal Screw, Terminal Bus Bar				Terminal Screw, Terminal Bus Bar				Terminal Screw, Terminal Bus Bar			
Horizontal/Vertical Cable				Horizontal/Vertical Cable				Horizontal/Vertical Cable			
Switchgear (Line & Load, Line Only)				Switchgear (Line & Load, Line Only)				Switchgear (Line & Load, Line Only)			
140				140				210			
260				260				320			
110				110				135			
5.4/7.2				5.4/7.2				15.1/19.6			
234 Page				234 Page				234 Page			
158 / 178 Page				158 / 178 Page				158 / 179 Page			

# Model Selection Table

## Trip Unit Characteristics

Model Selection Table

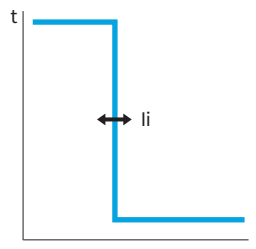
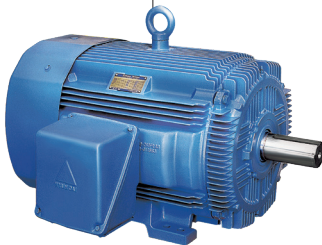

Characteristic Curve (I - t Curve)





Rated Current (A) In		2.5	3.2	6.3	12.5	20	32	50	63	80	100
MCCB	HGP100	●	●	●	●	●	●	●	●	●	●
Instantaneous Setting Current (A)											
9 Step Adjustable	6×Ir	15	19.2	37.8	75	120	192	300	378	480	600
	7×Ir	17.5	22.4	44.1	87.5	140	224	350	441	560	700
	8×Ir	20	25.6	50.4	100	160	256	400	504	640	800
	9×Ir	22.5	28.8	56.7	112.5	180	288	450	567	720	900
	10×Ir	25	32	63	125	200	320	500	630	800	1,000
	11×Ir	27.5	35.2	69.3	137.5	220	352	550	693	880	1,100
	12×Ir	30	38.4	75.6	150	240	384	600	756	960	1,200
	13×Ir	32.5	41.6	81.9	162.5	260	416	650	819	1,040	1,300
	14×Ir	35	44.8	88.2	175	280	448	700	882	1,120	1,400
Accuracy		Within ± 20 %									

Rated Current (A) In		125	150	175	200	225	250	350	400	500	630	700	800
MCCB	HGP250	●	●	●	●	●	●						
	HGP400							●	●				
	HGP630									●	●		
	HGP800											●	●
Instantaneous Setting Current (A)													
6 Step Adjustable	5×Ir	625	750	875	1,000	1,125	1,250	1,750	2,000	2,500	3,150	3,500	4,000
	6×Ir	750	900	1,050	1,200	1,350	1,500	2,100	2,400	3,000	3,780	4,200	4,800
	7×Ir	875	1,050	1,225	1,400	1,575	1,750	2,450	2,800	3,500	4,410	4,900	5,600
	8×Ir	1,000	1,200	1,400	1,600	1,800	2,000	2,800	3,200	4,000	5,040	5,600	6,400
	9×Ir	1,125	1,350	1,575	1,800	2,025	2,250	3,150	3,600	4,500	5,670	6,300	7,200
	10×Ir	1,250	1,500	1,750	2,000	2,250	2,500	3,500	4,000	5,000	6,300	7,000	8,000
Accuracy		Within ± 20 %											

# Model Selection Table

## Switch Disconnectors (HGP NA Type) : 50 ~ 800 AF

Switch disconnector is a short circuit switch without protection function and as the appearance is equivalent to the circuit breaker, all accessories can be shared with the circuit breaker.

### Common Ratings

Rated Insulation Voltage, Ui	1,000 V	Suitability for Isolation	Yes
Rated Operational Voltage, Ue	690 V	Utilization Category	AC 22 A/AC 23 A - DC 22 A/DC 23 A
Rated Impulse Withstand Voltage, Uimp	8 kV	Pollution Degree	3
		Reference Standard	IEC 60947-3

Model Name		HGP50DNA	HGP125DNA	HGP160DNA		
Frame	(AF)	50	125	160		
Number of Poles	(P)	3, 4 <sup>1)</sup>	3, 4 <sup>1)</sup>	3, 4 <sup>1)</sup>		
Conventional Thermal Current, Ith at 60 °C	(A)	50	125	160		
<b>Rated Operational Current [Ie]</b>						
AC 690V (50/60 Hz)		50	125	160		
DC 250 V (1 Pole)		50	125	160		
DC 250 V (2 Pole in Series)		50	125	160		
Rated Short-Circuit Making Capacity [Icm] (kA Peak)		2.1	2.8	3.6		
<b>Rated Short-Time Withstand Current [Icw]</b>						
1 s	(A rms)	1,800	2,200	2,200		
3 s	(A rms)	1,800	2,200	2,200		
20 s	(A rms)	690	960	960		
<b>Endurance [times] (Durability)</b>						
Mechanical		25,000	25,000	25,000		
In @ 440 V		10,000	10,000	10,000		
<b>Accessory</b>						
Internal	Auxiliary Switch	AUX	●	●	●	
	Alarm Switch	ALT	●	●	●	
	Shunt Trip	SHT	●	●	●	
	Under-Voltage Trip	UVT	●	●	●	
External	Rotary Handle	Front Contact	TFG	●	●	●
		Extension	TFH	●	●	●
	Mechanical Open/Close Device	MOT	●	●	●	
	Mechanical Interlock	MIF	●	●	●	
	Handle Locking Device	PLD	●	●	●	
	Plug-in	TDM (LINE/LOAD)	● (3P Only)	● (3P Only)	● (3P Only)	
		TDM (LINE Only)	● (3P Only)	● (3P Only)	● (3P Only)	
	Cage Terminal Block	CTB	●	●	●	
	Terminal Cover	TCF	●	●	●	
	Insulation Barrier	TQQ	●	●	●	
Terminal Bus Bar	TBB	-	-	-		
<b>Installation and Dimensions</b>						
Connection/ Installation	Front Connection	Terminal Screw				
	Rear Connection	Horizontal/Vertical Cable				
	Plug-in	Switchgear (Line & Load, Line Only)				
Dimension (mm)	a (3/4P)	90/120	90/120	90/120		
	b	140	140	140		
	c	86	86	86		
Weight (kg)	3/4P	1.5/1.8	1.5/1.8	1.5/1.8		
Detailed Rating and Selection		234 Page	234 Page	234 Page		
Characteristic Curve and Appearance		176 Page	176 Page	176 Page		

※ 1) 4 Pole Arrangement : Basic specification of R-S-T-N

### Applicable Field of Switch – Disconnectors

- Bus bar connection and disconnection
- Disconnection of switchgear and control panel
- Switch for emergency power switchover (ATS)

HGP250NA	HGP400NA	HGP630NA	HGP800NA
250	400	630	800
3, 4 <sup>1)</sup>	3, 4 <sup>1)</sup>	3, 4 <sup>1)</sup>	3, 4 <sup>1)</sup>
250	400	630	800
250	400	630	800
250	400	630	800
250	400	630	800
4.9	7.1	8.5	12
3,500	5,000	6,300	8,000
3,500	5,000	6,300	8,000
1,350	1,920	2,320	2,560
25,000	20,000	20,000	10,000
10,000	6,000	4,000	3,000
●	●	●	●
●	●	●	●
●	●	●	●
●	●	●	●
●	●	●	●
●	●	●	●
●	●	●	●
●	●	●	●
●	●	●	●
● (3P Only)	● (3P Only)	● (3P Only)	● (3P Only)
● (3P Only)	● (3P Only)	● (3P Only)	● (3P Only)
●	●	●	●
●	●	●	●
●	●	●	●
●	●	●	●
Terminal Screw	Terminal Screw	Terminal Screw	Terminal Screw
Horizontal/Vertical Cable	Horizontal/Vertical Cable	Horizontal/Vertical Cable	Horizontal/Vertical Cable
Switchgear (Line & Load, Line Only)	Switchgear (Line & Load, Line Only)	Switchgear (Line & Load, Line Only)	Switchgear (Line & Load, Line Only)
105/140	140/186.5	140/186.5	210/280
165	260	260	320
86.5	110	110	135
2/2.6	5.4/7.2	5.4/7.2	15.1/19.6
234 Page	234 Page	234 Page	234 Page
177 Page	178 Page	178 Page	179 Page

# Model Selection Table

## Molded Case Circuit Breaker (HGP DC Type)

### Common Ratings

Rated Insulation Voltage, Ui	1,000 V	Suitability for Isolation	Yes
Rated Impulse Withstand Voltage, Uimp	8 kV	Utilization Category	A
Protection Function	Overload, Instantaneous, Short-Circuit Protection	Pollution Degree	3
		Reference Standard	IEC 60947-2

Model Name		HGP100				HGP160			
Frame	(AF)	100				160			
Number of Poles	(P)	3, 4 <sup>1)</sup>				3, 4 <sup>1)</sup>			
Rated Current, at 40 °C	(A)	40, 50, 63, 80, 100				100, 125, 150, 160			
<b>Rated Ultimate Short-Circuit Breaking Capacity [Icu] (kA rms)</b>									
Short-Circuit Breaking Category Code		F	S	H	X	F	S	H	X
DC 750 V for 3P		10	55	85	100	10	55	85	100
DC 1,000 V for 4P		10	55	85	100	10	55	85	100
Service Breaking Capacity [Ics = % Icu]		100	100	100	100	100	100	100	100
<b>Trip Device</b>									
Thermal Magnetic	Long Time [LTD]	(0.7 - 0.8 - 0.9 - 1.0) × In				(0.7 - 0.8 - 0.9 - 1.0) × In			
	Instantaneous [INST]	10 × In				(5 - 6 - 7 - 8 - 9 - 10) × In			
<b>Accessory</b>									
Internal	Auxiliary Switch	AUX	●			●			
	Alarm Switch	ALT	●			●			
	Shunt Trip	SHT	●			●			
	Under-Voltage Trip	UVT	●			●			
External	Rotary Handle	Front Contact	TFG	●		●			
		Extension	TFH	●		●			
	Mechanical Open/Close Device	MOT	●			●			
	Mechanical Interlock	MIF	●			●			
	Handle Locking Device	PLD	●			●			
	Cage Terminal Block	CTB	●			●			
	Insulation Barrier	TQQ	●			●			
	Terminal Bus Bar	TBB	●			●			
Series Busbar	SBB	●			●				
<b>Installation and Dimensions</b>									
Connection/Installation	Front Connection	Terminal Screw, Terminal Bus Bar			Terminal Screw, Terminal Bus Bar				
Dimension (mm)	a (3/4P)	105/140			105/140				
	b	165			165				
	c	86.5			86.5				
Weight (kg)	3/4P	2/2.6			2/2.6				
Detailed rating and Selection		234			234				
Characteristic Curve and Appearance		157 / 229			157 / 229				
Certification	CB-DEKRA	●			●				

※ 1) 4 Pole Arrangement : Basic specification of R-S-T-N

HGP250				HGP400				HGP630				HGP800			
250				400				630				800			
3, 4 <sup>1)</sup>				3, 4 <sup>1)</sup>				3, 4 <sup>1)</sup>				3, 4 <sup>1)</sup>			
125, 150, 160, 175, 200, 225, 250				300, 350, 400				500, 630				700, 800			
F	S	H	X	F	S	H	X	F	S	H	X	F	S	H	X
10	55	85	100	10	55	85	100	10	55	85	100	10	55	85	100
10	55	85	100	10	55	85	100	10	55	85	100	10	55	85	100
100	100	100	100	100	100	100	100	100	100	100	100	100	100	100	100
(0.7 - 0.8 - 0.9 - 1.0) × In				(0.8 - 0.9 - 1.0) × In				(0.8 - 0.9 - 1.0) × In				(0.8 - 0.9 - 1.0) × In			
(5 - 6 - 7 - 8 - 9 - 10) × In				(5 - 6 - 7 - 8 - 9 - 10) × In				(5 - 6 - 7 - 8 - 9 - 10) × In				(5 - 6 - 7 - 8 - 9 - 10) × In			
●				●				●				●			
●				●				●				●			
●				●				●				●			
●				●				●				●			
●				●				●				●			
●				●				●				●			
●				●				●				●			
●				●				●				●			
●				●				●				●			
●				●				●				●			
●				●				●				●			
●				●				●				●			
●				●				●				●			
●				●				●				●			
●				●				●				●			
●				●				●				●			
●				●				●				●			
●				●				●				●			
●				●				●				●			
Terminal Screw, Terminal Bus Bar	Terminal Screw, Terminal Bus Bar			Terminal Screw, Terminal Bus Bar			Terminal Screw, Terminal Bus Bar			Terminal Screw, Terminal Bus Bar					
105/140	140/186.5			140/186.5			210/280								
165	260			260			320								
86.5	110			110			135								
2/2.6	5.4/7.2			5.4/7.2			15.1/19.6								
234	234			234			234								
157 / 229	158 / 229			158 / 229			158 / 230								
●	●			●			●								

## Technical Data (HGP DC Type)

### Installation

#### Precautions for Use

Please keep in mind the following installation conditions when applying the product to a solar power system. Otherwise, it could lead to damage to the product and the system.

### Circuit Diagram

Referring to the contact circuit diagram below, connect the adjacent poles in series.

In the case where a 3P product is used for a 2P product, connect it skipping the phase(s) in the middle.

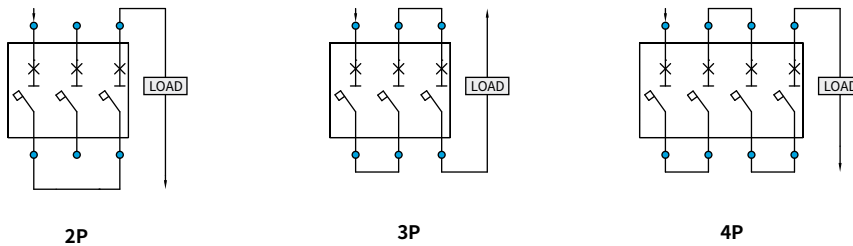

### Connection

In wiring the circuit, a wire must be at least as long as 60 cm.

If it is shorter than that, it can produce excessive heat.

When using the busbar, operate it referring to the Rated Current Derating Table on the right.

When using a self-produced busbar, please keep it to the dimension on page 229 ~ 230. And it is recommended to plate it (busbar) with silver or tin. (A busbar and a heat sink are optional. You need to make an additional order if you want it.)(SBB 25/63/80 GP)

### Insulation

Please insert a barrier between the phases after connecting a busbar or a cable if they do not use the same phase.

### External Environment

In the case that the internal temperature of the panel is above 40 °C, derate the temperature, referring to the Rated Current Derating Table on the right.

## Technical Data

### Environmental Operating Conditions

#### Temperature Derating

The overcurrent characteristic of MCCB has been set to the ambient temperature of 40 °C. If the ambient temperature is less or more than 40 °C, the overcurrent characteristics may differ.

#### If the Ambient Temperature is less than 40 °C

In order to ensure that the circuit breaker’s overcurrent meet the derating curve at the given ambient temperature, the real current (Ir) has to be adjusted. The temperature correction ratio or each MCCB is shown in the circuit breaker’s characteristics curve.

#### If the Ambient Temperature is more than 40 °C

As the internal temperature of MCCB is a sum of increased temperature due to current flow and the ambient temperature, if the ambient temperature exceeds 40 °C, thermal damage of internal insulation material of MCCB may occur causing the circuit breaker to trip at an early stage. When applying ambient temperature higher than 40 °C, the rated current must be adjusted as shown in the following rated current correction table.

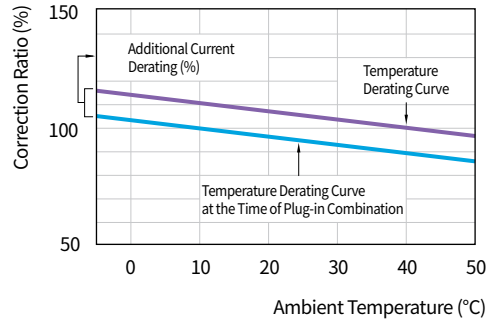

$I_n$  (Rated Current) :  
Circuit breaker’s rating at ambient temperature of 40 °C  
 $I_r$  (Real Current) :  
Circuit breaker’s rating at the given temperature  
 $I_r = \text{Correction Ratio (\%)} \times I_n$

**Rated Current Derating Table : HGP DC Type/Standard Mounting (Fixed Type)**

Model	Rated Current (Adc)	Ambient Temperature (°C)										Connection
		10	20	30	40	45	50	55	60	65	70	
HGP100 HGP160 HGP250	40	46	44	42	40	39	38	37	36	35	34	HGP250 Busbar
	50	58	55	53	50	49	48	46	45	44	43	
	63	72	69	66	63	61	60	58	57	55	54	
	80	92	88	84	80	78	76	74	72	70	68	
	100	115	110	105	100	98	95	93	90	88	85	
	125	144	138	131	125	122	119	116	113	109	106	
	150	173	165	158	150	146	143	139	135	131	128	
	160	184	176	168	160	156	152	148	144	140	136	
	175	201	193	184	175	171	166	162	158	153	149	
	200	230	220	210	200	195	190	185	180	175	170	
HGP400 HGP630	225	259	248	236	225	219	214	208	203	197	191	HGP250 Busbar + Heat Sink
	250	288	275	263	250	244	238	231	225	219	213	
	300	323	315	308	300	291	282	273	264	255	246	
	350	376	368	359	350	340	330	320	310	300	290	
	400	430	420	410	400	388	376	364	352	340	328	
HGP800	500	538	525	513	500	485	470	455	440	425	410	HGP630 Busbar + Heat Sink
	630	677	662	646	630	611	592	573	554	535	516	
	700	753	735	718	700	679	658	637	616	595	574	
HGP800	800	860	840	820	800	776	752	728	704	680	656	HGP800 Busbar + Heat Sink

## Accessory

### HGM General-Type

Accessories

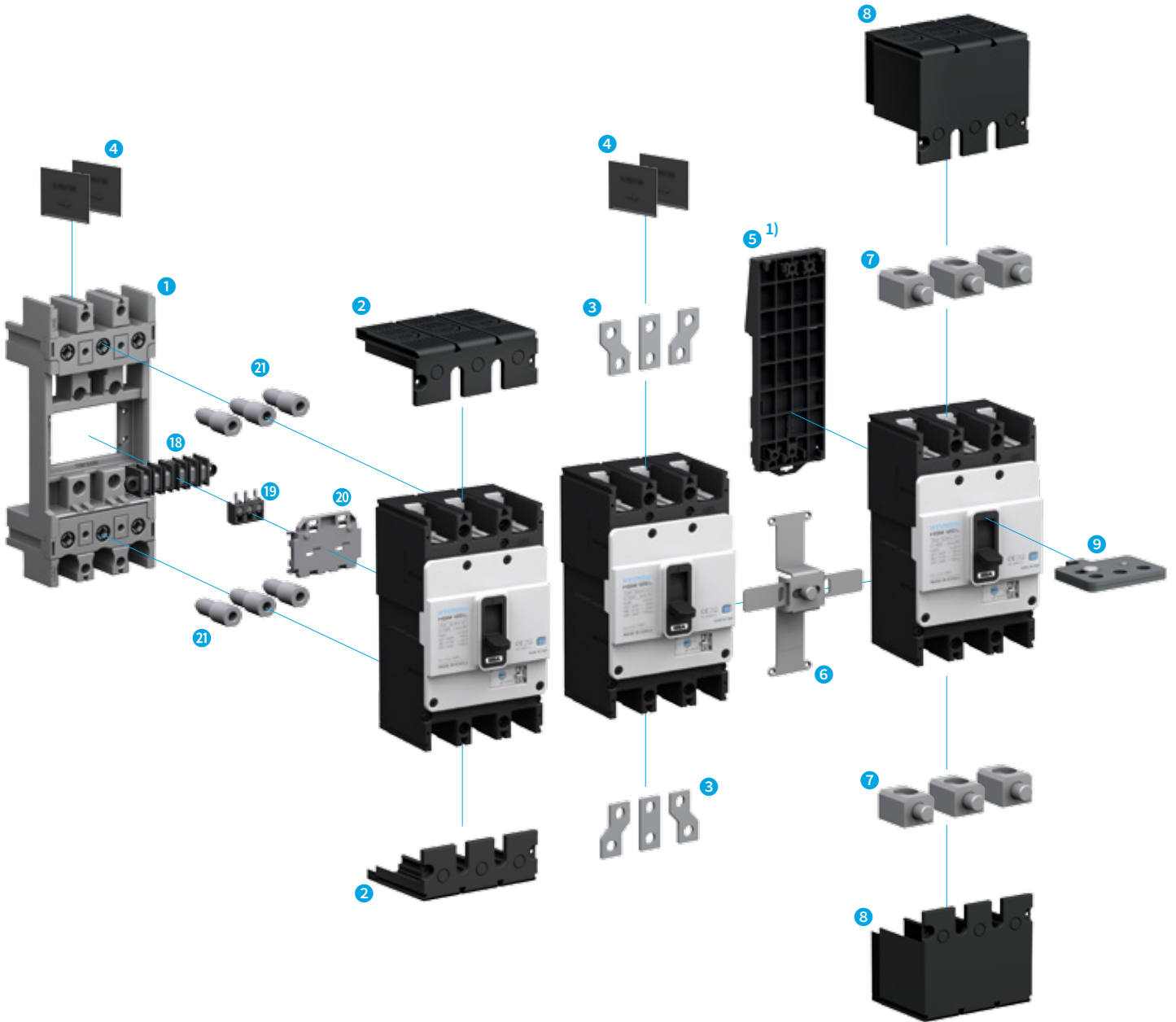

※ 1) DIN Rail Adaptor (DRA) : For HGM/HGE100



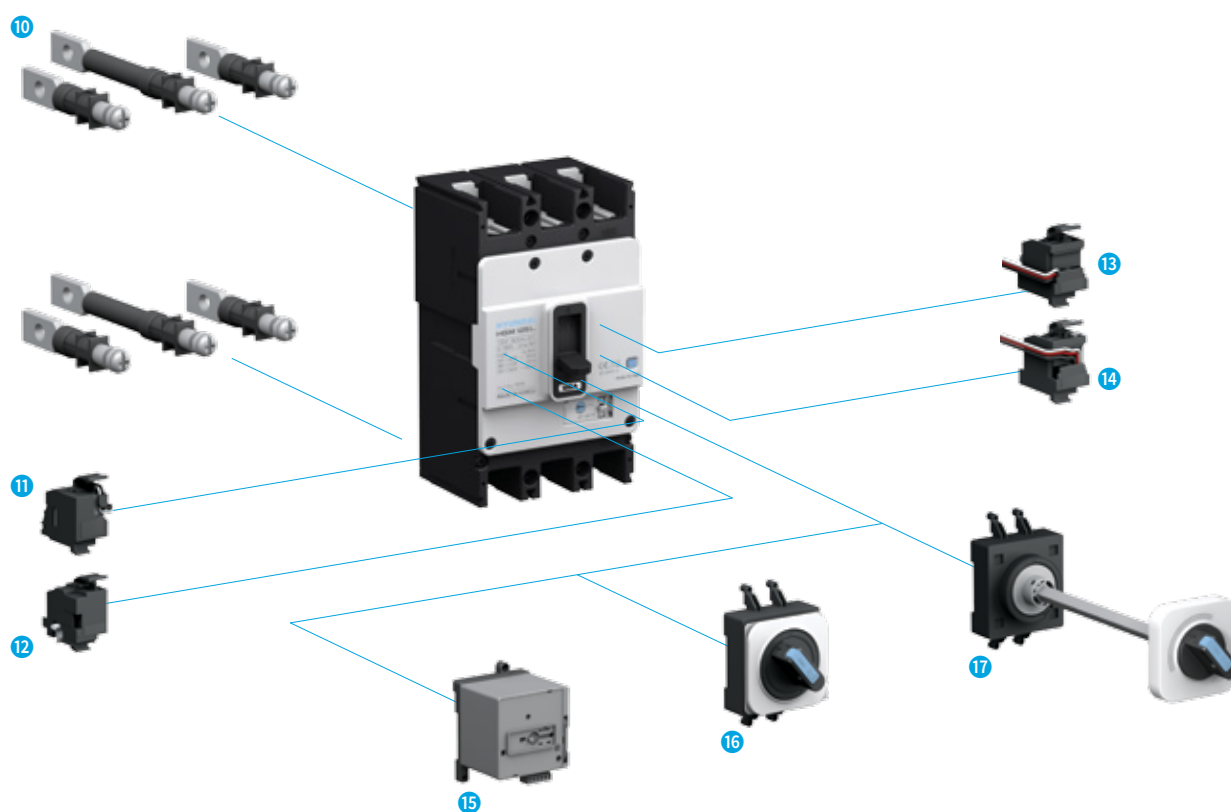

### HGM Type MCCB

- |                                      |                                       |  |
|--------------------------------------|---------------------------------------|--|
| 1 Plug-in Device (TDA, TDM, TDF)     | 8 Terminal Cover (General-Type) (TCF) | 15 Motor Operator (MOT)                    |
| 2 Terminal Cover (For Plug-in) (TCF) | 9 Padlock (PLD)                       | 16 Front Contact Rotary Handle (TFG)       |
| 3 Bus Bar (TBB)                      | 10 Rear Connection Terminal (RCT)     | 17 Extension Rotary Handle (TFH)           |
| 4 Insulation Barrier (TQQ)           | 11 Shunt Trip Switch (SHT)            | 18 Plug-in Terminal Block (CBM)            |
| 5 DIN Rail Adaptor (DRA)             | 12 Under-Voltage Trip Switch (UVT)    | 19 Plug-in Terminal Block (CBB BLOCK UNIT) |
| 6 Mechanical Interlock (MIF)         | 13 Auxiliary Switch (AUX)             | 20 Plug-in Terminal Block (CBB PLATE)      |
| 7 Lug Terminal (CTB)                 | 14 Trip Alarm Switch (ALT)            | 21 Plug-in Terminal (PC MALE)              |

## Accessory

### HGP High Breaking Capacity

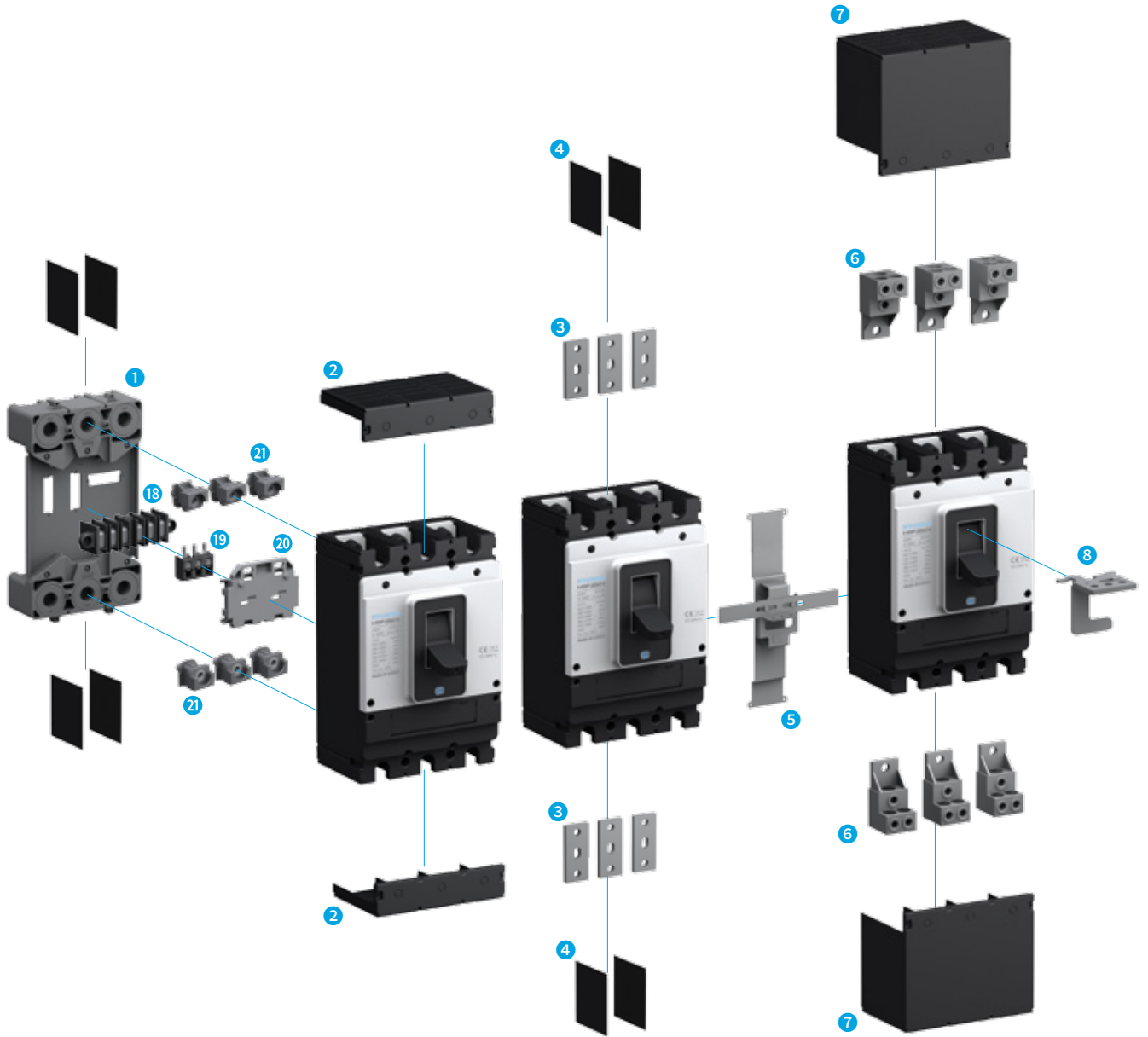

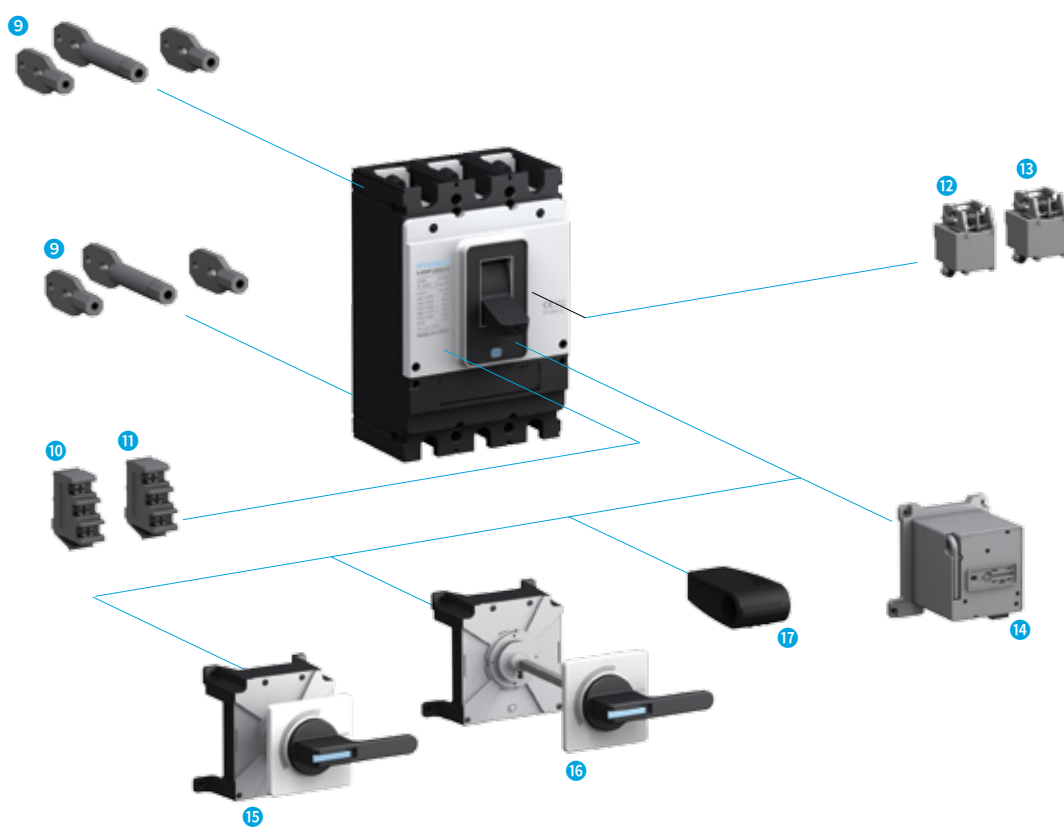

### HGP Type MCCB

- |   |                                    |  |
|---|------------------------------------|--|
| 1 Plug-In Device (TDM)                          | 8 Padlock (PLD)                    | 15 Front Contact Rotary Handle (TFG)       |
| 2 Terminal Cover (For Plug-in) (TCF Short Type) | 9 Rear Connection Terminal (RCT)   | 16 Extension Rotary Handle (TFH)           |
| 3 Bus Bar (TBB)                                 | 10 Auxiliary Switch (AUX)          | 17 Auxiliary Handle (THA)                  |
| 4 Insulation Barrier (TQQ)                      | 11 Trip alarm Switch (ALT)         | 18 Plug-in Terminal Block (CBM)            |
| 5 Mechanical Interlock MIF)                     | 12 Shunt trip Switch (SHT)         | 19 Plug-in Terminal Block (CBB BLOCK UNIT) |
| 6 Lug Terminal (CTB)                            | 13 Under-Voltage Trip Switch (UVT) | 20 Plug-in Terminal Block (CBB PLATE)      |
| 7 Terminal Cover (General-Type) (TCF Long Type) | 14 Motor Operator (MOT)            | 21 Plug-in Terminal (PC MALE)              |

## Internal Accessories (HGM)



AUX, ALT, AXT, SHT, UVT



AUX, ALT, AXT

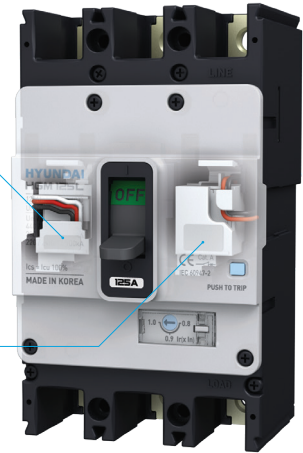

HGM30, 50E/S, 60, 100

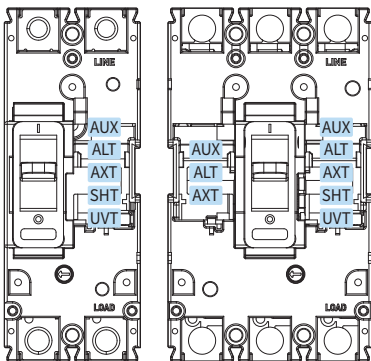

HGM50H/L, 125

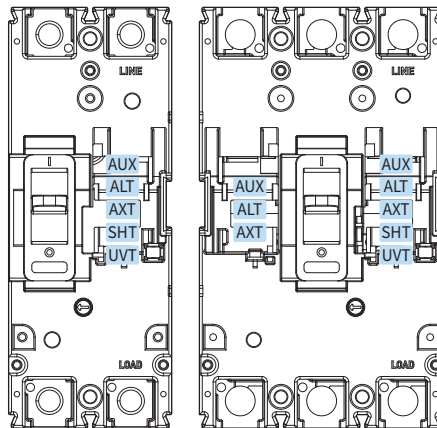

HGM160, 250

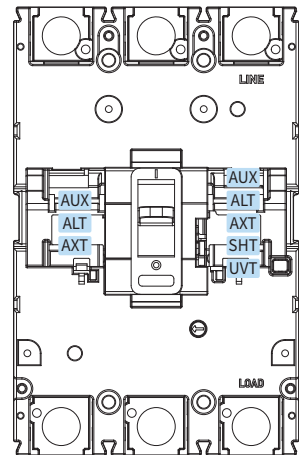

### Possible Installation Combinations (Below 250 AF)

Type	Pole	AUX	ALT	SHT	UVT	AXT	AUX	AUX	SHT	UVT	SHT	UVT	SHT	UVT
							ALT	ALT	AUX	AUX	ALT	ALT	AXT	AXT
HGM30 ~ HGM125	2													
HGM30 ~ HGM250	3/4													
HGE30 ~ HGE250	2/3/4													

※ AUX : Auxiliary Switch □ / ALT : Alarm Switch ■ / SHT : Shunt Trip ▨ / UVT : Under-Voltage Trip ▩ / AXT : Auxiliary Alarm Switch ◼ (AUX/ALT Integrated Type)

## HGM Type's Internal Accessories and Possible Location for Installation

- Auxiliary Switch (AUX)
- Alarm Switch (ALT)
- Auxiliary + Trip Alarm Switch (AXT)
- Shunt Trip Coil (SHT)
- Under-Voltage Trip Coil (UVT)

HGM400

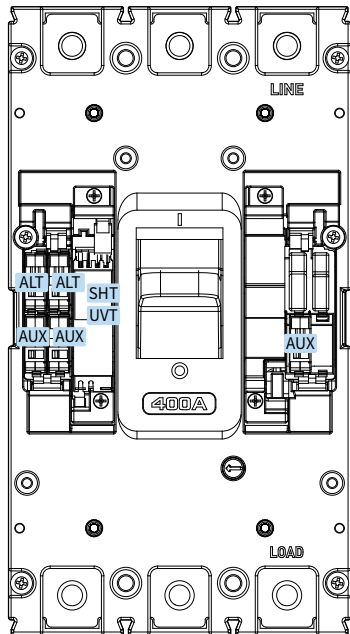

HGM630, 800

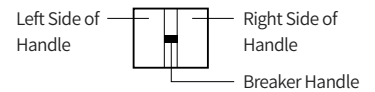
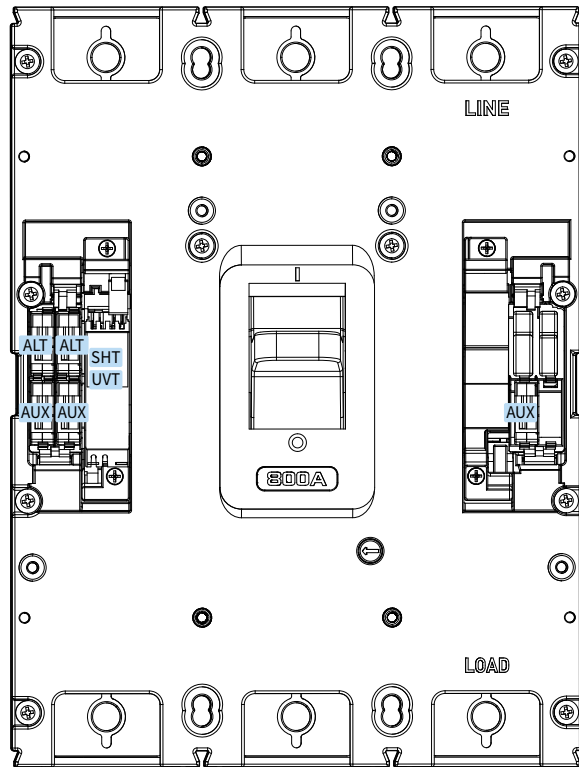

Possible Installation Combinations (400 ~ 800 AF)

Type	Pole	AUX	ALT	SHT	UVT	AUX	SHT	UVT	SHT	UVT	SHT	UVT
						ALT	AUX	AUX	ALT	ALT	AUX	AUX
HGM400	2/3/4											
HGM630 HGM800	2/3 4RSTN											
HGM630 HGM800	4NRST											
HGE400	2/3/4											
HGE630 HGE800	2/3											

※ AUX : Auxiliary Switch □ / ALT : Alarm Switch ■ / SHT : Shunt Trip ▣ / UVT : Under-Voltage Trip ☒  
HGM Type's ZCT embedded type of product can be combined equally as HGE Type.

## Internal Accessories (HGM)

### Auxiliary Switch (AUX) / Trip Alarm Switch (ALT)

It is a contact for indicating the status of the circuit breaker in a remote position.

This contact can be used to realize not only the indication function but also electrical functions such as electrical lock and relay.

#### Auxiliary Switch (AUX)

- Indicates the ON/OFF status of the circuit breaker contact.
- Status is OFF during TRIP.
- It is comprised of C contact.

#### Trip Alarm Switch (ALT)

- It is only activated when the circuit breaker has tripped due to an overload, short circuit or operation of shunt trip switch and does not operate during general ON/OFF.
- Returns to original state when circuit breaker has been reset.
- It is comprised of C contact.

#### Auxiliary + Trip Alarm Switch (AXT)

- This switch is an integrated combination of auxiliary switch and trip alarm switch.

#### Contact Circuit Diagram

	Auxiliary Switch (AUX)	Trip Alarm Switch (ALT)
MCCB ON		
MCCB OFF		
MCCB TRIP		

#### Possible Location for Installation

Type	Pole	AUX	ALT	AXT
HGM30 ~ HGM125	2			
HGM30 ~ HGM250	3/4			
HGE30 ~ HGE250	2/3/4			
HGM400	2/3/4			
HGE400	2/3/4			
HGM630 HGM800	2/3/4			
HGE630 HGE800	2/3			

#### Rating of Contact

Rated Conventional Thermal Current	5 A		
Minimum Load	160 mA, 5 VDC		
Rated Operation Current	Resistive Load	Inductive Load	
	AC 125 V	5 A	3 A
	AC 250 V	3 A	2 A
	DC 30 V	4 A	3 A
	DC 125 V	0.4 A	0.4 A
	DC 250 V	0.2 A	0.2 A

※ AUX : Auxiliary Switch   
 ALT : Alarm Switch   
 AXT : Auxiliary Alarm Switch   (AUX/ALT Integrated Type)



## Shunt Trip Device (SHT)

Shunt trip device (SHT) is a device that remotely trips the circuit breaker by applying voltage to both terminals of the coil.

### Operating Condition

- $U \geq 0.7 \times U_n$  (More than 70 % of rated voltage applied)
- As for impulse type voltage, more than 20 ms applied

### Rated Voltage and Characteristics (100 ~ 250 AF)

Rated voltage (Un)	Power Consumption	
	VA (W)	A (A)
DC	24 V	50.2
	48 V	94.6
	60 V	91.2
	100 ~ 120 V	11.8
	125 V	58.1
AC (50/60 Hz)	100 ~ 120 V	75.2
	200 ~ 250 V	64.8
	380 ~ 480 V	131
Rated Operational Voltage	0.7 ~ 1.1 × Un	
Operating Time	50 ms	

※ Controller output voltage : DC 45 V

### SHT Wiring

#### 1. SHT Only



※ Not applicable to  
HGM400, 630, 800 AF DC 24 V

#### 2. HGM400, 630, 800 AF DC 24 V (SHT + Controller)

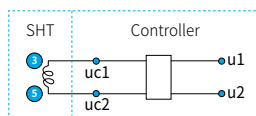

### Possible Location for Installation

Type	Pole	SHT	UVT
HGM30 ~ HGM125	2		
HGM30 ~ HGM250	3/4		
HGE30 ~ HGE250	2/3/4		
HGM400	2/3/4		
HGE400	2/3/4		
HGM630 HGM800	2/3/4		
HGE630 HGE800	2/3		

※ SHT : Shunt Trip   
UVT : Under-Voltage Trip



SHT

## Internal Accessories (HGM)

### Under-Voltage Trip Device (UVT)

In case the circuit voltage drops to less than 35 % of the rated voltage ( $U_n$ ), UVT automatically initiates a trip in the circuit breaker to prevent damage to the load.

#### Opening Conditions

- Operating characteristics are guaranteed to conform to the IEC 60947-2 standard criteria.
- Trip Condition of Circuit Breaker :  $U \leq 0.35 \times U_n$
- Fixed Type : 50 ms (400 ~ 800 AF)
- Time Delay Type : 500 ~ 1,000 ms (Below 250 AF)
- No Trip Condition of Circuit Breaker :  $U \geq 0.7 \times U_n$
- In the  $U = 0.35 \sim 0.7 \times U_n$  interval, the circuit breaker can be tripped but the operation is not guaranteed.

#### Time Delay Function

Malfunction is prevented during a short momentary voltage drop of below 500 ms. (Below 250 AF)

#### UVT Wiring

1. HGM30 ~ 250 AF (UVT + Controller)

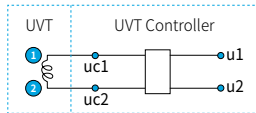

※ DC 24 V among HGM400 and above products require a controller.

2. HGM400, 630, 800 AF (UVT Only)



#### Closing Conditions

- In case of circuit breakers assembled with UVT, the circuit breaker cannot be ON (Closing) when voltage is not applied to the UVT.
- The reset operation after the circuit breaker's trip caused by UVT operation may differ depending on the circuit breaker's type and UVT structure.
- In order to close the circuit breaker, Voltage must be applied to UVT.
- Closing Condition :  $U \geq 0.85 \times U_n$

#### Rated Voltage and Characteristics (Below 250 AF)

Rated Voltage ( $U_n$ )	Power Consumption		
	VA (W)	A (mA)	
DC	24 V	0.96	40
	48 V	1.1	22.7
	100 ~ 110 V	2.2	20
AC (50/60 Hz)	100 ~ 120 V	5.1	42
	200 ~ 230 V	6	26
	380 ~ 415 V	9.6	23
	440 ~ 480 V	12.5	26
Starting Voltage	Opening	0.35 ~ 0.7 $\times$ $U_n$	
	Closing	0.85 $\times$ $U_n$	
Rated Operational Voltage	0.85 ~ 1.1 $\times$ $U_n$		
Operating Time	500 ~ 1,000 ms		

※ Do not use UVT for electrical interlocking system.

※ Controller output voltage : DC 45 V



UVT



UVT Controller



# Internal Accessories (HGP)

## HGP Type's Internal Accessories and Possible Location for Installation

- Auxiliary Switch (AUX)
- Alarm Switch (ALT)
- Shunt Trip Coil (SHT)
- Under-Voltage Trip Coil (UVT)
- Fault Alarm Contact (FAL), Only for Electronic

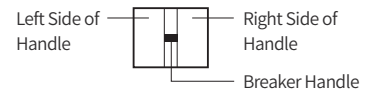
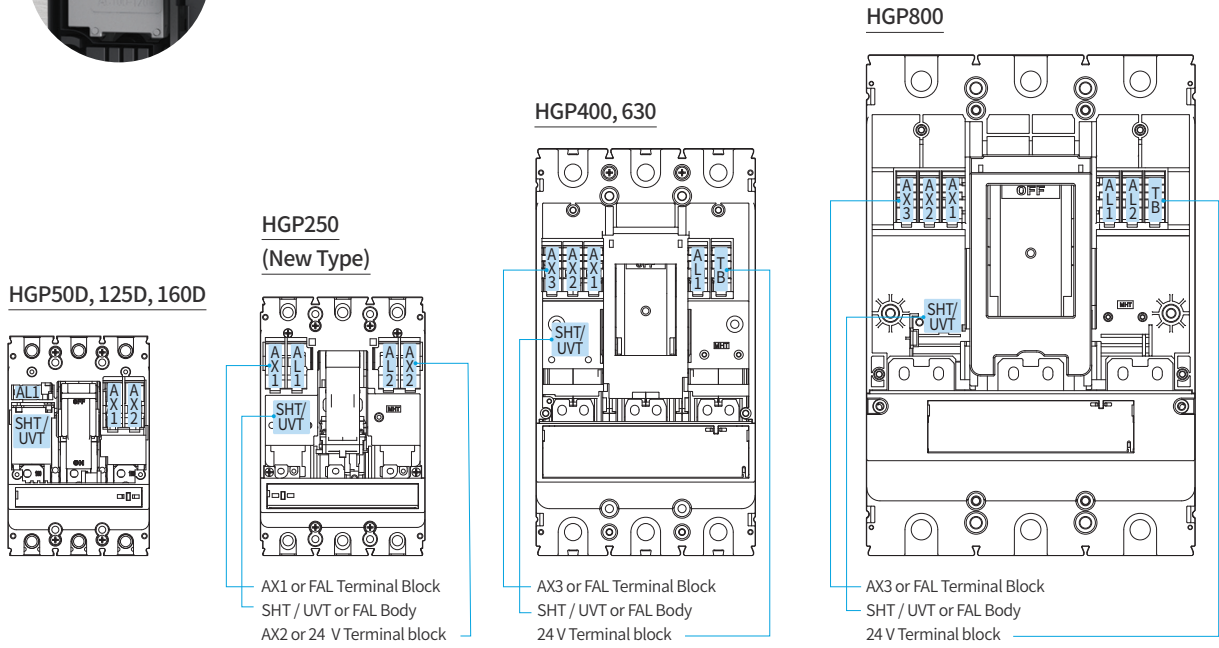
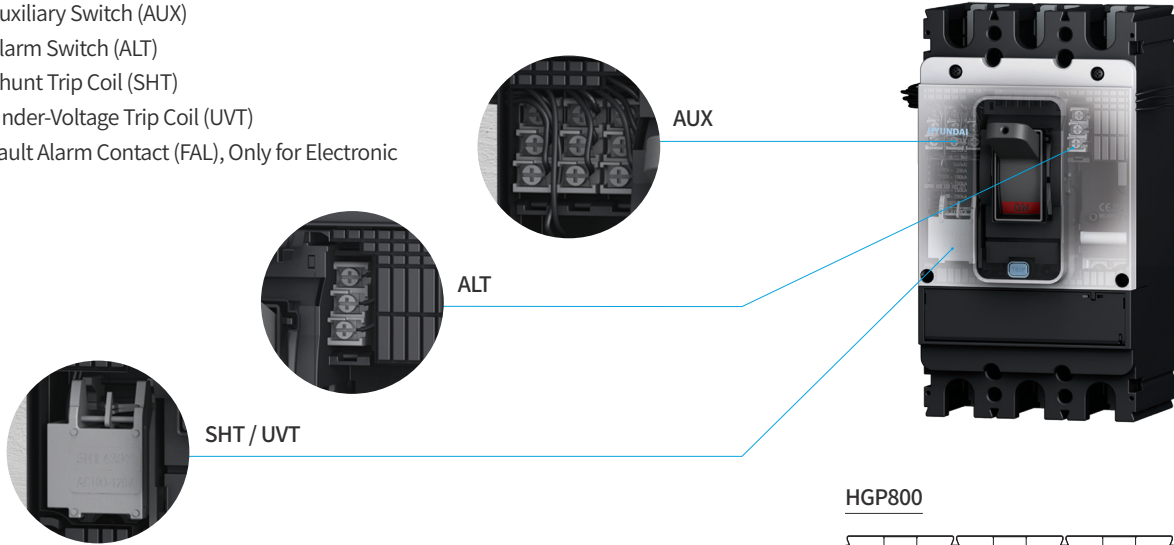

### Possible Location for Installation

Type	Pole	SHT		UVT		SHT		UVT		SHT		UVT	
		AUX	ALT	AUX	ALT	AUX	ALT	AUX	ALT	AUX	ALT	AUX	ALT
HGP50D HGP125D HGP160D	3/4	□	■	□	■	□	■	□	■	□	■	□	■
HGP250	3/4	□	■	□	■	□	■	□	■	□	■	□	■
HGP400 HGP630	3/4	□	■	□	■	□	■	□	■	□	■	□	■
HGP800	3/4	□	■	□	■	□	■	□	■	□	■	□	■

※ AUX : Auxiliary Switch □ / ALT : Alarm Switch ■ / SHT : Shunt Trip □ / UVT : Under-Voltage Trip □ / AXT : Auxiliary Alarm Switch □ (AUX/ALT Integrated Type)

## Internal Accessories (HGP)

### Auxiliary Switch (AUX)/ Trip Alarm Switch (ALT)

It is a contact for indication to inform the status of the circuit breaker in a remote position.

This contact can be used to realize not only the indication function but also electrical functions such as electrical lock and relay.

#### Auxiliary Switch (AUX)

- Indicates the ON/OFF status of the circuit breaker contact.
- Status is OFF during TRIP.
- It is comprised of C contact.







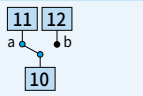
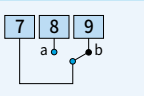
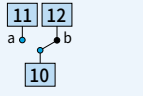
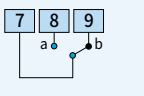
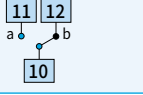
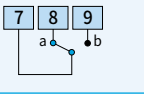

#### Trip Alarm Switch (ALT)

- It is only activated when the circuit breaker has tripped due to an overload, short circuit or operation of shunt trip switch and does not operate during general ON/OFF.
- Returns to original state when circuit breaker has been reset.
- It is comprised of C contact.

#### Contact Circuit Diagram

	Auxiliary Switch (AUX)	Trip Alarm Switch (ALT)
MCCB ON		
MCCB OFF		
MCCB TRIP		

#### Possible Location for Installation

Type	AUX	ALT
HGP50D HGP125D HGP160D		
HGP250		
HGP400 HGP630		
HGP800		

#### Rating of Contact

Rated Conventional Thermal Current	5 A		
Minimum Load	160 mA, 5 VDC		
Rated Operation Current	Resistive Load	Inductive Load	
AC	125 V	5 A	3 A
	250 V	3 A	2 A
DC	30 V	4 A	3 A
	125 V	0.4 A	0.4 A
	250 V	0.2 A	0.2 A



HGP160D ALT



HGP250 ~ 800 ALT  
HGP160D ~ 800 AUX

## Shunt Trip Device (SHT) / Under-Voltage Device (UVT)

SHT/UVT is installed inside the circuit breaker and it offers the function of remote tripping the circuit breaker by controlling the voltage applied to both terminals of the coil.

### Shunt Trip Device (SHT)

It is able to remotely trip the circuit breaker by applying voltage to the shunt trip device installed in the circuit breaker.

#### Operating Condition

- $U \geq 0.7 \times U_n$  (More than 70 % of rated voltage applied)
- As for impulse type voltage, more than 20 ms applied

#### Rated Voltage and Characteristics

Rated Voltage (Un)	Power Consumption	
	W or VA	A (mA)
DC	24 V	1.2
	100 ~ 110 V	2.8
	100 ~ 120 V	3.3
AC (50/60 Hz)	200 ~ 230 V	5.2
	380 ~ 415 V	13.9
	440 ~ 480 V	10.9
	22.8	
Rated Operational Voltage	0.7 ~ 1.1 × Un	
Operating Time	50 ms	

※ Controller output voltage : DC 45 V

#### Possible Location for Installation

Type	SHT	UVT
HGP50D HGP125D HGP160D		
HGP250		
HGP400 HGP630		
HGP800		

#### SHT Wiring

1. SHT Only



2. HGP160D DC SHT

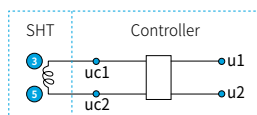

※ 160D AF (50D, 125D, 160D) DC products include controller.

#### UVT Wiring

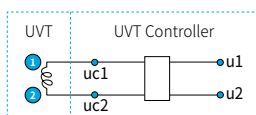

### Under-Voltage Device (UVT)

If the under-voltage trip device is installed in the circuit breaker, the circuit breaker is tripped or is not closed in case the circuit voltage is below the reference value.

In case the circuit voltage drops to less than 35 % of the rated voltage (Un), UVT automatically initiates a trip in the circuit breaker to prevent damage to the load.

#### Opening Conditions

- Operating characteristics are guaranteed to conform to the IEC 60947-2 standard criteria.
- Trip Condition of Circuit Breaker :  $U \leq 0.35 \times U_n$
- No Trip Condition of Circuit Breaker :  $U \geq 0.7 \times U_n$
- In the  $U = 0.35 \sim 0.7 \times U_n$  interval, the circuit breaker can be tripped but the operation is not guaranteed.

#### Closing Conditions

- In case of circuit breakers assembled with UVT, the circuit breaker can be OFF/RESET when voltage is not applied but the circuit breaker cannot be ON (Closing).
- In order to close the circuit breaker, Voltage must be applied to UVT.
- Closing Condition :  $U \geq 0.85 \times U_n$

#### Rated Voltage and Characteristics

Rated Voltage (Un)	Power Consumption	
	W or VA	A (mA)
DC	24 V	2.6
	100 ~ 110 V	5
	100 ~ 120 V	4.5
AC (50/60 Hz)	200 ~ 230 V	5.6
	380 ~ 415 V	10.8
	440 ~ 480 V	12.5
	26	
Starting Voltage	Opening	0.35 ~ 0.7 × Un
	Closing	0.85 × Un
Rated Operational Voltage	0.85 ~ 1.1 × Un	
Operating Time	50 ms	

※ Do not use UVT for electrical interlocking system.

※ Controller output voltage : DC 45 V



## External Accessories (HGM)

### Locking Device

#### Handle Locking Device Using Padlock (PLD)

This device is used for locking the handle of circuit breaker to the OFF position by using a padlock. Padlock is not provided separately and up to 3 can be used. The applicable specifications of padlocks are as below.

Type	Application	Padlock Diameter <sup>1)</sup>
PLD 10GM	HGM30 ~ HGM250	5 mm
	HGE30 ~ HGE250	
PLD 40GM	HGM400 ~ HGM800	6 mm
	HGE400 ~ HGE800	

#### Mechanical Interlock

This device interlocks two circuit breakers by using a mechanical interlock.

#### Key Features

- It prevents two breakers from closing at the same time.
- All circuit breakers are turned OFF. The applicable specifications of padlocks are as below.

Type				Application	Padlock Diameter <sup>1)</sup>
2P	3P	4P (RSTN)	4P (NRST)		
MIF 10GM 2	MIF 10GM 3	MIF 10GM R4	MIF 10GM N4	HGM/HGE30, 50E/S, 60, 100	5 mm
MIF 12GM 2	MIF 12GM 3	MIF 12GM R4	MIF 12GM N4	HGM/HGE50H/L,125	
-	MIF 25GM 3	MIF 25GM R4	MIF 25GM N4	HGM/HGE160, 250	
-	MIF 40GM 3	MIF 40GM R4	MIF 40GM N4	HGM/HGE400	6 mm
-	MIF 80GM 3	MIF 80GM R4	MIF 80GM N4	HGM/HGE630, 800	



PLD

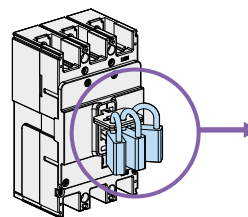
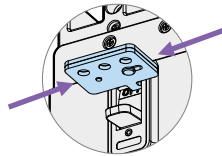

Padlock Diameter  
(Refer to Table)



MIF

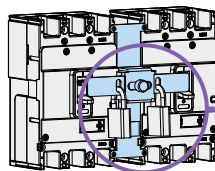

Padlock Diameter  
(Refer to Table)

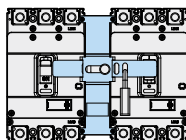

Right Off Lock

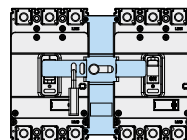

Left Off Lock

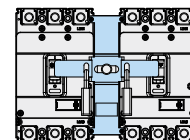

Double Off Lock

※ 1) Padlock not included

## Terminal Cover

As a part that insulates the circuit breaker's live and load side of terminal area from the outside, it prevents electric shock and short-circuit accidents that may occur due to direct contact of people's hand or tools such as drivers with the live current part. When the terminal cover is used, the protection grade of IP40 is applied to the power part. Based on the connection method of the circuit breaker, it can be classified into long or short type for use and various handles and interlock devices can be combined for use.

### Short Type

It is suitable for plug-in or rear connection.

### Long Type

It is suitable for front connection by using wires, bus bar or lug terminals.

Type						Application	Pitch (mm)
2P		3P		4P			
Short	Long	Short	Long	Short	Long		
TCF 10GM S2	TCF 10GM L2	TCF 10GM S3	TCF 10GM L3	TCF 10GM S4	TCF 10GM L4	HGM30, 50E/S, 60, 100 HGE30, 50E/S, 60, 100	25
TCF 12GM S2	TCF 12GM L2	TCF 12GM S3	TCF 12GM L3	TCF 12GM S4	TCF 12GM L4	HGM50H/L, 125 HGE50H/L, 125	30
TCF 25GM S3	TCF 25GM L3	TCF 25GM S3	TCF 25GM L3	TCF 25GM S4	TCF 25GM L4	HGM160, 250 HGE160, 250	35
TCF 40GM S3	TCF 40GM L3	TCF 40GM S3	TCF 40GM L3	TCF 40GM S4	TCF 40GM L4	HGM400 HGE400	44
TCF 80GM S3	TCF 80GM L3	TCF 80GM S3	TCF 80GM L3	TCF 80GM S4	TCF 80GM L4	HGM630, 800 HGE630, 800	70
TCF 10HD S2	-	TCF 10HD S3	-	-	-	HDB30, 50, 100 HDG30, 50, 100	25



Short Type



Long Type

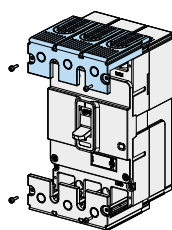

Assembly Diagram

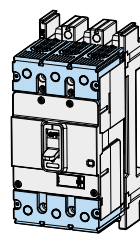

Short Type  
(Plug-in Connection)

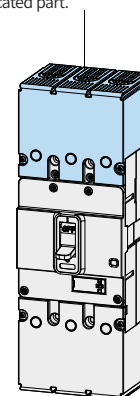

Long Type  
(Front Connection)

※ In case of using as front connection, please use it after removing the indicated part.

## External Accessories (HGM)

### Insulation Barrier

As a part used to prevent accidents with regards to insulation and conductive foreign substance between the circuit breaker terminals, it improves the performance of phase-to-phase insulation by installing it in the groove between the circuit breaker's terminals. It can easily be assembled even if the circuit breaker has already been installed and in case the two circuit breakers have been installed side by side, it can also be assembled in the gap between the two circuit breakers. In addition, it is used in the terminal cover and plug-in base.

※ In case insulation barrier is not mounted between the circuit breaker's terminal, it may cause secondary short-circuit accidents so it must be used.  
Insulation barrier must be installed towards the direction of the circuit breaker's line indication part.

Type			Application	No. of Parts (EA/Set)		
2P	3P	4P		2P	3P	4P
TQQ 10GM 2	TQQ 10GM 3	TQQ 10GM 4	HGM30, 50E/S, 60, 100 HGE30, 50E/S, 60, 100	1	2	3
TQQ 10GM 2	TQQ 10GM 3	TQQ 10GM 4	HGM50H/L, 125 HGE50H/L, 125	1	2	3
TQQ 25GM 2	TQQ 25GM 3	TQQ 25GM 4	HGM160, 250 HGE160, 250	1	2	3
TQQ 40GM 2	TQQ 40GM 3	TQQ 40GM 4	HGM400 HGE400	1	2	3
TQQ 40GM 2	TQQ 40GM 3	TQQ 40GM 4	HGM630, 800 HGE630, 800	1	2	3
TQQ 10HD 2	TQQ 10HD 3	-	HDB30, 50, 100 HDG30, 50, 100	2	4	-

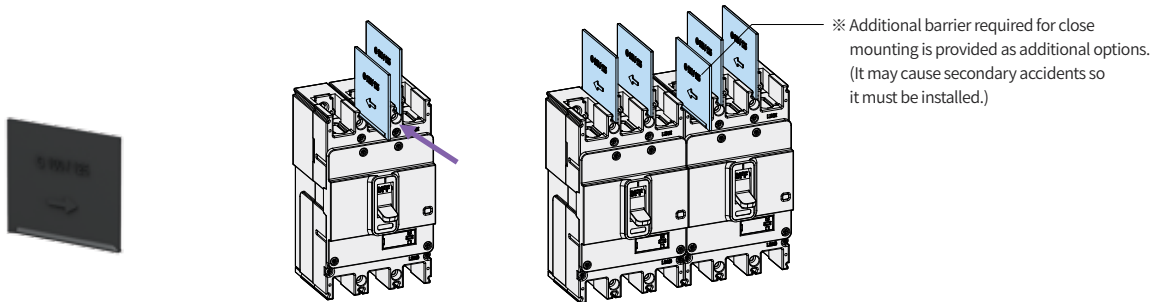

## Rotary Handle

Rotary handle is a product that can check and operate MCCB's ON/OFF/TRIP even when the panel door is closed by installing the circuit breaker in enclosed switchgear or on MCCB panel and others. There are two types of rotary handle, front contact type and extension type and all the rotary handles offer panel door locking function and handle locking function. The rotary handle can be rotated clockwise to turn the circuit breaker "ON" and according to the mounting direction of MCCB, it is categorized into the upper line, the right line and the left line. The IP rating of the handle is IP40/IP54.

### Front Contact Rotary Handle

- 32 ~ 250 AF : The handle is attached directly to the circuit breaker.
- 400 ~ 800 AF : The handle attached to the door of the panel.

### Extension Rotary Handle

It is suitable in case the distance between the circuit breaker and the panel door is long. The handle is attached to the door of the panel and there is no trip-button function.

Type			Application
Upper Line	Right Line	Left Line	
TFG 10GM U	TFG 10GM R	TFG 10GM L	HGM/HGE30, 50E/S, 60, 100
TFG 12GM U	TFG 12GM R	TFG 12GM L	HGM/HGE50H/L, 125
TFG 25GM U	TFG 25GM R	TFG 25GM L	HGM/HGE160, 250
TFG 40GM U	TFG 40GM R	TFG 40GM L	HGM/HGE400
TFG 80GM U	TFG 80GM R	TFG 80GM L	HGM/HGE630, 800

Type	Application
TFH 10GM	HGM/HGE30, 50E/S, 60, 100
TFH 12GM	HGM/HGE50H/L, 125
TFH 25GM	HGM/HGE160, 250
TFH 40GM	HGM/HGE400
TFH 80GM	HGM/HGE630, 800



Front Contact Rotary Handle  
(TFG-HGM)

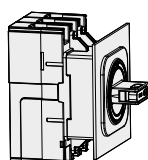

HGM30 ~ HGM250

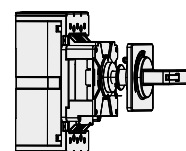

HGM400 ~ HGM800



Extension Rotary Handle  
(TFH-HGM)

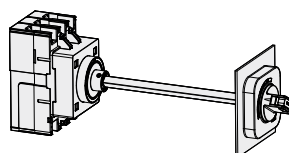

HGM30 ~ HGM250

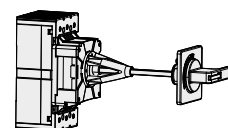

HGM400 ~ HGM800

※ When installing an extension rotary handle, the eccentric tolerance of the handle drive shaft is 1.5 degrees.

## External Accessories (HGM)

### Rotary Handle

#### Types of Handle Depending on the Circuit Breaker's Installation Type

Rotary handle is divided into the following three types depending on the circuit breaker's direction of power supply.

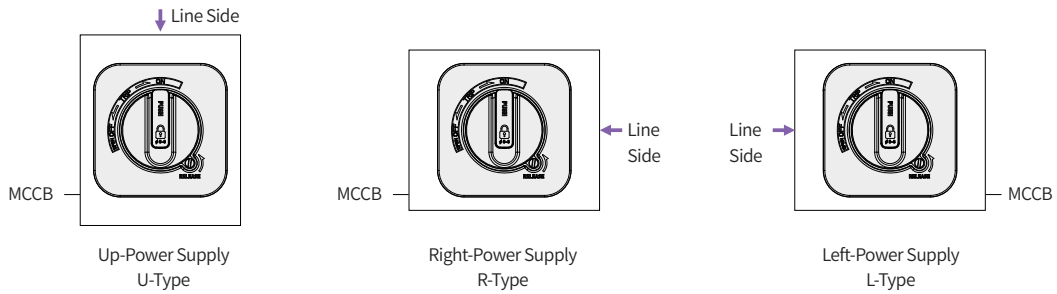

#### How to Operate the Handle

Operating Direction : Turn the handle clockwise to turn the breaker ON.

- Circuit Breaker ON : Rotate the handle to ON position. (Figure 1)
- Circuit Breaker OFF : Rotate the handle to OFF position. (Figure 2)
- Circuit Breaker TRIP : If the circuit breaker is tripped, the handle will automatically return to TRIP position. (Figure 3)
- After the circuit breaker is tripped, rotate the handle to the RESET position first (Figure 4) then rotate to the ON position and the circuit breaker will turn ON (Figure 1).
- If you need to open the door when the handle is in the ON state, rotate the RELEASE screw to the direction of the arrow then open the door (Figure 5).

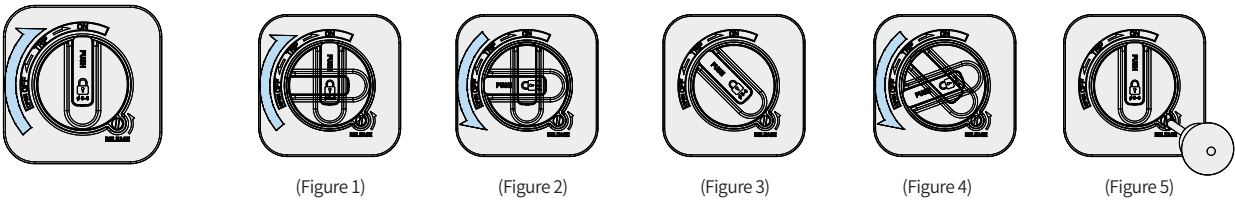

#### Handle Locking Device

Lock Function	OFF State Door Lock	ON State Door Lock	Reverse Interlock	Handle Padlock
Details	<ul style="list-style-type: none"> <li>• Impossible to open the panel door when the circuit breaker is in the OFF state.</li> <li>• Possible at RESET position</li> <li>• Possible to open the panel door after rotating the handle to RESET</li> </ul>	<ul style="list-style-type: none"> <li>• Impossible to open the panel door when the circuit breaker is in the ON state</li> <li>• Possible to open the panel door after rotating the RELEASE screw</li> </ul>	<ul style="list-style-type: none"> <li>• Impossible to close the circuit breaker (ON) in case the panel door is open</li> </ul>	<ul style="list-style-type: none"> <li>• Padlocking function which locks using a padlock to prevent handle operation.</li> <li>• Padlock is not provided separately and the number of padlocks depends on the padlock diameter. (Refer to the table below)</li> <li>• As for the specifications of the applicable padlocks, refer to the table below.</li> </ul>
Front Contact Type (TFG)	●	●	● (100/125/250 AF Only)	●
Extension Type (TFH)	●	●	-	●

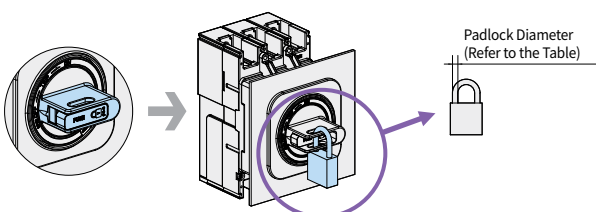

Application	Padlock Diameter <sup>1)</sup>	No. of Padlocks that can be Used
HGM/HGE30 ~ 250	6 ~ 8 mm	Ø6,Ø7 : 2 EA Ø8 : 1 EA
HGM/HGE400 ~ 800	5 ~ 7 mm	3 EA

※ 1) Padlock not included



## Front Connection of Fixed Devices

Straight/spreader bus bar or lug terminal can be selected for use depending on the size specification of the cable or bus bar to be connected to the circuit breaker.

### Insulated Bar Connection

In case the bus bar pitch of the switchgear is equal to the circuit breaker, it can be connected directly to the circuit breaker by using an insulation tube. Refer to the following connection bus bar specification for connection. Interphase barrier and terminal cover must be used.

Application	Connection Bus Bar Dimensions (mm)				Applicable Bolt and Tightening Torque	
	A	B	C	D	Bolt Spec.	Max. Tightening Torque (kgf×cm)
HGM/HGE 30, 50E/S, 60, 100	< 7.5	< 17	$\varnothing \geq 5.5$ ( $\leq 50$ A)	A + 7.5	M5 Screw ( $\leq 50$ A)	28.5
	< 7.5	< 17	$\varnothing \geq 9$ ( $> 50$ A)	A + 7.5	M8 Screw ( $> 50$ A)	110
HGM/HGE50H/L, 125	< 7.5	< 20	$\varnothing \geq 9$	A + 7.5	M8 Screw	110
HGM/HGE160, 250	< 10	< 27	$\varnothing \geq 9$	A + 10	M8 Hex Socket	110
HGM/HGE400	< 12.5	< 30	$\varnothing \geq 11$	A + 12.5	M10 Hex Socket	270
HGM/HGE630, 800	< 12.5	< 45	$\varnothing \geq 13$	A + 12.5	M12 Hex Socket	470

### Crimp Terminal

The terminal that conforms to the specification (crimped/copper tubing terminal) must be used and the interphase barrier and the terminal cover must be used. Select the terminal that meets the material and specification of the cable according to the circuit breaker's rating. The terminal is not provided separately. Refer to the table below for the wire specifications for the main ratings.

Application Type	Rated Current	Cu Cable Size (mm <sup>2</sup> )	Applicable Terminal Dimensions (mm)	
			A	B
HGM/HGE 30, 50E/S, 60, 100	32	6	$\varnothing \geq 5.5$	< 18
	50	10	$\varnothing \geq 5.5$	
	63	16	$\varnothing \geq 9$	
	100	35	$\varnothing \geq 9$	
HGM/HGE50H/L, 125	50	10	$\varnothing \geq 9$	< 21
	125	50	$\varnothing \geq 9$	
HGM/HGE160, 250	160	70	$\varnothing \geq 9$	< 28
	250	120	$\varnothing \geq 9$	
HGM/HGE400	400	240	$\varnothing \geq 11$	< 30
HGM/HGE630, 800	800	240×2	$\varnothing \geq 13$	< 45

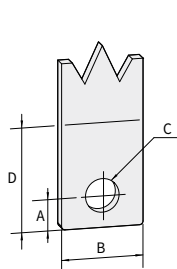

Connection Bus Bar

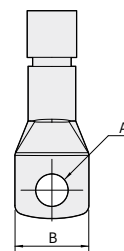
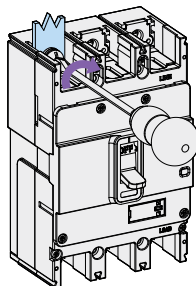

Crimped Terminal

## External Accessories (HGM)

### Front Connection of Fixed Devices

#### Busbar

##### Straight Busbar

It is used to meet the cable and standards of the switchgear.  
(Pitch between the poles maintained)

##### Spreader Busbar

It is used to extend the internal insulation distance of the switchgear. (Pitch between the poles extended)

Application	Straight			Spreader		Thickness
Type	Pole	Type	Pitch	Type	Pitch	
HGM/HGE 160, 250	2	TBB 25GP 2S	35 mm	-	45 mm	4 mm
	3	TBB 25GP 3S		TBB 25GP 3E45		
	4	TBB 25GP 4S		TBB 25GP 4E45		
HGM/HGE 400	2	TBB 40GM 2S	44 mm	-	59 mm	8 mm
	3	TBB 40GM 3S		TBB 40GM 3E59		
	4	TBB 40GM 4S		TBB 40GM 4E59		
HGM/HGE 630	2	TBB 63GM 2S	70 mm	-	-	8 mm
	3	TBB 63GM 3S		-		
	4	TBB 63GM 4S		-		
HGM/HGE 800	2	TBB 80GM 2S	70 mm	-	-	10 mm
	3	TBB 80GM 3S		-		
	4	TBB 80GM 4S		-		

#### LUG Terminal

As a part that connects the cable to the circuit breaker so that the cable can be used without crimp terminal, it must be selected according to the product's rating and size of cable.

Application	LUG Terminal			Applicable Cable				Tightening Torque (kgf×cm)
Type	Pole	Type	Material	EA	Material	S (mm <sup>2</sup> )	L (mm)	
HGM/HGE 30, 50E/S, 60, 100 (≤ 50 A)	2	CTB 10GM 2S50	Al	1	Cu/Al	2.5 ~ 16	14	60
	3	CTB 10GM 3S50						
	4	CTB 10GM 4S50						
HGM/HGE 60, 100 (> 50 A)	2	CTB 10GM 2S100	Al	1	Cu/Al	16 ~ 50	14	60
	3	CTB 10GM 3S100						
	4	CTB 10GM 4S100						
HGM/HGE 50H/L, 125	2	CTB 12GM 2S	Al	1	Cu/Al	2.5 ~ 70	14	60
	3	CTB 12GM 3S						
	4	CTB 12GM 4S						
HGM/HGE 160, 250	2	CTB 25GM 2S	Al	1	Cu/Al	50 ~ 180	19	140
	3	CTB 25GM 3S						
	4	CTB 25GM 4S						
HGM/HGE 400	3	CTB 40GM 3S1H	Al	1	Cu/Al	60 ~ 240	30 ~ 60	353
	4	CTB 40GM 4S1H				60 ~ 125		
HGM/HGE 400	3	CTB 40GM 3S	Al	2	Cu/Al	60 ~ 240	30 ~ 60	353
	4	CTB 40GM 4S						
HGM/HGE 630, 800	3	CTB 80GM 3S	Al	3	Cu/Al	60 ~ 185	30 ~ 60	353
	4	CTB 80GM 4S						

※ Quantity per Set : 2P - 2 EA, 3P - 3 EA, 4P - 4 EA

This type is inch type. For HGM100~250, ISO type (mm) is also available.



Straight  
Busbar



Spreader  
Busbar

LUG Terminal



HGM/HGE30 ~ 250



HGM400



HGM/HGE630, 800



○ S  
Wire

## Plug-in Connection Devices

If the plug-in connection method is used, the circuit breaker can be replaced quickly and accurately without separating the power cable during a malfunction of a circuit breaker. Therefore, if plug-in type circuit breaker is installed in important electrical facilities such as shipping, broadcast station and others, the circuit breaker can be replaced and maintained quickly and conveniently without disconnecting the bus bar.

- Applicable to 32 ~ 800 AF.
- Offers convenient maintenance of switchgear.
- Convenient and relaxed installation after manufacture of the switchgear.
- Circuit breaker can be removed or replaced quickly without touching the terminal connection area.
- Connection block can be made by connecting the internal accessory to the circuit breaker.
- Type : For switchgear (TDM/TDF), for distribution board (TDA)
- Composition : Plug-in devices, plug-in MCCB, terminal cover or insulation barrier (Option).

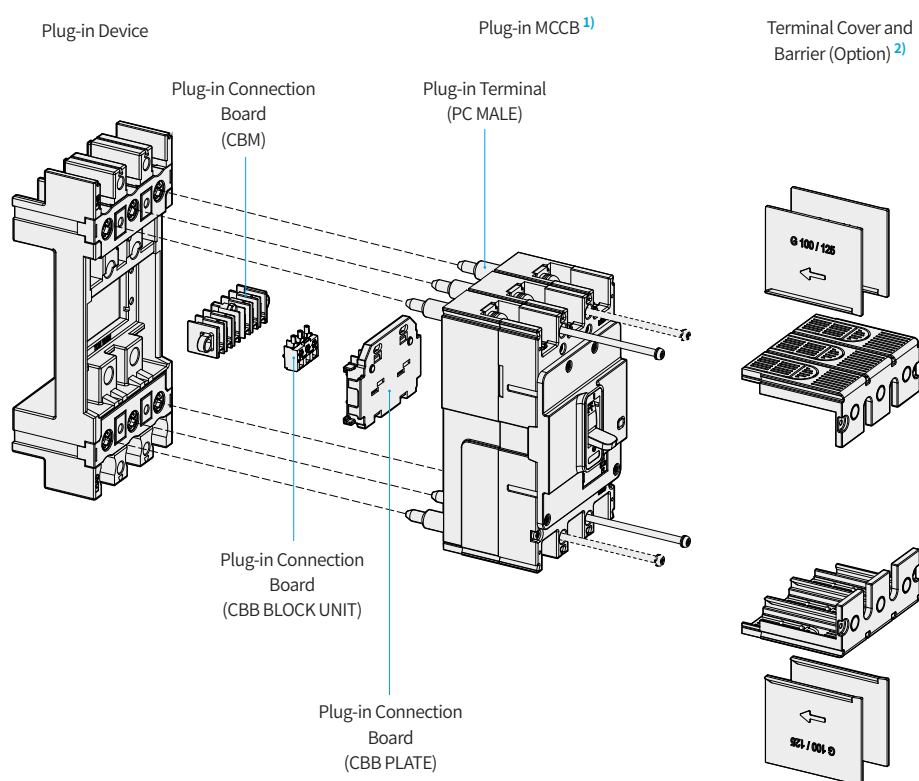

※ 1) Plug-in MCCB must be used to apply plug-in connection method.

2) In case of not using the terminal cover, be sure to install an interphase barrier.

# External Accessories (HGM)

## HG-MCCB Plug-in CBM Wiring Position (TDM Front Side)

Option	HGM30, 50E/S, 60, 100/2P	HGM30, 50E/S, 60, 100	HGM50H/L, 125, 160, 250	HGM400, 630, 800	HGP50D, 125D, 160D	HGP250	HGP630	HGP800
AUX								
AUX2								
AUX3								
ALT								
SHT/UVT								
AUX+ALT								
AUX2+ALT								
AUX3+ALT								
AUX+SHT/UVT								
AUX2+SHT/UVT								
AUX3+SHT/UVT								
ALT+SHT/UVT								
AUX+ALT+SHT/UVT								
AUX+ALT+SHT/UVT Max. Mounting Combination								

## Plug-in Connection Block

It is a connection block enables plug-in connection method, and it can be connected to the internal and external accessory of the circuit breaker.

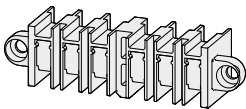
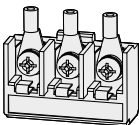
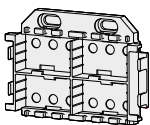
Application			
HGM100 (≤ 50 A)	CBM 10GM 2PUNIT (2P) CBM 10GM UNIT (3P)	CBB BLOCK UNIT CBB BLOCK UNIT2C	CBBPLATE 10GM
HGM100 (> 50 A)			CBBPLATE 40GM
HGM125			CBBPLATE 80GM
HGM250			
HGM400			
HGM800			
Quantity per Set	1	1	1

## Plug-in Terminal

It is a part that can implement the plug-in MCCB.

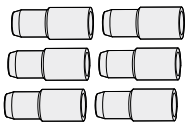
Application	
HGM100 (≤ 50 A)	PCMALE 10GM 50 A
HGM100 (> 50 A)	PCMALE 10GM 100 A
HGM125	PCMALE 12GM
HGM250	PCMALE 25GM
HGM400	PCMALE 40GM
HGM800	PCMALE 80GM
Quantity per Set	6

## External Accessories (HGM)

### Plug-in Devices



It is a connection block for plug-in MCCB installation and it is available according to the applicable panel and usage.

#### TDM Type

- TDM-P : It is comprised of plug-in terminal for both line/load for convenient use of connection block depending on the structure of the switchgear.
- TDM-F : Only plug-in parts of the line terminal are provided in TDM-P products.

#### TDF Type

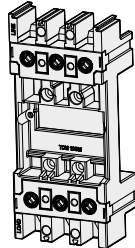
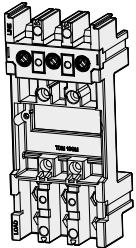
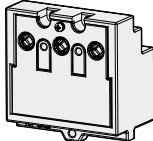
- Only the line terminal is comprised of plug-in terminal but the plug-in device can be fixed to the switchgear using the same method as TDM-P.

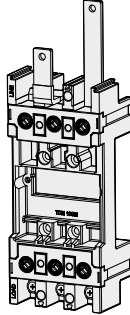
Applied Panel	Switchgear			Distribution Board	
Type	TDM-P	TDM-F	TDF	TDA (2 row)	TDA (1 row)
Composition					
Purpose	Line/Load Side	Line Side	Line Side	Duble Base	Single Base
HGM/HGE Type	32 ~ 800 AF	32 ~ 800 AF	32 ~ 125 AF	32 ~ 125 AF	32 ~ 125 AF
Pole	3P	3P	3P	2P (100 AF Only), 3P	3P

### Specification of Connection Busbar

The bus bar of the switchgear can directly be connected to the plug-in device. The specifications of the applicable bus bar are as below and the insulation barrier or terminal cover must be used.

Unit : mm

Product	A	B	C	D	Remark
HGM/HGE30, 50E/S, 60, 100	< 10	< 21	$\varnothing \geq 6.5$	< 17.5	
HGM/HGE50H/L, 125	< 10	< 21	$\varnothing \geq 6.5$	< 19.5	
HGM/HGE160, 250	< 17.5	< 25	$\varnothing \geq 8.5$	< 27.5	
HGM/HGE400	< 22	< 32	$\varnothing \geq 10.5$	< 38	
HGM/HGE630, 800	< 30	< 40	$\varnothing \geq 17$	< 48.5	

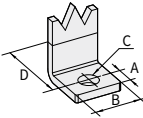
Product	A	B	C	D	Remark
HGM/HGE30, 50E/S, 60, 100	< 7.5	< 15	$\varnothing \geq 7$	< 13	
HGM/HGE50H/L, 125	< 7.5	< 15	$\varnothing \geq 7$	< 13	
HGM/HGE160, 250	-	-	-	-	
HGM/HGE400	-	-	-	-	
HGM/HGE630, 800	-	-	-	-	

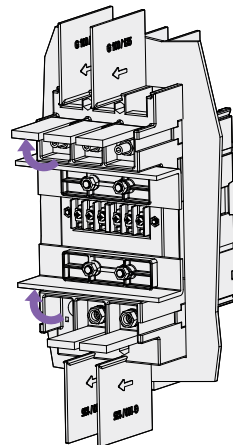

## Rear Connection Terminal

It is a part for rear connection instead of front connection requirement it applies the fixed type of circuit breaker to the switchgear. The bus bar of the switchgear can be wired vertically or horizontally depending on the assembly direction of the connection.

### Flat Type

Application		Rear Terminal		Quantity per Set	
Type	Pole	Line Side	Load Side	Short Terminal	Long Terminal
HGM/HGE 30, 50E/S, 60, 100 (≤ 50 A)	2	RCT 05GM F2		1	1
	3	RCT 05GM F3		2	1
	4	RCT 05GM F4		2	2
HGM/HGE 60, 100 (> 50 A)	2	RCT 10GM F2		1	1
	3	RCT 10GM F3		2	1
	4	RCT 10GM F4		2	2
HGM/HGE 50H/L, 125	2	RCT 12GM F2		1	1
	3	RCT 12GM F3		2	1
	4	RCT 12GM F4		2	2
HGM/HGE 160, 250	2	RCT 25GM F2		2	0
	3	RCT 25GM F3		2	1
	4	RCT 25GM F4		2	2
HGM/HGE 400	3	RCT 40GM F3 LINE	RCT 40GM F3 LOAD	2	1
	4	RCT 40GM F4 LINE	RCT 40GM F4 LOAD	2	2
HGM/HGE 630, 800	3	RCT 80GM F3 LINE	RCT 80GM F3 LOAD	2	1
	4	RCT 80GM F4 LINE	RCT 80GM F4 LOAD	2	2

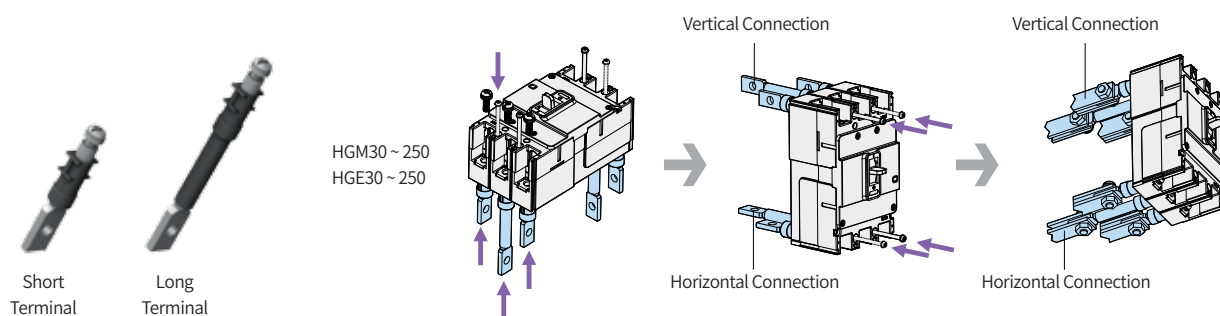

※When assembling the RCT, remove the back barrier in advance.

## DIN Rail Adaptor

This is a part that enables a separate adaptor to be assembled and mounted for rear connection with the circuit breaker when the circuit breaker is mounted on the DIN Rail. (HGM/HGE100 Only)

Application		Din Rail Adaptor	Quantity
Type	Pole		
HGM/HGE 30, 50E/S, 60, 100	2	DRA 10GM	1
	3	DRA 10GM	1
	4	DRA 10GM	2

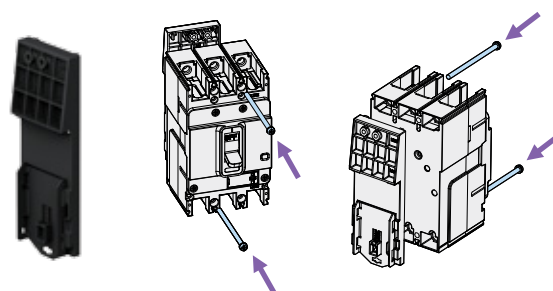

※ When assembling the DRA, remove the back barrier in advance.

## External Accessories (HGM)

### Motor Operator

This device is used for turning the circuit breaker ON/OFF in remote position.

It is convenient for establishing automation system for low-voltage system and for selecting load when operating under emergency power.

Application		MOT	Voltage
Type	Pole		
HGM30, 50E/S, 60, 100	3, 4	MOT 10GM	DC 24 V AC/DC 110 V AC/DC 240 V
HGM50H/L, 125	3, 4	MOT 12GM	
HGM160, 250	3, 4	MOT 25GM	
HGM400	3, 4	MOT 40GM	
HGM630, 800	3, 4	MOT 80GM	

### Rating and Characteristics

Format	Mechanical Lifespan	Operational Voltage	Operational Current (A)	Operating Time (ms)		Power Consumption (W)
				Closing	Opening	
MOT 10GM	10,000	DC 24 V	≤ 2.5	1,000	1,000	14
		AC/DC 110 V	≤ 0.5			
		AC/DC 240 V	≤ 0.5			
MOT 12GM	10,000	DC 24 V	≤ 2.5	1,000	1,000	14
		AC/DC 110 V	≤ 0.5			
		AC/DC 240 V	≤ 0.5			
MOT 25GM	8,000	DC 24 V	≤ 2.5	1,000	1,000	14
		AC/DC 110 V	≤ 0.5			
		AC/DC 240 V	≤ 0.5			
MOT 40GM	5,000	DC 24 V	≤ 6.0	1,200	1,200	14
		AC/DC 110 V	≤ 3.0			
		AC/DC 240 V	≤ 2.0			
MOT 80GM	5,000	DC 24 V	≤ 6.0	1,200	1,200	35
		AC/DC 110 V	≤ 3.0			
		AC/DC 240 V	≤ 2.0			

※ Operating Voltage Range : 85 ~ 110 % (DC 24 V : 95 ~ 110 %)

### Circuit and Wiring Drawing

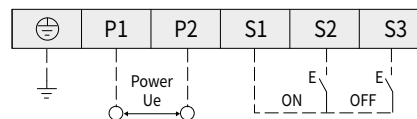
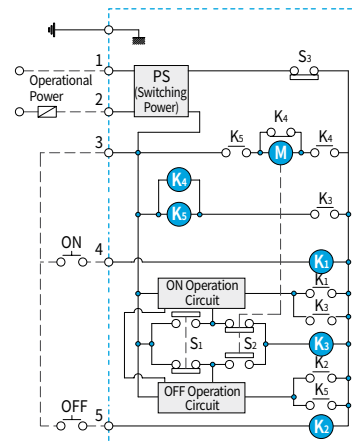

- : Motor
- : ON Relay
- : OFF Relay
- : Relay for Motor
- S1 : ON Limit Switch
- S2 : OFF Limit Switch
- S3 : Auto/Manual Limit Switch

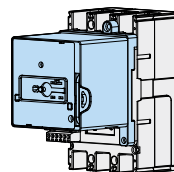

#### ※ Precaution for mounting

When mounting the motor operator on MCCB, it must be mounted when the MCCB's handle position is in OFF position. Mounting the motor operator in other positions (ON, TRIP) may cause damage to the motor.



## External Accessories (HGP)

### Locking Device

#### Padlock Device (PLD)

This device is used for locking the handle of circuit breaker to the OFF position by using a padlock. Padlock is not provided separately and up to 3 can be used. The applicable specifications of padlocks are as below.

#### Mechanical Interlock

This device interlocks two circuit breakers by using a mechanical interlock.

#### Key Features

- It prevents two breakers from closing at the same time.
- All circuit breakers are open. The applicable specifications of padlocks are as below.

Type	Application	Padlock Diameter <sup>1)</sup>
PLD 16GP	HGP50D, HGP125D, HGP160D	5 ~ 6 mm
PLD 25GP	HGP250 (HGP100/MCP)	
PLD 63GP	HGP400, HGP630	
PLD 80GP	HGP800	

Type	Application	Padlock Diameter <sup>1)</sup>
3P	4P	
MIF 16GP 3	MIF 16GP R4	HGP50D, HGP125D, HGP160D
MIF 25GP 3	MIF 25GP R4	HGP250 (HGP100/MCP)
MIF 63GP 3	MIF 63GP R4	HGP400, HGP630
MIF 80GP 3	MIF 80GP R4	HGP800

※ 1) Padlock not included

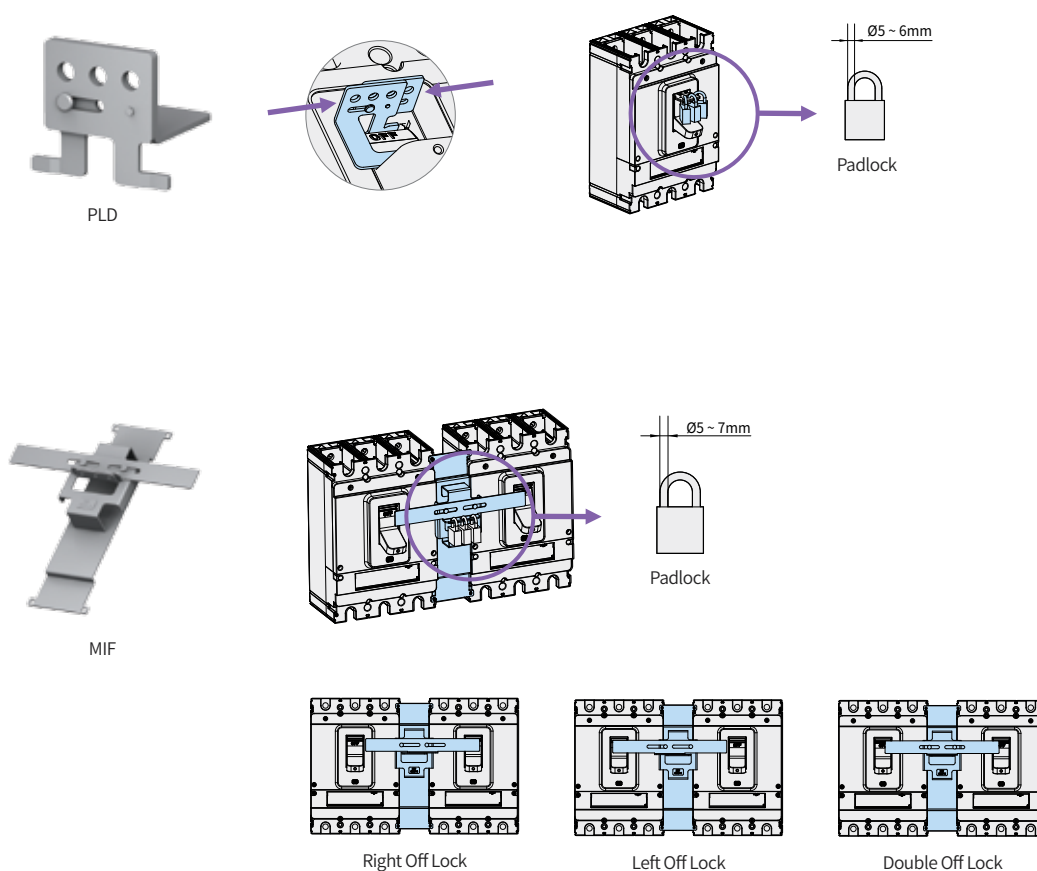

## External Accessories (HGP)

### Terminal Cover / Insulation Barrier

#### Terminal Cover

It is our insulation part of circuit breaker for live and load side of terminal area from the outside and it prevents electric shock and short-circuit accidents that may occur due to direct contact of people's hand or tools with the live current part. When the terminal cover is used, the protection degree of IP40 is applied to the conductor part. Based on the connection method of the circuit breaker, it can be classified into long or short type for use and various handles and interlock devices can be combined for use.

#### Short Type

It is suitable for plug-in or rear connection.

#### Long Type

It is suitable for front connection using wires, bus bar or lug terminals.

#### Insulation Barrier

As a part used to prevent accidents with regards to insulation and conductive foreign substance between the circuit breaker terminals, it improves the performance of phase-to-phase insulation by installing it in the groove between the circuit breaker's terminals. It can easily be assembled even if the circuit breaker has already been installed and in case the two circuit breakers have been installed side by side, it can also be assembled in the gap between the two circuit breakers. In addition, it is used in the terminal cover and plug-in base. In case insulation barrier is not mounted between the circuit breaker's terminal, it may cause secondary short-circuit accidents so it must be used.

Type			Application	Pitch (mm)	No. of Parts (EA/Set)
3P Short (Plug-in)	3P Long (3P)	4P Long (4P)			
TCF 16GP S3	TCF 16GP L3	TCF 16GP L4	HGP50D, HGP125D, HGP160D	30	1
TCF 25GP-G S3	TCF 25GP-G L3	TCF 25GP-G L4	HGP250 (HGP100/MCP)	35	1
TCF 63GP S3	TCF 63GP L3	TCF 63GF L4	HGP400, HGP630	46.5	1
TCF 80GP S3	TCF 80GP L3	TCF 80GF L4	HGP800	70	1

Type			No. of Parts (EA/Set)	
3P	4P	Application	3P	4P
TQQ 16GP 3	TQQ 16GP 4	HGP50D, HGP125D, HGP160D	4	6
TQQ 25GP-G 3	TQQ 25GP-G 4	HGP250 (HGP100/MCP)	4	6
TQQ 63GP 3	TQQ 63GP 4	HGP400, HGP630	4	6
TQQ 80GP 3	TQQ 80GP 4	HGP800	4	6



Terminal Cover Short Type



Terminal Cover Long Type



Insulation Barrier

※ In case of using as front connection, please use it after removing the indicated part.

※ Additional barrier required for close mounting is provided as additional options. (It may cause secondary accidents, so it must be installed.)

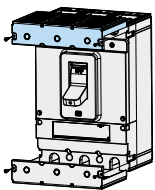

Assembly Diagram

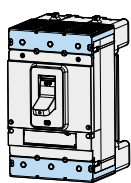

Short Type (Plug-in Connection)

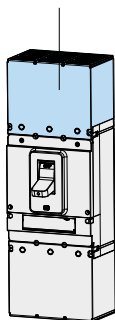

Long Type (Front Connection)

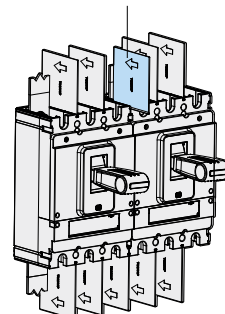
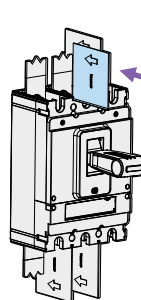

## Rotary Handle

Rotary handle is a product that can check and operate MCCB's ON/OFF/TRIP even when the panel door is closed by installing the circuit breaker in enclosed switchgear or on MCCB panel and others. There are two types of rotary handle, front contact type and extension type and all the rotary handles offer panel door locking function and handle locking function. The rotary handle can be rotated clockwise to turn the circuit breaker "ON" and according to the mounting direction of MCCB, it is categorized into the upper line, the right line and the left line. The IP grade of the handle is IP40/IP54.

### Front Contact Rotary Handle

- 160 ~ 250 AF : The handle is installed directly to the circuit breaker.
- 630 ~ 800 AF : The handle is installed to the door of the panel.

Type			Application
Upper Line	Right Line	Left Line	
TFG 16GP U	TFG 16GP R	TFG 16GP L	HGP50D, HGP125D, HGP160D
TFG 25GP U	TFG 25GP R	TFG 25GP L	HGP250 (HGP100/MCP)
TFG 63GP U	TFG 63GP R	TFG 63GP L	HGP400, HGP630
TFG 80GP U	TFG 80GP R	TFG 80GP L	HGP800

### Extension Rotary Handle

It is suitable if the distance between the circuit breaker and the panel door is long. The handle is installed to the door of the panel and there is no trip-button function.

Type	Application
TFH 16GP	HGP50D, HGP125D, HGP160D
TFH 25GP	HGP250 (HGP100/MCP)
TFH 63GP	HGP400, HGP630
TFH 80GP	HGP800

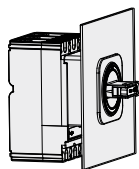

HGP50D, HGP125D  
HGP160D, HGP250

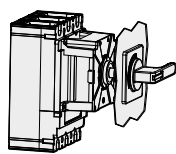

HGP400, HGP630  
HGP800

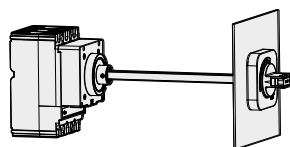

HGP50D, HGP125D  
HGP160D, HGP250

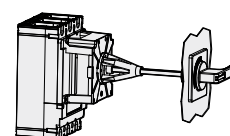

HGP400, HGP630  
HGP800

※ When installing an extension rotary handle, the eccentric tolerance of the handle drive shaft is 1.5 degrees.

## External Accessories (HGP)

### Rotary Handle

#### Types of Handle by the Circuit Breaker's Installation Type

Rotary handle is divided into the following three types by the circuit breaker's direction of power supply.

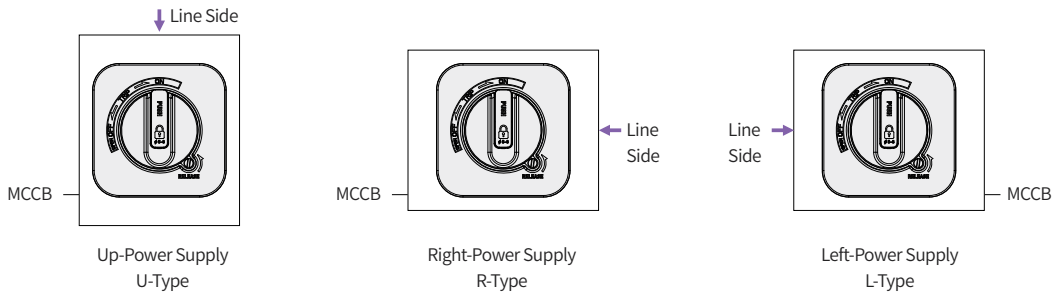

#### How to Operate the Handle

Operating Direction : Turn the handle clockwise to turn the breaker ON.

- Circuit Breaker ON : Rotate the handle to ON position. (Figure 1)
- Circuit Breaker OFF : Rotate the handle to OFF position. (Figure 2)
- Circuit Breaker TRIP : If the circuit breaker is tripped, the handle will automatically return to TRIP position. (Figure 3)
- After the circuit breaker is tripped, rotate the handle to the RESET position first (Figure 4) then rotate to the ON position and the circuit breaker will turn ON (Figure 1).
- If you need to open the door when the handle is in the ON state, rotate the RELEASE screw to the direction of the arrow then open the door (Figure 5).

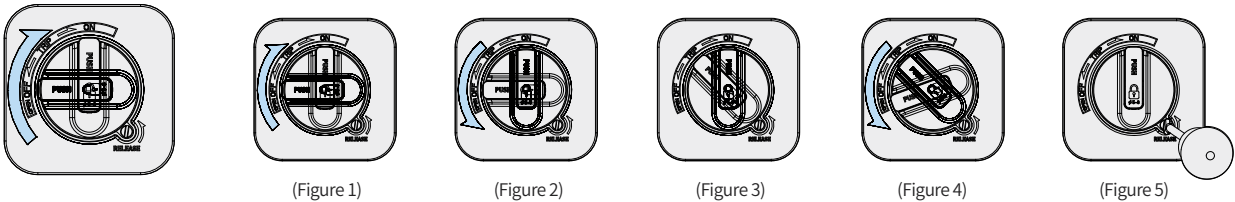

#### Handle Locking Device

Lock Function	OFF State Door Lock	ON State Door Lock	Reverse Interlock	Handle Padlock <sup>1)</sup>
Details	<ul style="list-style-type: none"> <li>• Impossible to open the panel door when the circuit breaker is in the OFF state.</li> <li>• Possible at RESET position</li> <li>• Possible to open the panel door after rotating the handle to RESET</li> </ul>	<ul style="list-style-type: none"> <li>• Impossible to open the panel door when the circuit breaker is in the ON state</li> <li>• Possible to open the panel door after rotating the RELEASE screw</li> </ul>	<ul style="list-style-type: none"> <li>• Impossible to close the circuit breaker (ON) in case the panel door is open</li> </ul>	<ul style="list-style-type: none"> <li>• Padlocking function which locks using a padlock to prevent handle operation.</li> <li>• Padlock is not provided separately and the number of padlocks depends on the padlock diameter. (Refer to the table below)</li> <li>• As for the specifications of the applicable padlocks, refer to the table below.</li> </ul>
Front Contact Type (TFG)	●	●	● (160/250 AF Only)	●
Extension Type (TFH)	●	●	-	●

※ 1) For TFG 250 AF or less, The handle remains ON when the circuit breaker is tripped after padlocking in ON position.

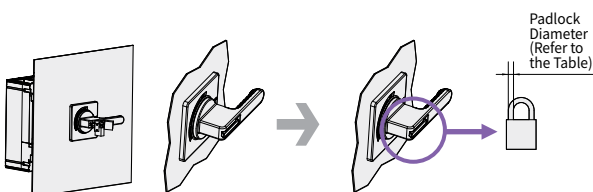

Application	Padlock Diameter <sup>1)</sup>
HGP50D, HGP125D, HGP160D, HGP250	6 ~ 8 mm
HGP400, HGP630, HGP800	5 ~ 7 mm

※ 1) Padlock not included

## Front Connection of Fixed Devices

Straight/spreader bus bar or lug terminal can be selected according to the size and specification of the cable or bus bar to be connected to the circuit breaker.

### Insulated Bar Connection

In case the bus bar pitch of the switchgear is equal to the circuit breaker, it can be connected directly to the circuit breaker by using an insulation tube. Refer to the following connection bus bar specification for connection and the insulation barrier between phases and terminal cover must be used.

Application	Connection Bus Bar Dimensions (mm)				Applicable Bolt and Tightening Torque	
	A	B	C	D	Bolt Spec.	Max. Tightening Torque (kgf×cm)
50 ~ 160 AF	< 9	< 22	Ø9	A+9	M8 Screw	136
250 AF	< 9	< 25	Ø9	A+10	M8 Hex Socket	136
400 ~ 630 AF	< 15	< 32	Ø10.5	A+15	M10 Hex Socket	270
800 AF	< 15.5	< 50	Ø13	A+16.5	M12 Hex Socket	470

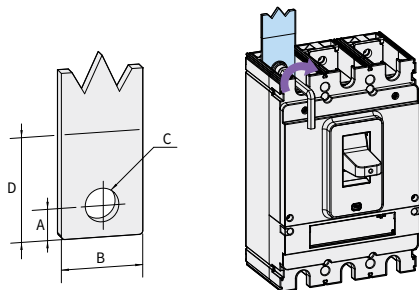

### Busbar

#### Straight Busbar

It is used to meet the cable and standards of the switchgear. (Pitch between the poles maintained)

#### Spreader Busbar

It is used to extend the internal insulation distance of the switchgear. (Pitch between the poles extended)

#### Series Busbar

Used for serial connection of adjacent phases. (DC only)

### Crimped Terminal

Standard terminals (crimped/copper tubing terminal) must be used and the insulation barrier between phases and the terminal cover must be used. Standard terminals must be selected for use according to the rating of the circuit breaker and the terminal is not provided separately. As for the cable specifications with regards to important ratings, refer to the table below.

Application	Rated Current	Cu Cable Size (mm <sup>2</sup> )	Applicable Terminal Dimensions (mm)		
			A	B	C
50 ~ 160 AF	100 A 160 A	35 70	Ø9	< 22	< 9
250 AF	160 A 250 A	70 120	Ø9	< 25	< 9
400 ~ 630 AF	400 A 630 A	240 185×2	Ø10.5	< 32	< 15
800 AF	800 A	240×2	Ø13	< 50	< 15.5

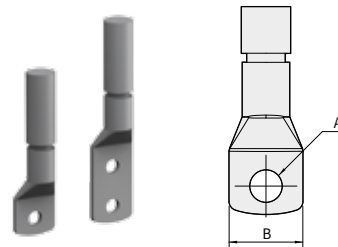

Straight Busbar



Spreader Busbar



Series Busbar

Application	Pole	Straight		Spreader		Series
		Type	Pitch	Type	Pitch	Type
HGP250	3	TBB 25GP 3S	35 mm	TBB 25GP 3E45	45 mm	SBB 25GP
	4	TBB 25GP 4S		TBB 25GP 4E45		
HGP630	3	TBB 63GP 3S	46.5 mm	TBB 63GP 3E61.5	61.5 mm	SBB 63GP
	4	TBB 63GP 4S		TBB 63GP 4E61.5		
HGP800	3	TBB 80GP 3S	70 mm	-	-	SBB 80GP
	4	TBB 80GP 4S		-		

※ Quantity per Set : 3P - 3 EA, 4P - 4 EA, SBB - 1 EA

## External Accessories (HGP)

### LUG Terminals

As a cable connection to the circuit breaker the cable can be used without crimped terminal, it must be selected according to the product's rating and size of cable.

Application		LUG Terminal		Application				Tightening Torque (kgf×cm)
Type	Pole	Type	Material	EA	Material	S (mm <sup>2</sup> )	L (mm)	
HGP50D HGP125D HGP160D	3 4	CTB 16GP 3 CTB 16GP 4	Steel	1	Cu/Al	1.5 ~ 95	19	140
HGP250 (HGP100/MCP)	3 4	CTB 25GP 3 CTB 25GP 4	Al	1	Cu/Al	14 ~ 185	19	
HGP400 HGP630	3 4	CTB 63GP 3 CTB 63GP 4	Al	2	Cu/Al	60 ~ 240	30 ~ 60	353
HGP800	3 4	CTB 80GP 3 CTB 80GP 4	Al	3	Cu/Al	60 ~ 185	30 ~ 60	

※ Packaging Quantity per Set : Provided in the composition quantity of line or load side (3P - 3 EA, 4P - 4 EA)



HGP50D  
HGP125D  
HGP160D



HGP250



HGP400  
HGP630



HGP800

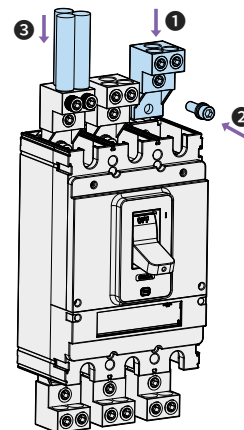
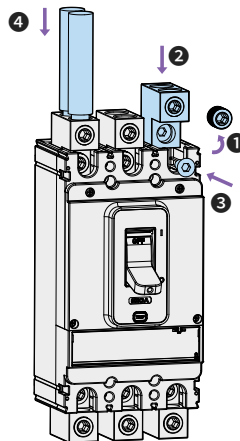
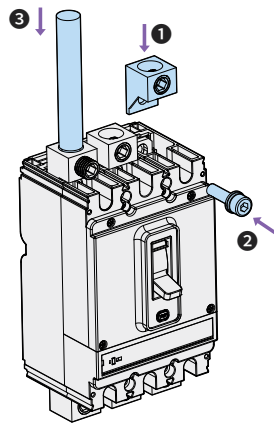
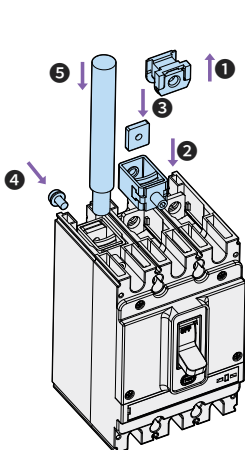
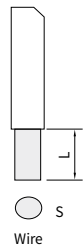

## Plug-in Connection Devices

When the plug-in connection method is used, the circuit breaker can be replaced quickly and accurately without power off during a malfunction of a circuit breaker. Therefore, in case the plug-in method of circuit breaker is installed in important electrical facilities such as shipping, broadcast station and others, the circuit breaker can be removed and maintained quickly and conveniently without disconnecting the bus bar.

- Applicable to 50 ~ 800 AF, up to 3P.
- Offers convenient maintenance of switchgear.
- Convenient and relaxed installation after manufacture of the switchgear.
- Circuit breaker can be removed or replaced quickly without touching the terminal connection area.
- Type : For switchboard (TDM/TDF)
- Composition : Plug-in devices, plug-in MCCB, terminal cover or insulation barrier (Option)

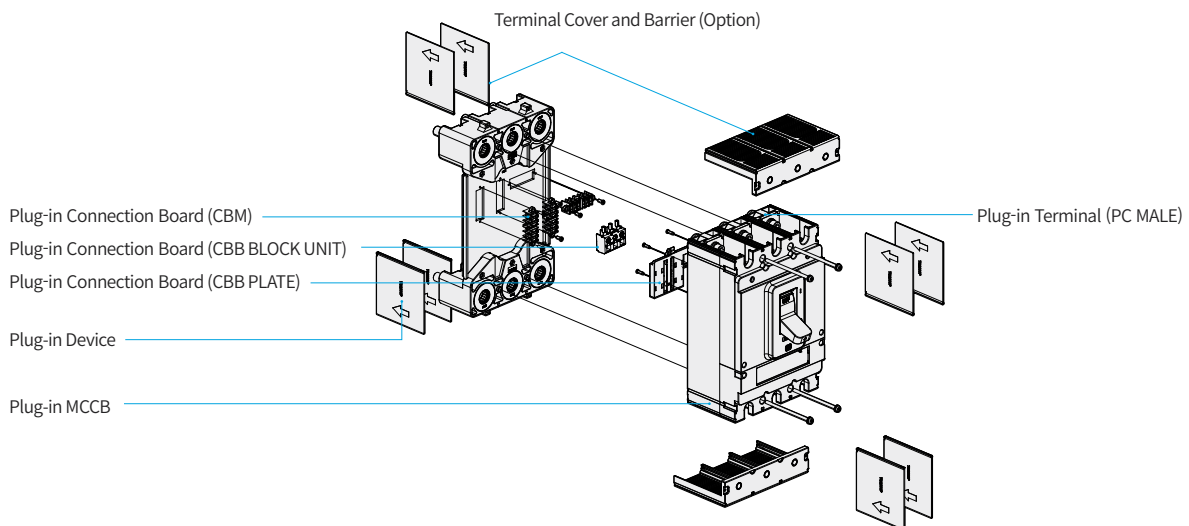

## Plug-in MCCB (For HGP)

In order to apply the plug-in connection method, the plug-in MCCB must be used instead of the general type, even for the MCCB. The product covers various breaking capacity up to the rated current of 800 A so this product conforms to the switchgear standard. Connection board (Connector) can be added to connect internal accessories to the circuit breaker.

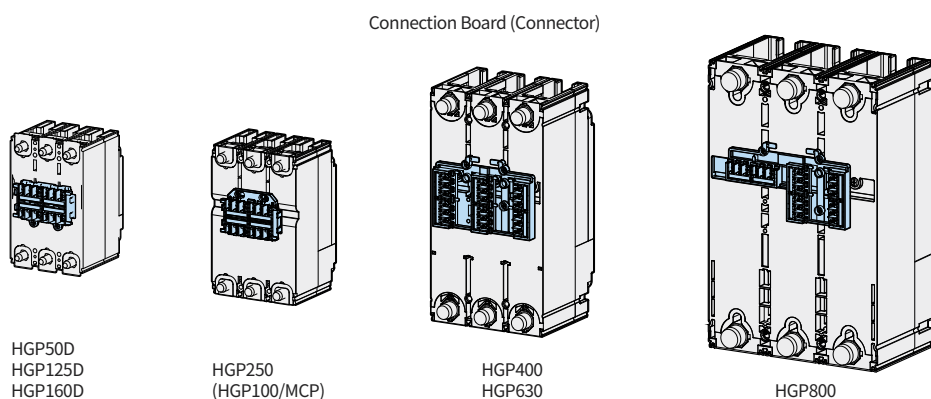

## External Accessories (HGP)

### Plug-in Connection Devices

#### Plug-in Devices

As a connection block in which plug-in MCCB can be installed, it is available according to the applied panel and the purpose.

#### TDM Type

- TDM-P : It is comprised of plug-in terminal for both line/load for convenient use of connection block depending on the structure of the switchgear.
- TDM-F : Only plug-in parts of the line terminal are provided in TDM-P products.

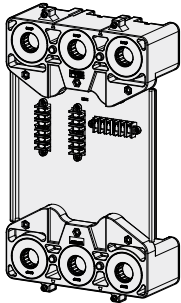
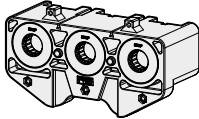
Applied Panel	For Switchgear	
Type	TDM-P	TDM-F
Composition		
Purpose	Line/Load Side	Line Side
Applicable MCCB	HGP50 ~ 800 AF 3P	

#### Specification of Connection Busbar

The bus bar of the switchgear can directly be connected to the plug-in device.

The specifications of the applicable bus bar are as below and the insulation barrier or terminal cover must be used.

There is no separate bus bar for connection.

Unit : mm

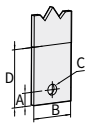
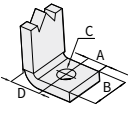
Product	A	B	C	D	Remark	Product	A	B	C	D	Remark
50 ~ 160 AF	< 12	< 21	$\varnothing \geq 8.5$	A + 18		50 ~ 160 AF	< 12	< 21	$\varnothing \geq 8.5$	< 12	
250 AF	< 18	< 25	$\varnothing \geq 8.5$	A + 17		250 AF	< 18	< 25	$\varnothing \geq 8.5$	< 18	
400 ~ 630 AF	< 34	< 35	$\varnothing \geq 10.5$	A + 26		400 ~ 630 AF	< 25	< 35	$\varnothing \geq 10.5$	< 25	
800 AF	< 30	< 40	$\varnothing \geq 16.5$	A + 30		800 AF	< 30	< 40	$\varnothing \geq 16.5$	< 30	

※ The insulation barrier for plug-in device is an option

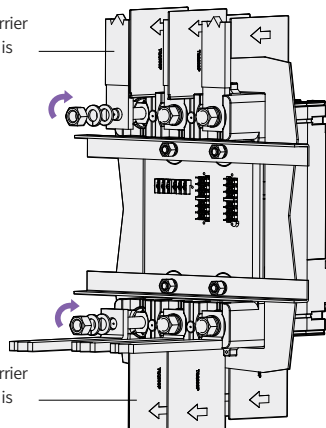

※ The insulation barrier for plug-in device is an option.



### HG-MCCB Plug-in CBM Wiring Position (TDM Front Side)

Option	HGP50D, HGP125D, HGP160D	HGP250 (HGP100/MCP)	HGP400, HGP630	HGP800
AUX				
AUX2				
AUX3				
ALT				
SHT/UVT				
AUX+ALT				
AUX2+ALT				
AUX3+ALT				
AUX+SHT/UVT				
AUX2+SHT/UVT				
AUX3+SHT/UVT				
ALT+SHT/UVT				
AUX+ALT+SHT/UVT				
AUX+ALT+SHT/UVT Max. Mounting Combination				

## External Accessories (HGP)

### Plug-in Connection Block

In order for the plug-in connection method, it can be connected to the internal and external accessory of the circuit breaker.

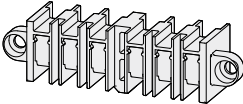
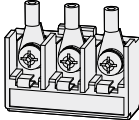
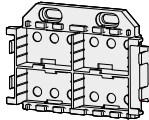
Application			
HGP160D	CBM 10GM UNIT (3P)	CBB BLOCK UNIT CBB BLOCK UNIT2C	CBBPLATE 16GP
HGP250			CBBPLATE 25GP
HGP630			CBBPLATE 63GP
HGP800			CBBPLATE 80GP
Quantity per Set			1

### Plug-in Terminal

It is a part that can realize the plug-in MCCB.

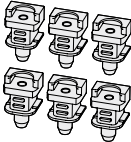
Application	
HGP160D	PCMALE 16GP
HGP250	PCMALE 25GP-G
HGP630	PCMALE 63GP
HGP800	PCMALE 80GP
Quantity per Set	6

## Rear Connection Terminal

It is a part that is used in case there is a need for rear connection instead of front connection by applying the fixed type of circuit breaker to the switchgear. The bus bar of the switchgear can be wired vertically or horizontally depending on the assembly direction of the connection.

### Flat Type

Application		Rear Terminal		Quantity per Set	
Type	Pole	Line Side	Load Side	Short Terminal	Long Terminal
HGP50D, HGP125D, HGP160D	3	RCT 16GP F3		2	1
	4	RCT 16GP F4		2	2
HGP250 (HGP100/MCP)	3	RCT 25GP-G F3		2	1
	4	RCT 25GP-G F4		2	2
HGP400 HGP630	3	RCT 63GP F3 LINE	RCT 63GP F3 LOAD	2	1
	4	RCT 63GP F4 LINE	RCT 63GP F4 LOAD	2	2
HGP800	3	RCT 80GP F3 LINE	RCT 80GP F3 LOAD	2	1
	4	RCT 80GP F4 LINE	RCT 80GP F4 LOAD	2	2

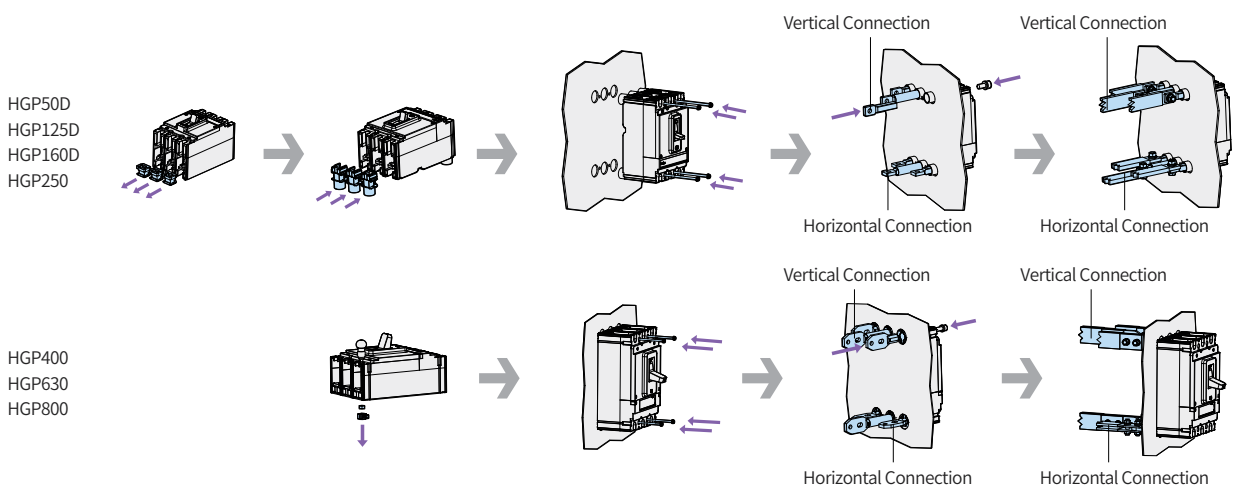
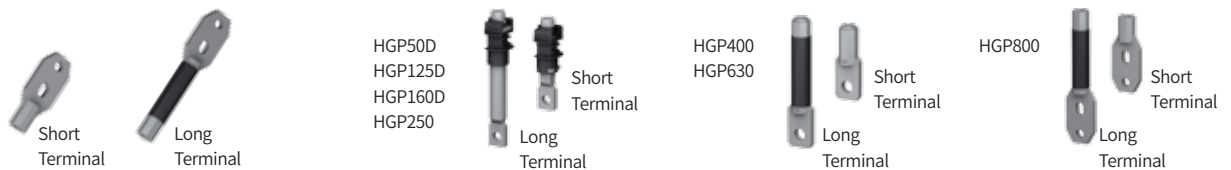

### Auxiliary Handle (THA)

As an auxiliary handle used to reduce the operating force of ON, OFF, RESET in large capacity circuit breaker (400 ~ 800 AF), it is a standard product provided. It comes together with a holder for storing auxiliary handle that can be fixed to the switchboard panel.

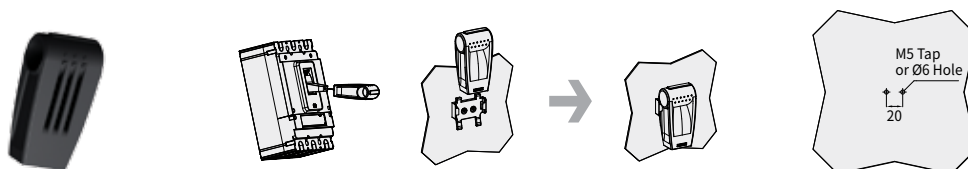

## External Accessories (HGP)

### Motor Operator

This device is used for turning the circuit breaker ON/OFF from remote position. It is convenient for establishing automation system for low-voltage load system and for selecting load when operating under emergency power.

Application		Pole	MOT	Voltage
Type				
HGP50D, HGP125D, HGP160D		3, 4	MOT 16GP	DC 24 V AC/DC 110 V AC/DC 240 V
HGP250 (HGP100/MCP)		3, 4	MOT 25GP	
HGP400, HGP630		3, 4	MOT 63GP	
HGP800		3, 4	MOT 80GP	

### Rating and Characteristics

Format	Operational voltage	Operational Current (A)	Operating Time (ms)		Power Consumption (W)	Endurance
			Closing	Opening		
MOT 16GP	DC 24 V	≤ 2.5				
	AC/DC 110 V	≤ 0.5	1,000	1,000	14	10,000
	AC/DC 240 V	≤ 0.5				
MOT 25GP	DC 24 V	≤ 2.5				
	AC/DC 110 V	≤ 0.5	1,000	1,000	14	10,000
	AC/DC 240 V	≤ 0.5				
MOT 63GP	DC 24 V	≤ 6.0				
	AC/DC 110 V	≤ 3.0	1,200	1,200	35	5,000
	AC/DC 240 V	≤ 2.0				
MOT 80GP	DC 24 V	≤ 6.0				
	AC/DC 110 V	≤ 3.0	1,200	1,200	35	5,000
	AC/DC 240 V	≤ 2.0				

※ Range of Operational Voltage : 85 ~ 110 % (DC 24 V : 95 ~ 110 %)

### Circuit and Wiring Drawing

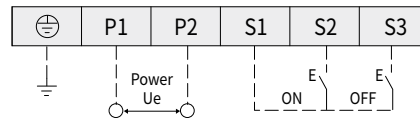
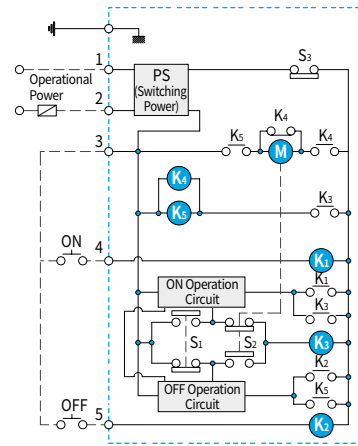

- : Motor
- : ON Relay
- : OFF Relay
- : Relay for Motor
- S1 : ON Limit Switch
- S2 : OFF Limit Switch
- S3 : Auto/Manual Limit Switch

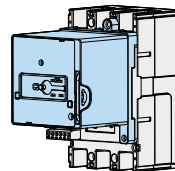

#### ※ Precaution for mounting

When mounting the motor operator on MCCB, it must be mounted when the MCCB's handle position is at in position. Mounting the motor operator in other positions (ON, TRIP) may cause damage to the motor.



# Technical Data (HGM/HGE)

## Environmental Operating Conditions

### Temperature Derating

The overcurrent characteristic of MCCB has been set to the ambient temperature of 40 °C. If the ambient temperature is less or more than 40 °C, the overcurrent characteristics may differ.

#### If the Ambient Temperature is lower than 40 °C

In order to ensure that the circuit breaker’s overcurrent meet the derating curve at the given ambient temperature, the real current (Ir) has to be adjusted. The temperature correction ratio or each MCCB is shown in the circuit breaker’s characteristics curve.

#### If the Ambient Temperature is higher than 40 °C

As the internal temperature of MCCB is a sum of increased temperature due to current flow and the ambient temperature, if the ambient temperature exceeds 40 °C, thermal damage of internal insulation material of MCCB may occur causing the circuit breaker to trip at an early stage. When applying ambient temperature higher than 40 °C, the rated current must be adjusted as shown in the following rated current derating table.

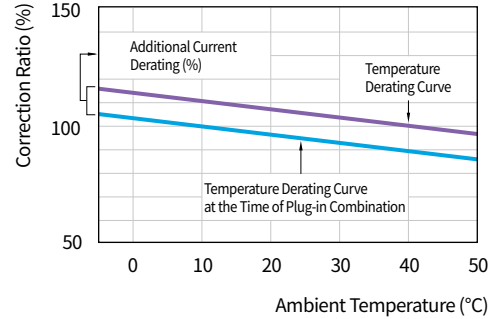

In (Rated Current) :  
Circuit breaker’s rating at ambient temperature of 40 °C  
Ir (Real Current) :  
Circuit breaker’s rating at the given temperature  
 $I_r = \text{Correction Ratio (\%)} \times I_n$

Rated Current Derating Table : HG Type/Standard Mounting

Model	Rated Current (A)	Ambient Temperature (°C)									
		10	20	30	40	45	50	55	60	65	70
HGM/HGE 30, 50E/S, 60, 100	16	18.9	18.6	17.8	16	15.2	14.6	14.1	13.6	13.2	12.8
	20	23.58	23.3	22.2	20	19.1	18.3	17.6	17.0	16.5	16.0
	25	26.8	26.2	25.6	25	24.7	24.4	24.1	23.8	23.5	23.2
	32	34.3	33.5	32.8	32	31.6	31.3	30.9	30.5	30.1	29.7
	40	42.9	41.9	41.0	40	39.5	39.0	38.6	38.1	37.6	37.1
	50	53.6	52.4	51.2	50	49.4	48.8	48.2	47.6	47.0	46.4
	63	67.5	66.0	64.5	63	62.2	61.5	60.7	60.0	59.2	58.5
	75	80.4	78.6	76.8	75	74.1	73.2	72.3	71.4	70.5	69.6
	80	85.8	83.8	81.9	80	79.0	78.1	77.1	76.2	75.2	74.2
HGM/HGE 50H/L, 125	100	107.2	104.8	102.4	100	98.8	97.6	96.4	95.2	94.0	92.8
	16	18.9	18.6	17.8	16	15.2	14.6	14.1	13.6	13.2	12.8
	20	23.6	23.3	22.2	20	19.1	18.3	17.6	17.0	16.5	16.0
	25	27.3	26.6	25.8	25	24.6	24.2	23.8	23.4	23.0	22.6
	32	35.0	34.0	33.0	32	31.5	31.0	30.5	30.0	29.5	29.0
	40	43.8	42.5	41.3	40	39.4	38.8	38.1	37.5	36.8	36.2
	50	54.7	53.1	51.6	50	49.2	48.4	47.7	46.9	46.1	45.3
	63	68.9	66.9	65.0	63	62.0	61.0	60.1	59.1	58.0	57.0
	75	82.0	79.7	77.3	75	73.8	72.7	71.5	70.3	69.1	67.9
HGM/HGE 160, 250	80	87.5	85.0	82.5	80	78.8	77.5	76.3	75.0	73.7	72.4
	100	109.4	106.3	103.1	100	98.4	96.9	95.3	93.8	92.1	90.5
	125	136.7	132.8	128.9	125	123.1	121.1	119.1	117.2	115.1	113.1
	100	107.8	105.2	102.6	100	96.0	94.0	92.0	88.0	85.5	83.0
	125	134.8	131.5	128.3	125	120.0	117.5	115.0	110.0	106.9	103.8
	150	161.7	157.8	153.9	150	144.0	141.0	138.0	132.0	128.3	124.5
	160	172.5	168.3	164.2	160	153.6	150.4	147.2	140.8	136.8	132.8
	175	188.7	184.1	179.6	175	168.0	164.5	161.0	154.0	149.6	145.3
	200	215.6	210.4	205.2	200	192.0	188.0	184.0	176.0	171.0	166.0
225	242.6	236.7	230.9	225	216.0	211.5	207.0	198.0	192.4	186.8	
250	269.5	263.0	256.5	250	240.0	235.0	230.0	220.0	213.8	207.5	

Rated Current Derating Table : HG Type/Standard Mounting

Model	Rated Current (A)	Ambient Temperature (°C)									
		10	20	30	40	45	50	55	60	65	70
HGM/HGE 400	250	269.5	263.0	256.5	250	246.8	243.5	240.2	237.0	233.6	230.3
	300	324	316.5	309	300	291	282	273	264	255	246
	350	378	369.25	360.5	350	340	330	320	310	300	290
	400	432	422	412	400	388	376	364	352	340	328
	500	540	527.5	515	500	485	470	455	440	425	410
HGM/HGE 630, 800	630	680.4	664.65	648.9	630	611	592	573	554	535	516
	700	756	738.5	721	700	679	658	637	616	595	574
	800	864	844	824	800	776	752	728	704	680	656

Rated Current Derating Table : HG Type/Plug-in Method

Model	Rated Current (A)	Ambient Temperature (°C)									
		10	20	30	40	45	50	55	60	65	70
HGM/HGE 30, 50E/S, 60, 100	16	18.5	18.3	17.4	16	14.9	14.3	13.8	13.3	12.9	12.5
	20	23.1	22.8	21.8	20	18.7	17.9	17.2	16.7	16.1	15.7
	25	26.3	25.7	25.1	25	24.2	23.9	23.6	23.3	23.0	22.7
	32	33.6	32.9	32.1	31	31.0	30.6	30.2	29.9	29.5	29.1
	40	42.0	41.1	40.1	39	38.7	38.3	37.8	37.3	36.8	36.4
	50	52.5	51.4	50.2	49	48.4	47.8	47.2	46.6	46.1	45.5
	63	66.2	64.7	63.2	62	61.0	60.3	59.5	58.8	58.0	57.3
	75	78.8	77.0	75.3	74	72.6	71.7	70.9	70.0	69.1	68.2
	80	84.0	82.2	80.3	78	77.5	76.5	75.6	74.6	73.7	72.8
	100	105.1	102.7	100.4	98	96.8	95.6	94.5	93.3	92.1	90.9
HGM/HGE 50H/L, 125	16	18.5	18.2	17.4	16	14.9	14.3	13.8	13.3	12.9	12.5
	20	23.1	22.8	21.8	20	18.7	17.9	17.2	16.7	16.1	15.7
	25	26.8	26.0	25.3	25	24.1	23.7	23.4	23.0	22.6	22.2
	32	34.3	33.3	32.3	31	30.9	30.4	29.9	29.4	28.9	28.4
	40	42.9	41.7	40.4	39	38.6	38.0	37.4	36.8	36.1	35.5
	50	53.6	52.0	50.5	49	48.2	47.5	46.7	45.9	45.1	44.4
	63	67.5	65.6	63.7	62	60.8	59.8	58.8	57.9	56.9	55.9
	75	80.4	78.1	75.8	74	72.4	71.2	70.1	68.9	67.7	66.5
	80	85.8	83.3	80.9	78	77.2	76.0	74.7	73.5	72.2	71.0
	100	107.2	104.1	101.1	98	96.5	94.9	93.4	91.9	90.2	88.7
HGM/HGE 160, 250	125	134.0	130.2	126.3	123	120.6	118.7	116.8	114.8	112.8	110.9
	100	103.5	101.0	98.5	96	92.2	90.2	88.3	84.5	82.1	79.7
	125	129.4	126.2	123.1	120	115.2	112.8	110.4	105.6	102.6	99.6
	150	155.3	151.5	147.8	144	138.2	135.4	132.5	126.7	123.1	119.5
	160	165.6	161.6	157.6	154	147.5	144.4	141.3	135.2	131.3	127.5
	175	181.1	176.7	172.4	168	161.3	157.9	154.6	147.8	143.6	139.4
	200	207.0	202.0	197.0	192	184.3	180.5	176.6	169.0	164.2	159.4
HGM/HGE 400	225	232.9	227.3	221.6	216	207.4	203.0	198.7	190.1	184.7	179.3
	250	258.7	252.5	246.2	240	230.4	225.6	220.8	211.2	205.2	199.2
	250	261.4	255.1	248.8	242.5	239.3	236.2	233.0	229.9	226.6	223.4
	300	314.3	307.0	299.7	291.0	282.3	273.5	264.8	256.1	247.4	238.6
	350	366.7	358.2	349.7	339.5	329.8	320.1	310.4	300.7	291.0	281.3
	400	405.2	395.8	387.6	378	373.7	367.9	363.2	357.9	352.6	347.3
	500	523.8	511.7	499.6	485.0	470.5	455.9	441.4	426.8	412.3	397.7
	HGM/HGE 630, 800	630	660.0	644.7	629.4	611.1	592.7	574.2	555.8	537.4	519.0
700		725.8	709.0	692.2	672.0	651.8	631.7	611.5	591.4	571.2	551.0
800		777.8	759.7	744.1	726	717.4	706.3	697.3	687	676.9	666.7

## Technical Data (HGM/HGE)

### Environmental Operating Conditions

#### Altitude Derating

The characteristics of the circuit breaker is not affected at an altitude of less than 2,000 m Characteristics of insulation and air cooling of the circuit breaker are reduced at an altitude of more than 2,000 m and the rated current and rated voltage must be adjusted as shown in the table below. However, there is no change in the characteristics of breaking capacity.

Circuit Breaker	Altitude	2,000 m	3,000 m	4,000 m	5,000 m
HGM Type MCCB 32 ~ 800 AF	Withstand Voltage (V)	3,000	2,500	2,100	1,800
	Insulation Voltage (V) $U_i$	1,000	850	750	600
	Maximum Operational Voltage (V) $U_e$	690	590	520	460
	Average Through-Current (A), at 40 °C $I_n x$	1	0.96	0.93	0.9
HGE Type ELCB 32 ~ 800 AF	Withstand Voltage (V)	3,000	2,500	2,100	1,800
	Maximum Operational Voltage (V) $U_e$	460	390	345	275
	Average Through-Current (A), at 40 °C $I_n x$	1	0.96	0.93	0.9

#### Vibrations

The excessive vibration may cause problems such as decrease of breaking capacity, lower dynamic, strength, reduction of electric current conductivity or compromising safety of operating characteristics. Therefore, proper consideration is required with regards to these environmental stresses when it comes to designating the circuit breakers. These stresses are generated by the vibration during transportation, magnetic impact during opening and closing operation and influence of adjacent devices. Our circuit breaker has been verified in accordance with the standards with regards to vibration resistance.

#### Vibration test

Vibration test is verified with the standard requested by the shipping certification institute in compliance with IEC 60068-2-6. Out of the vibration test items, resonance test and vibration Endurance test were verified based on the following standard.

#### Vibration Endurance test

A sinusoidal wave with frequency of 30 Hz is applied for 90 minutes to check for abnormalities.

- 30 Hz : 0.7 g Acceleration

#### Resonance test

It confirms whether vibration is generated in the characteristics part of MCCB by slowly changing the frequency in the frequency sector of the following sinusoidal wave.

- 5 ~ 13.2 Hz : 1 mm Displacement
- 13.2 ~ 100 Hz : 0.7 g Acceleration

#### Seismic Performance and Shock Tolerance Table

Item	Seismic
Test Condition Mounting Posture Direction of Vibration, Shock	<ul style="list-style-type: none"> <li>• Vertical mounting</li> <li>• Up-down, left-right, front-back</li> </ul>
Test Result	<ul style="list-style-type: none"> <li>• Non-conduction (ON of OFF status)</li> <li>• Status where rated current has been conducted on until the temperature of MCCB becomes constant and continuous</li> <li>• If it is ON, it should not turn OFF</li> <li>• If it is OFF, it should not turn ON</li> <li>• No abnormal status such as damage, deformation or loosened screw part</li> <li>• The characteristics of switch and trip after the test must be normal</li> </ul>



## Degree of Protection

The MCCB's IP rating is defined based on IEC 60529. The IP rating also depends on product conditions.

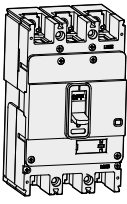
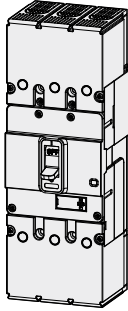
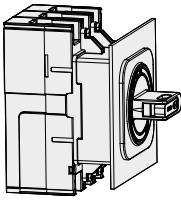
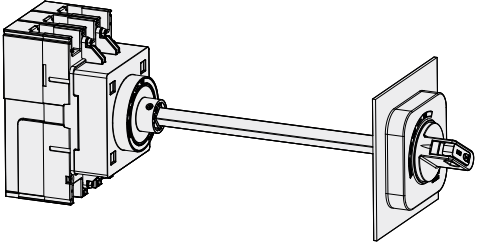

Condition	Circuit Breaker	Circuit Breaker + Terminal Cover	Circuit Breaker + Terminal Cover + Rotary Handle (Front Contact Type)	Circuit Breaker + Terminal Cover + Rotary Handle (Extension Type)
Appearance				
Protection Degree	IP20	IP40	IP40	IP40/IP54

※ 1) When applying IP54, please contact us separately.



## Technical Data (HGM/HGE)

### Power Loss / Resistance

#### HGM Type MCCB

Type	Rated Current (A)	HGM30, 50E/S, 60, 100		HGM50H/L, 125		HGM160, 250		HGM400		HGM630, 800		
		R/Pole (mΩ)	P/Pole (W)	R/Pole (mΩ)	P/Pole (W)	R/Pole (mΩ)	P/Pole (W)	R/Pole (mΩ)	P/Pole (W)	R/Pole (mΩ)	P/Pole (W)	
	16	16.0	4.10	17.0	4.35							
	20	16.0	6.40	17.0	6.80							
	25	4.0	2.50	4.3	2.69							
	32	4.0	4.10	3.0	3.07							
	40	2.9	4.64	1.9	3.06							
	50	2.3	5.75	1.6	3.90							
	63	1.2	4.88	0.9	3.37							
	75	0.7	4.11	0.6	3.38							
	80	0.9	5.76	0.6	3.84							
	100	0.7	7.30	0.6	5.60	0.6	5.60					
	125			0.5	7.97	0.4	6.72					
	150					0.4	8.55					
	160					0.3	8.70					
	175					0.3	9.80					
	200					0.3	10.80					
	225					0.3	13.67					
	250					0.2	13.75	0.2	14.38			
	300							0.2	18.90			
	350							0.2	23.28			
	400							0.2	27.20			
	500									0.1	30.00	
	630									0.1	39.60	
	700									0.1	53.90	
	800									0.1	64.00	
		16	16.1	4.12	17.1	4.37						
		20	16.1	6.43	17.1	6.83						
		25	4.1	2.55	4.4	2.74						
		32	4.1	4.18	3.1	3.15						
40		3.0	4.77	2.0	3.18							
50		2.4	5.95	1.6	4.10							
63		1.3	5.20	0.9	3.69							
75		0.8	4.56	0.7	3.83							
80		1.0	6.27	0.7	4.35							
100		0.8	8.10	0.6	6.40	0.6	6.40					
125				0.6	9.22	0.5	7.97					
150						0.5	10.35					
160						0.4	10.75					
175						0.4	12.25					
200						0.4	14.00					
225						0.4	17.72					
250						0.3	18.75	0.3	19.38			
300								0.3	26.10			
350								0.3	33.08			
400								0.3	40.00			
500										0.2	50.00	
630										0.2	68.40	
700										0.2	93.10	
800										0.2	115.20	

**HGE Type ELCB**

Type	Rated Current (A)	HGE30, 50E/S, 60, 100		HGE50H/L, 125		HGE160, 250		HGE400		HGE630, 800	
		R/Pole (mΩ)	P/Pole (W)	R/Pole (mΩ)	P/Pole (W)	R/Pole (mΩ)	P/Pole (W)	R/Pole (mΩ)	P/Pole (W)	R/Pole (mΩ)	P/Pole (W)
Fixed 	16	14.3	3.66	12.9	3.30						
	20	14.3	5.72	12.9	5.16						
	25	4.9	3.04	4.2	2.63						
	32	4.9	4.98	3.9	4.00						
	40	2.9	4.64	2.3	3.75						
	50	2.4	6.03	1.7	4.14						
	63	1.7	6.62	1.2	4.80						
	75	0.8	4.49	0.7	4.15						
	80	1.0	6.65	0.7	4.72						
	100	0.8	8.07	0.8	7.52	0.5	5.44				
	125			0.7	10.16	0.5	7.32				
	150					0.4	8.10				
	160					0.3	8.67				
	175					0.3	10.06				
	200					0.3	11.37				
	225					0.3	14.65				
	250					0.2	15.13	0.3	16.25		
	300							0.2	21.60		
	350							0.2	26.95		
	400							0.2	32.00		
500									0.2	40.00	
630									0.2	54.00	
700									0.1	68.60	
800									0.1	83.20	
Plug-in 	16	14.3	3.66	12.9	3.30						
	20	14.3	5.72	12.9	5.16						
	25	4.9	3.04	4.4	2.75						
	32	4.9	4.98	3.9	4.00						
	40	2.9	4.64	3.0	4.85						
	50	2.4	6.03	1.8	4.49						
	63	2.1	8.49	1.7	6.59						
	75	1.3	7.14	1.1	6.40						
	80	1.0	6.65	1.1	7.28						
	100	1.0	9.77	0.8	8.42	0.5	5.44				
	125			0.7	11.56	0.5	7.32				
	150					0.4	8.10				
	160					0.3	8.67				
	175					0.3	10.06				
	200					0.3	11.37				
	225					0.3	14.65				
	250					0.2	15.13	0.3	21.25		
	300							0.3	28.80		
	350							0.3	36.75		
	400							0.3	44.80		
500									0.2	60.00	
630									0.2	82.80	
700									0.2	107.80	
800									0.2	134.40	

# Technical Data (HGM/HGE)

## Cascading Table

### AC 220/240 V

Upstream Circuit Breaker : HGM30, HGM50, HGM60, HGM100, HGM125, HGM160, HGM250, HGM400

Downstream Circuit Breaker : HGD32, HGD63, HGD125, HGM30, HGM50, HGM60, HGM100

Upstream Circuit Breaker	HGM30		HGM50				HGM60				HGM100			
	E	S	E	S	H	L	E	S	H	L	E	S	H	L
Breaking Capacity [Icu] (kA r.m.s.)	35	50	35	50	85	100	35	50	50	50	35	50	50	50
Downstream Breaking Capacity [Icu] (kA r.m.s.)	Enhanced Breaking Capacity													
HGD63E	10	15	15	15	15	15	15	15	15	15	15	15	15	15
HGD63S	15	20	20	20	20	20	20	20	20	20	20	20	20	20
HGD32NS, HGD63N/M	20			35	40	40	40	35	40	40	40	35	40	40
HGD63H/P	25			35	50	50	50	35	40	40	40	35	40	40

Upstream Circuit Breaker	HGM125				HGM160				HGM250			
	E	S	H	L	E	S	H	L	E	S	H	L
Breaking Capacity [Icu] (kA r.m.s.)	50	65	85	100	50	65	85	100	50	65	85	100
Downstream Breaking Capacity [Icu] (kA r.m.s.)	Enhanced Breaking Capacity											
HGD63E	10	15	15	15	15	15	15	15	15	15	15	15
HGD63S	15	20	20	20	20	20	20	20	20	20	20	20
HGD32NS, HGD63N/M	20	40	40	40	40	40	40	40	40	40	40	40
HGD63H/P	25	40	50	50	50	40	50	50	50	40	50	50
HGD100S/125	25	40	40	40	40	40	40	40	40	40	40	40

Upstream Circuit Breaker	HGM30		HGM50				HGM60				HGM100			
	E	S	E	S	H	L	E	S	H	L	E	S	H	L
Breaking Capacity [Icu] (kA r.m.s.)	35	50	35	50	85	100	35	50	50	50	35	50	50	50
Downstream Breaking Capacity [Icu] (kA r.m.s.)	Enhanced Breaking Capacity													
HGM30E	35	50		50	65	65		50	50	50		50	50	50
HGM50E	35			50	65	70		50	50	50		50	50	50
HGM50S	50				70	85								
HGM50H	85					100								
HGM60E	35							50	50	50		50	50	50
HGM100E	35											50	50	50

Upstream Circuit Breaker	HGM125				HGM160				HGM250				HGM400			
	E	S	H	L	E	S	H	L	E	S	H	L	E	S	H	L
Breaking Capacity [Icu] (kA r.m.s.)	50	65	85	100	50	65	85	100	50	65	85	100	50	75	100	125
Downstream Breaking Capacity [Icu] (kA r.m.s.)	Enhanced Breaking Capacity															
HGM30E	35	50	65	65	65	50	65	65	50	65	65	65	50	65	65	65
HGM30S	50		65	65	65		65	65		65	65	65		65	65	65
HGM50E	35	50	65	65	70	50	65	65	70	50	65	65	70	50	65	65
HGM50S	50		65	70	85		65	70	85		65	70	85		65	70
HGM50H	85				100				100				100			100
HGM60E	35	50	65	70	70	50	65	70	70	50	65	70	70	50	65	70
HGM60S	50		65	70	70		65	70	70		65	70	70		65	70
HGM60H	50		65	70	70		65	70	70		65	70	70		65	70
HGM60L	50		65	70	70		65	70	70		65	70	70		65	70
HGM100E	35	50	65	70	70	50	65	70	70	50	65	70	70	50	65	70

Upstream Circuit Breaker : HGM125, HGM160, HGM250, HGM400, HGM630, HGM800

Downstream Circuit Breaker : HGM100, HGM160, HGM250, HGM400, HGM630, HGM800

Upstream Circuit Breaker	HGM125				HGM160				HGM250				HGM400				
	E	S	H	L	E	S	H	L	E	S	H	L	E	S	H	L	
Breaking Capacity [Icu] (kA r.m.s.)	50	65	85	100	50	65	85	100	50	65	85	100	50	75	100	125	
Downstream Breaking Capacity [Icu] (kA r.m.s.)	Enhanced Breaking Capacity																
HGM100S	50	65	70	70		65	70	70		65	70	70		65	70	70	
HGM100H	50		65	70	70		65	70	70		65	70	70		65	70	70
HGM100L	50		65	70	70		65	70	70		65	70	70		65	70	70
HGM125E	50		65	85	100		65	85	100		65	85	100		65	85	100
HGM125S	65			85	100			85	100			85	100			85	100
HGM125H	85				100				100				100				100

Upstream Circuit Breaker	HGM160				HGM250				HGM400				
	E	S	H	L	E	S	H	L	E	S	H	L	
Breaking Capacity [Icu] (kA r.m.s.)	50	65	85	100	50	65	85	100	50	75	100	125	
Downstream Breaking Capacity [Icu] (kA r.m.s.)	Enhanced Breaking Capacity												
HGM160E	50		65	85	100		65	85	100		75	85	100
HGM160S	65			85	100			85	100			85	100
HGM160H	85				100				100			100	125
HGM160L	100												125
HGM250E	50					65	85	100		75	85	100	
HGM250S	65						85	100			85	100	
HGM250H	85							100			100	125	
HGM250L	100											125	

Upstream Circuit Breaker	HGM630				HGM800			
	E	S	H	L	S	H	L	
Breaking Capacity [Icu] (kA r.m.s.)	50	75	100	125	75	100	125	
Downstream Breaking Capacity [Icu] (kA r.m.s.)	Enhanced Breaking Capacity							
HGM250E	50		75	85	100	75	85	100
HGM250S	65			85	100		85	100
HGM250H	85			100	125		100	125
HGM250L	100				125			125
HGM400E	50		75	85	100	75	85	100
HGM400S	75			85	100		85	100
HGM400H	100				125			125
HGM630E	50		75	85	100	75	85	100
HGM630S	75			85	100		85	100
HGM630H	100				125			125
HGM800S	75						70	85
HGM800H	100							85

# Technical Data (HGM/HGE)

## Cascading Table

### AC 440/460 V

Upstream Circuit Breaker : HGM30, HGM50, HGM60, HGM100, HGM125, HGM160, HGM250, HGM400

Downstream Circuit Breaker : HGD32, HGD63, HGD125, HGM30, HGM50, HGM60, HGM100

Upstream Circuit Breaker	HGM30		HGM50				HGM60				HGM100			
	E	S	E	S	H	L	E	S	H	L	E	S	H	L
Breaking Capacity [Icu] (kA r.m.s.)	16	20	16	20	38	55	16	20	26	30	16	20	26	30
Downstream Breaking Capacity [Icu] (kA r.m.s.)	Enhanced Breaking Capacity													
HGD63E	3	10	10	10	10	10	10	10	10	10	10	10	10	10
HGD63S	4.5	14	14	14	14	14	14	14	14	14	14	14	14	14
HGD32NS, HGD63N/M	6			16	20	20	20	16	20	20	20	16	20	20
HGD63H/P	10			16	20	26	26	16	20	20	20	16	20	20

Upstream Circuit Breaker	HGM125				HGM160				HGM250			
	E	S	H	L	E	S	H	L	E	S	H	L
Breaking Capacity [Icu] (kA r.m.s.)	20	26	38	55	20	26	38	55	20	26	38	55
Downstream Breaking Capacity [Icu] (kA r.m.s.)	Enhanced Breaking Capacity											
HGD63E	3	10	10	10	10	10	10	10	10	10	10	10
HGD63S	4.5	14	14	14	14	14	14	14	14	14	14	14
HGD32NS, HGD63N/M	6	16	20	20	20	16	20	20	20	16	20	20
HGD63H/P	10	16	20	26	26	16	20	26	26	16	20	26
HGD100S/125	10	16	20	26	26	16	20	26	26	16	20	26

Upstream Circuit Breaker	HGM30		HGM50				HGM60				HGM100			
	E	S	E	S	H	L	E	S	H	L	E	S	H	L
Breaking Capacity [Icu] (kA r.m.s.)	16	20	16	20	38	55	16	20	26	30	16	20	26	30
Downstream Breaking Capacity [Icu] (kA r.m.s.)	Enhanced Breaking Capacity													
HGM30E	16	20		20	26	30		20	20	20		20	20	20
HGM30S	20				30	30			26	26			26	26
HGM50E	16			20	26	30		20	20	20		20	20	20
HGM50S	20				30	38			26	26			26	26
HGM50H	38					55								
HGM60E	16							20	20	20		20	20	20
HGM60S	20								26	26			26	26
HGM60H	26									30				30
HGM100E	16											20	20	20
HGM100S	20												26	26
HGM100H	26													30

Upstream Circuit Breaker	HGM125				HGM160				HGM250				HGM400			
	E	S	H	L	E	S	H	L	E	S	H	L	E	S	H	L
Breaking Capacity [Icu] (kA r.m.s.)	20	26	38	55	20	26	38	55	20	26	38	55	38	50	70	85
Downstream Breaking Capacity [Icu] (kA r.m.s.)	Enhanced Breaking Capacity															
HGM30E	16	20	26	30	20	26	26	30	20	26	26	30	26	26	30	30
HGM30S	20	26	30	30		26	30	30		26	30	30		30	30	30
HGM50E	16	20	26	30	20	26	30	30	20	26	30	30	20	26	30	30
HGM50S	20	26	30	38		26	30	38		26	30	38	20	30	38	38
HGM50H	38			55				55				55		50	70	70
HGM50L	55													70	70	
HGM60E	16	20	26	30	20	26	26	30	20	26	26	30	26	26	30	30
HGM60S	20	26	30	30		26	30	30		26	30	30	26	30	30	30
HGM60H	26		30	38			30	38			30	38	30	38	38	38
HGM60L	30			38				38				38		38	38	38
HGM100E	16	20	26	30	20	26	26	30	20	26	26	30	26	26	30	30
HGM100S	20	26	30	30		26	30	30		26	30	30	26	30	30	30
HGM100H	26		30	38			30	38			30	38	30	38	38	38
HGM100L	26			38				38				38		38	38	38

Upstream Circuit Breaker : HGM125, HGM160, HGM250, HGM400, HGM630, HGM800

Downstream Circuit Breaker : HGM100, HGM160, HGM250, HGM400, HGM630, HGM800

Upstream Circuit Breaker	HGM125				HGM160				HGM250				HGM400			
	E	S	H	L	E	S	H	L	E	S	H	L	E	S	H	L
Breaking Capacity [Icu] (kA r.m.s.)	20	26	38	55	20	26	38	55	20	26	38	55	38	50	70	85
Downstream Breaking Capacity [Icu] (kA r.m.s.)	Enhanced Breaking Capacity															
HGM125E	20	26	30	38		26	30	38		26	30	38	26	30	38	38
HGM125S	26		38	38			38	38			38	38		38	50	50
HGM125H	38			55				55				55		50	70	70
HGM125L	55														70	70
HGM160E	20					26	30	38		26	30	38	26	30	38	38
HGM160S	26						38	50			38	50	30	38	50	50
HGM160H	38							55				55		50	70	70
HGM160L	55														70	70

Upstream Circuit Breaker	HGM250				HGM400				HGM630				HGM800			
	E	S	H	L	E	S	H	L	E	S	H	L	S	H	L	
Breaking Capacity [Icu] (kA r.m.s.)	20	26	38	55	38	50	70	85	38	50	70	85	50	70	85	
Downstream Breaking Capacity [Icu] (kA r.m.s.)	Enhanced Breaking Capacity															
HGM250E	20	26	30	38	26	30	38	38	26	30	38	38	30	38	38	
HGM250S	26		38	50	30	38	50	50	30	38	50	50	38	50	50	
HGM250H	38			55		50	70	70		50	70	70	50	70	70	
HGM250L	55						70	70			70	70		70	70	
HGM400E	38					50	70	70		50	70	70	50	70	70	
HGM400S	50						70	85			70	85		70	85	
HGM400H	70							85				85			85	
HGM630E	38									50	70	70	50	70	70	
HGM630S	50										70	85		70	85	
HGM630H	70											85			85	
HGM800S	50													70	85	
HGM800H	70														85	

# Technical Data (HGM/HGE)

## Installation

### Insulation Distance (Safety Clearance)

For safety, insulation distance must be secured at installation. In case of installing a circuit breaker, safety clearances must be secured between breakers or between the circuit breaker and panel, bus bar and other adjacent devices. When the circuit breaker interrupts a short circuit, high temperature ionized gas is generated and the gas is discharged through the discharge outlet from the circuit breaker. As this gas can cause short-circuit accidents and grounding accidents, sufficient insulation distance is required between the circuit breaker and the panel.

※ In case insulation barrier is not installed between the circuit breaker terminals, secondary short-circuit accident may occur so it must be used.  
The insulation barrier must be installed towards the direction of the circuit breaker's line indication part.

Separation distance in case the circuit breaker is installed side by side

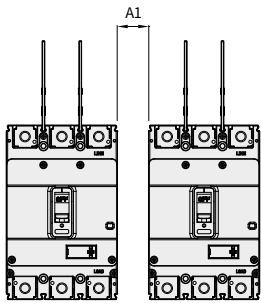

※ In case of using the minimum separation distance (A1 = 0), terminal cover and phase to phase barrier must be assembled between the product. And pay attention to the tolerances of the enclosure dimensions.

Up/down/left/right distance in case of metallic panel

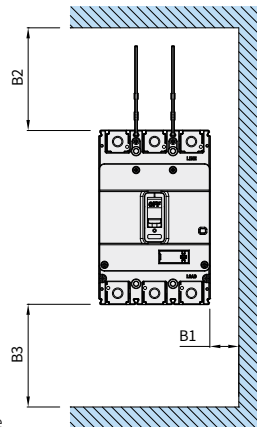

Front/back distance in case of metallic panel

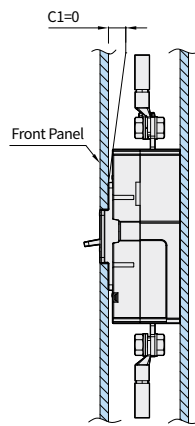

Distance with circuit breaker in case the live part is exposed

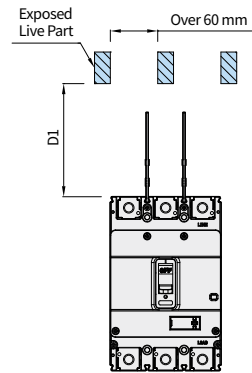

※ If the distance between the live parts is less than 60 mm, the exposed part must be insulated.

### HGM/HGE Type's Minimum Insulation Distance

Type	Minimum Clearance (mm)											
	460 V						240 V					
	A1	B1	B2	B3	C1	D1	A1	B1	B2	B3	C1	D1
HGM30 E/S	0	25	50	25	0	85	0	15	50	25	0	70
HGM50 E/S	0	25	50	25	0	85	0	15	50	25	0	70
HGM100 E/S/H/L	0	25	50	25	0	85	0	15	50	25	0	70
HGM50 H/L	0	25	50	25	0	85	0	15	50	25	0	70
HGM125 E/S/H/L	0	25	50	25	0	85	0	15	50	25	0	70
HGM160 E/S	0	25	80	40	0	140	0	15	80	40	0	110
HGM160 H/L	0	40	80	40	0	140	0	20	80	40	0	110
HGM250 E/S	0	25	80	40	0	140	0	15	80	40	0	110
HGM250 H/L	0	40	80	40	0	140	0	20	80	40	0	110
HGE30 E/S	0	25	50	25	0	85	0	15	50	25	0	70
HGE50 E/S	0	25	50	25	0	85	0	15	50	25	0	70
HGE100 E/S/H/L	0	25	50	25	0	85	0	15	50	25	0	70
HGE50 H/L	0	25	50	25	0	85	0	15	50	25	0	70
HGE125 E/S/H/L	0	25	50	25	0	85	0	15	50	25	0	70
HGE160 E/S	0	25	80	40	0	140	0	15	80	40	0	110
HGE160 H/L	0	40	80	40	0	140	0	20	80	40	0	110
HGE250 E/S	0	25	80	40	0	140	0	15	80	40	0	110
HGE250 H/L	0	40	80	40	0	140	0	20	80	40	0	110
HGM400 E/S	0	60	120	60	0	200	0	30	120	60	0	160
HGM400 H/L	0	80	120	60	0	200	0	40	120	60	0	160
HGM630, 800 E/S	0	60	120	60	0	200	0	30	120	60	0	160
HGM630, 800 H/L	0	80	120	60	0	200	0	40	120	60	0	160
HGE400 E/S	0	60	120	60	0	200	0	30	120	60	0	160
HGE400 H/L	0	80	120	60	0	200	0	40	120	60	0	160
HGE630, 800 E/S	0	60	120	60	0	200	0	30	120	60	0	160
HGE630, 800 H/L	0	80	120	60	0	200	0	40	120	60	0	160



### Installation Angle

It can be installed vertically or horizontally without changing any characteristics of the HGM/HGE Type of circuit breakers and as for the detailed installation direction, please refer to the figure below.

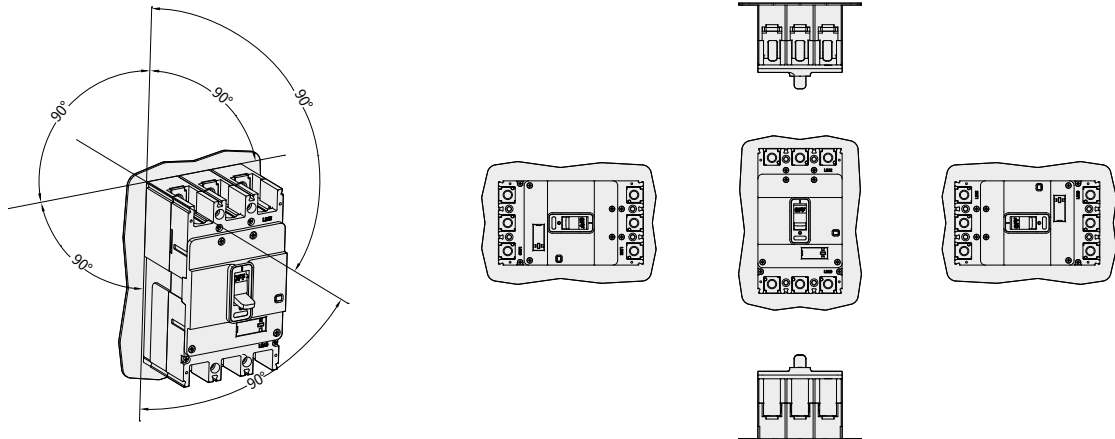

### Direction of Power Supply

#### HGM/HGE Type

When wiring the terminal between breakers, the LINE, LOAD mark in front of the product's cover must be checked.

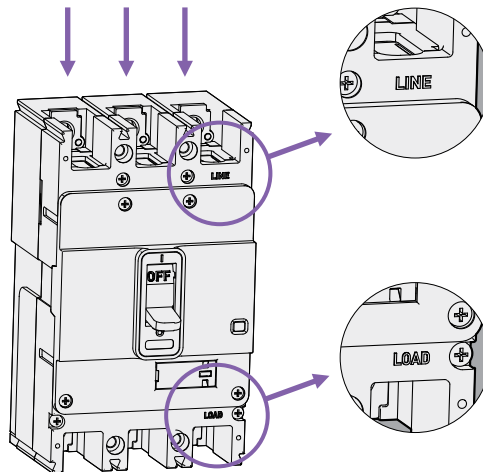





## Technical Data (HGM/HGE)

### Standard Configuration

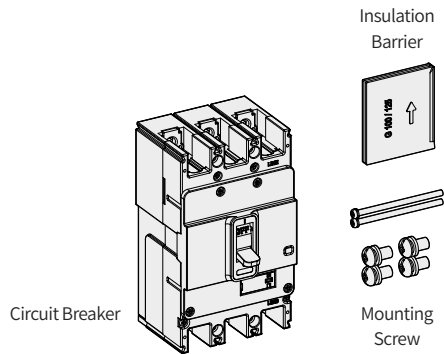
#### HGM/HGE Type

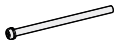



#### HGM/HGE30 ~ 250

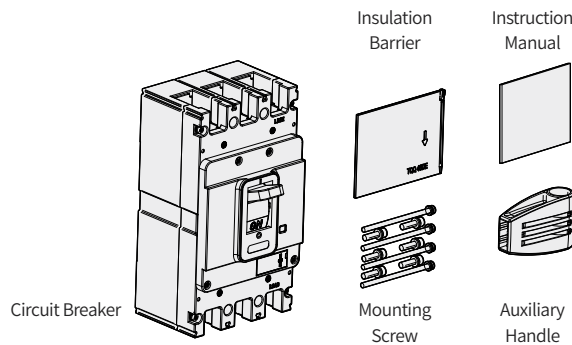

Type	Part					
HGM/HGE 30, 50E/S, 60, 100	2P	2 EA (M4×L70)	4 EA	(M5×L15) (15 ~ 50 A)	(M8×L15) (60 ~ 100 A)	1 EA
	3P	2 EA (M4×L70)	6 EA			2 EA
	4P	4 EA (M4×L70)	8 EA	3 EA		
HGM/HGE 50H/L, 125	2P	2 EA (M4×L70)	4 EA (M8×L15)		1 EA	
	3P	2 EA (M4×L70)	6 EA (M8×L15)		2 EA	
	4P	4 EA (M4×L70)	8 EA (M8×L15)		3 EA	
HGM/HGE 160, 250	2P	2 EA (M4×L70)	4 EA (Hex Socket M8×L18)		1 EA	
	3P	2 EA (M4×L70)	6 EA (Hex Socket M8×L18)		2 EA	
	4P	4 EA (M4×L70)	8 EA (Hex Socket M8×L18)		3 EA	

#### HGM/HGE400 ~ 800



Type	Part				
HGM/HGE 400	2P	4 EA (M6×L103)	4 EA (M10×L30)	1 EA	1 EA
	3P	4 EA (M6×L103)	6 EA (M10×L30)	2 EA	1 EA
	4P	6 EA (M6×L103)	8 EA (M10×L30)	3 EA	1 EA
HGM/HGE 630, 800	2P	4 EA (M6×L103)	4 EA (M12×L30)	1 EA	1 EA
	3P	4 EA (M6×L103)	6 EA (M12×L30)	2 EA	1 EA
	4P	6 EA (M6×L103)	8 EA (M12×L30)	3 EA	1 EA

## MCCB/ELCB Assembly and Terminal Mounting Specification

### HGM/HGE Type

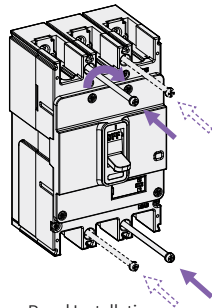

Panel Installation

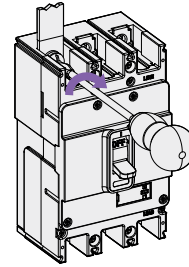

Terminal Connection

No	Type	Panel Mounting		Connection Terminal		
		Screw Specification	Terminal Connection Method and Dimensions (mm)	Conductor Processing	Tightening Torque	
1	HGM/HGE 30, 50E/S, 60, 100	M4 : 13 kgf.cm				M5 : 28.5 kgf.cm M8 : 110 kgf.cm
2	HGM/HGE 50H/L,125	M4 : 13 kgf.cm				M8 : 110 kgf.cm
3	HGM/HGE 160, 250	M4 : 13 kgf.cm				Hex M8 : 110 kgf.cm
4	HGM/HGE 400	M6 : 45 kgf.cm				Hex M10 : 270 kgf.cm
5	HGM/HGE 630, 800	M6 : 45 kgf.cm				Hex M12 : 470 kgf.cm

## Technical Data (HGP)

### Environmental Operating Conditions

#### Temperature Derating

The overcurrent characteristic of MCCB has been set to the ambient temperature of 40°C. If the ambient temperature is less or more than 40°C, the overcurrent characteristics may differ.

#### If the Ambient Temperature is less than 40 °C

In order to ensure that the circuit breaker’s overcurrent meet the derating curve at the given ambient temperature, the real current (Ir) has to be adjusted. The temperature correction ratio or each MCCB is shown in the circuit breaker’s characteristics curve.

#### If the Ambient Temperature is more than 40 °C

As the internal temperature of MCCB is a sum of increased temperature due to current flow and the ambient temperature, if the ambient temperature exceeds 40 °C, thermal damage of internal insulation material of MCCB may occur causing the circuit breaker to trip at an early stage. When applying ambient temperature higher than 40 °C, the rated current must be adjusted as shown in the following rated current derating table.

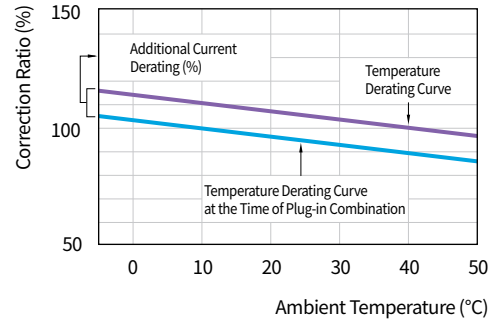

In (Rated Current) :  
Circuit breaker’s rating at ambient temperature of 40 °C  
Ir (Real Current) :  
Circuit breaker’s rating at the given temperature  
 $I_r = \text{Correction Ratio (\%)} \times I_n$

Rated Current Derating Table : HGP Type/Standard Mounting (Fixed Type)

Model	Rated Current (A)	Ambient Temperature (°C)									
		10	20	30	40	45	50	55	60	65	70
HGP160D	16	18	17	17	16	16	15	15	14	14	13
	20	22	22	21	20	19	19	18	18	17	16
	25	28	27	26	25	24	24	23	22	22	21
	32	36	35	33	32	31	30	29	28	27	26
	40	45	43	42	40	39	38	36	35	34	33
	50	56	54	52	50	49	47	46	44	43	41
	63	71	68	66	63	61	59	57	55	53	51
	80	90	87	83	80	78	75	73	70	68	65
	100	112	108	104	100	97	94	91	88	85	82
	125	141	135	130	125	121	117	113	109	105	101
HGP250	40	46	44	42	40	39	38	37	36	35	34
	50	58	55	53	50	49	48	46	45	44	43
	63	72	69	66	63	61	60	58	57	55	54
	80	92	88	84	80	78	76	74	72	70	68
	100	115	110	105	100	98	95	93	90	88	85
	125	144	138	131	125	122	119	116	113	109	106
	150	173	165	158	150	146	143	139	135	131	128
	160	184	176	168	160	156	152	148	144	140	136
	175	201	193	184	175	171	166	162	158	153	149
	200	230	220	210	200	195	190	185	180	175	170
HGP400 HGP630	225	259	248	236	225	219	214	208	203	197	191
	250	288	275	263	250	244	238	231	225	219	213
	300	323	315	308	300	291	282	273	264	255	246
	350	376	368	359	350	340	330	320	310	300	290
	400	430	420	410	400	388	376	364	352	340	328
HGP800	500	538	525	513	500	485	470	455	440	425	410
	630	677	662	646	630	611	592	573	554	535	516
	700	753	735	718	700	679	658	637	616	595	574
	800	860	840	820	800	776	752	728	704	680	656

Rated Current Derating Table : HGP Type/Plug-in Method

Model	Rated Current(A)	Ambient Temperature (°C)									
		10	20	30	40	45	50	55	60	65	70
HGP 160D	16	16	16	15	14	14	14	13	13	12	12
	20	20	19	19	18	17	17	16	16	15	15
	25	25	24	23	23	22	21	21	20	19	19
	32	32	31	30	29	28	27	26	25	24	23
	40	40	39	37	36	35	34	33	32	31	30
	50	51	49	47	45	44	42	41	40	38	37
	63	64	61	59	57	55	53	51	50	48	46
	80	81	78	75	72	70	68	65	63	61	59
	100	101	97	94	90	87	85	82	79	77	74
	125	126	122	117	113	109	105	102	98	95	91
	150	152	146	140	135	131	126	122	117	113	108
160	162	156	150	144	140	135	131	126	122	117	
HGP250	40	40	38	36	34	33	32	31	30	29	28
	50	50	48	45	43	41	40	39	38	36	35
	63	63	60	57	54	52	50	49	47	46	44
	80	80	76	72	68	66	64	62	60	58	56
	100	105	100	95	90	88	85	83	80	78	75
	125	131	125	119	113	109	106	103	100	97	94
	150	158	150	143	135	131	128	124	120	116	113
	160	168	160	152	144	140	136	132	128	124	120
	175	184	175	166	158	153	149	144	140	136	131
	200	210	200	190	180	175	170	165	160	155	150
	225	236	225	214	203	197	191	186	180	174	169
250	263	250	238	225	219	213	206	200	194	188	
HGP400 HGP630	300	284	277	271	264	256	248	240	232	224	216
	350	331	323	316	308	299	290	282	273	264	255
	400	378	370	361	352	341	331	320	310	299	289
	500	473	462	451	440	427	414	400	387	374	361
HGP800	630	596	582	568	554	538	521	504	488	471	454
	700	696	680	664	648	628	609	589	570	550	531
	800	796	777	759	740	718	696	673	651	629	607

## Technical Data (HGP)

### Environmental Operating Conditions

#### Altitude Derating

The characteristics of the circuit breaker is not affected at an altitude of less than 2,000 m Characteristics of insulation and air cooling of the circuit breaker are reduced at an altitude of more than 2,000 m and the rated current and rated voltage must be adjusted as shown in the table below. However, there is no change in the characteristics of breaking capacity.

Circuit breaker	Altitude	2,000 m	3,000 m	4,000 m	5,000 m
HGP Type MCCB HGP160D HGP250 ~ 800	Withstand Voltage (V)	3,000	2,500	2,100	1,800
	Insulation Voltage (V) $U_i$	1,000	850	750	650
	Maximum Operational Voltage (V) $U_e$	690	590	520	460
	Average Through-Current (A), at 40 °C $I_n \times$	1	0.96	0.93	0.9

#### Vibrations

The excessive vibration may cause problems such as decrease of breaking capacity, lower dynamic, strength, reduction of electric current conductivity or compromising safety of operating characteristics. Therefore, proper consideration is required with regards to these environmental stresses when it comes to designating the circuit breakers. These stresses are generated by the vibration during transportation, magnetic impact during opening and closing operation and influence of adjacent devices. Our circuit breaker has been verified in accordance with the standards with regards to vibration resistance.

#### Vibration Test

Vibration test is verified with the standard requested by the shipping certification institute in compliance with IEC 60068-2-6. Out of the vibration test items, resonance test and vibration Endurance test were verified based on the following standard.

#### Vibration Endurance Test

A sinusoidal wave with frequency of 30 Hz is applied for 90 minutes to check for abnormalities.

- 30 Hz : 0.7 g Acceleration

#### Resonance Test

It confirms whether vibration is generated in the characteristics part of MCCB by slowly changing the frequency in the frequency sector of the following sinusoidal wave.

- 5 ~ 13.2 Hz : 1 mm Displacement
- 13.2 ~ 100 Hz : 0.7 g Acceleration

### Seismic Performance and Shock Tolerance Table

Item	Seismic
Test Condition Mounting Posture Direction of Vibration, Shock	<ul style="list-style-type: none"> <li>• Vertical mounting</li> <li>• Up-down, left-right, front-back</li> </ul>
Test Result Status of MCCB Judgment Condition	<ul style="list-style-type: none"> <li>• Non-conduction (ON or OFF status)</li> <li>• Status where rated current has been conducted on until the temperature of MCCB becomes constant and continuous</li> </ul> <ul style="list-style-type: none"> <li>• If it is ON, it should not turn OFF</li> <li>• If it is OFF, it should not turn ON</li> <li>• No abnormal status such as damage, deformation or loosened screw part</li> <li>• The characteristics of switch and trip after the test must be normal</li> </ul>

## Degree of Protection

The MCCB's IP rating is defined based on IEC 60529. The IP rating also depends on product conditions.

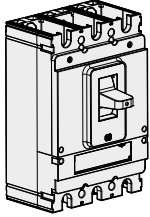
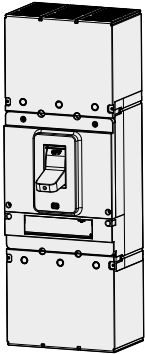
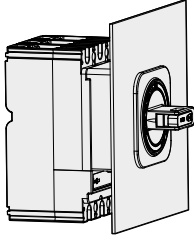
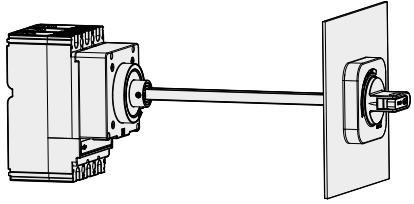
Condition	Circuit Breaker	Circuit Breaker + Terminal Cover	Circuit Breaker + Terminal Cover + Rotary Handle (Front Contact Type)	Circuit Breaker + Terminal Cover + Rotary Handle (Extension Type)
Appearance				
Protection Degree	IP20	IP40	IP40	IP40/IP54

※ 1) When applying IP54, please contact us separately.

# Technical Data (HGP)

## Power Loss / Resistance

### HGP Type MCCB

Type	Rated Current (A)	HGP50D		HGP125D		HGP160D		HGP100		HGP160		HGP250	
		R/Pole (mΩ)	P/Pole (W)	R/Pole (mΩ)	P/Pole (W)	R/Pole (mΩ)	P/Pole (W)	R/Pole (mΩ)	P/Pole (W)	R/Pole (mΩ)	P/Pole (W)	R/Pole (mΩ)	P/Pole (W)
Fixed 	16	14.4	3.69	14.4	3.69	14.4	3.69						
	20	14.4	5.76	14.4	5.76	14.4	5.76						
	25	6.372	3.98	6.372	3.98	6.372	3.98						
	32	4.056	4.15	4.056	4.15	4.056	4.15						
	40	2.544	4.07	2.544	4.07	2.544	4.07	2.40	3.84				
	50	2.544	6.36	2.544	6.36	2.544	6.36	1.80	4.50				
	63			1.488	5.91	1.488	5.91	1.30	5.16				
	80			1.188	7.60	1.188	7.60	0.84	5.37				
	100			1.044	10.44	1.044	10.44	0.88	8.80	0.88	8.80		
	125			0.924	14.44	0.924	14.44			0.61	9.53	0.61	9.53
	150					0.792	17.82			0.46	10.35	0.46	10.35
	160					0.792	20.28			0.46	11.78	0.46	11.78
	175											0.39	11.94
	200											0.39	15.60
	225											0.3	15.19
250											0.3	18.75	

Type	Rated Current (A)	HGP400		HGP630		HGP800	
		R/Pole (mΩ)	P/Pole (W)	R/Pole (mΩ)	P/Pole (W)	R/Pole (mΩ)	P/Pole (W)
Fixed 	300	0.215	19.35				
	350	0.215	26.34				
	400	0.185	29.60				
	500			0.155	38.75		
	630			0.125	49.61		
	700					0.11	53.90
	800					0.08	51.20

Type	Rated Current (A)	HGP100 MP	
		R/Pole (mΩ)	P/Pole (W)
Fixed 	2.5	160.7	1
	3.2	67.20	0.69
	6.3	14.85	0.59
	12.5	4.29	0.67
	20	2.53	1.01
	32	0.96	0.98
	50	0.59	1.49
	63	0.59	2.35
	80	0.52	3.34
	100	0.48	4.78

Type	Rated Current (A)	HGP100 ETU		HGP160 ETU		HGP250 ETU		HGP400 ETU		HGP630 ETU		HGP800 ETU	
		R/Pole (mΩ)	P/Pole (W)	R/Pole (mΩ)	P/Pole (W)	R/Pole (mΩ)	P/Pole (W)	R/Pole (mΩ)	P/Pole (W)	R/Pole (mΩ)	P/Pole (W)	R/Pole (mΩ)	P/Pole (W)
Fixed 	40	0.6	0.96										
	100	0.3	3.00	0.3	3.00								
	160			0.3	7.68	0.3	7.68						
	250					0.3	18.75	0.125	7.81				
	400							0.125	20.00				
	630									0.125	49.61		
	800											0.08	51.20



Type	Rated Current (A)	HGP50D		HGP125D		HGP160D		HGP100		HGP160		HGP250		
		R/Pole (mΩ)	P/Pole (W)	R/Pole (mΩ)	P/Pole (W)	R/Pole (mΩ)	P/Pole (W)	R/Pole (mΩ)	P/Pole (W)	R/Pole (mΩ)	P/Pole (W)	R/Pole (mΩ)	P/Pole (W)	
Plug-in 	16	14.48	3.71	14.48	3.71	14.48	3.71							
	20	14.48	5.79	14.48	5.79	14.48	5.79							
	25	6.452	4.03	6.452	4.03	6.452	4.03							
	32	4.136	4.24	4.136	4.24	4.136	4.24							
	40	2.624	4.20	2.624	4.20	2.624	4.20	2.46	3.94					
	50	2.624	6.56	2.624	6.56	2.624	6.56	1.86	4.65					
	63			1.568	6.22	1.568	6.22	1.36	5.40					
	80			1.268	8.12	1.268	8.12	0.899	5.75					
	100			1.124	11.24	1.124	11.24	0.94	9.40	0.94	9.40			
	125			1.004	15.69	1.004	15.69			0.67	10.47	0.67	10.47	
	150							0.872	19.62		0.52	11.70	0.52	11.70
	160							0.872	22.32		0.52	13.31	0.52	13.31
	175											0.45	13.78	
	200											0.45	18.00	
	225											0.36	18.23	
250											0.36	22.50		

Type	Rated Current (A)	HGP400		HGP630		HGP800	
		R/Pole (mΩ)	P/Pole (W)	R/Pole (mΩ)	P/Pole (W)	R/Pole (mΩ)	P/Pole (W)
Plug-in 	300	0.255	22.95				
	350	0.255	31.24				
	400	0.225	36.00				
	500			0.195	48.75		
	630			0.165	65.49		
	700					0.13	63.70
	800					0.1	64.00

Type	Rated Current (A)	HGP100 MP	
		R/Pole (mΩ)	P/Pole (W)
Plug-in 	2.5	160.76	1
	3.2	67.26	0.69
	6.3	14.91	0.59
	12.5	4.35	0.68
	20	2.59	1.04
	32	1.015	1.04
	50	0.654	1.64
	63	0.651	2.58
	80	0.582	3.72
	100	0.538	5.38

Type	Rated Current (A)	HGP100 ETU		HGP160 ETU		HGP250 ETU		HGP400 ETU		HGP630 ETU		HGP800 ETU	
		R/Pole (mΩ)	P/Pole (W)	R/Pole (mΩ)	P/Pole (W)	R/Pole (mΩ)	P/Pole (W)	R/Pole (mΩ)	P/Pole (W)	R/Pole (mΩ)	P/Pole (W)	R/Pole (mΩ)	P/Pole (W)
Plug-in 	40	0.66	1.06										
	100	0.36	3.60	0.36	3.60								
	160			0.36	9.22	0.36	9.22						
	250					0.36	22.50	0.165	10.31				
	400							0.165	26.40				
	630									0.165	65.49		
	800											0.1	64.00

# Technical Data (HGP)

## Cascading Table

### AC 220/240 V

Upstream : HGP50D, HGP125D, HGP160D, HGP250, HGP400, HGP630

Downstream : HGD32\*, HGD63\*, HGD125\*, HGM30, HGM50

Upstream Circuit Breaker	HGP50D				HGP125D				HGP160D			
	F*	S	H	X	F*	S	H	X	F*	S	H	X
Breaking Capacity [Icu] (kA r.m.s.)	65	100	130	200	65	100	130	200	65	100	130	200
Downstream Breaking Capacity [Icu] (kA r.m.s.)	Enhanced Breaking Capacity											
HGD63E*	10	20	20	20	20	20	20	20	20	20	20	20
HGD63S*	15	30	30	30	30	30	30	30	30	30	30	30
HGD32NS*, HGD63N/M*	20	40	60	60	60	60	60	60	60	60	60	60
HGD63H/P*	25	40	60	60	60	60	60	60	40	60	60	60
HGD100S/125*	25	40	60	60	60	60	60	60	40	60	60	60

Upstream Circuit Breaker	HGP100				HGP160				HGP250			
	F*	S	H	X	F*	S	H	X	F*	S	H	X
Breaking Capacity [Icu] (kA r.m.s.)	65	100	130	200	65	100	130	200	65	100	130	200
Downstream Breaking Capacity [Icu] (kA r.m.s.)	Enhanced Breaking Capacity											
HGD63E*	10	20	20	20	20	20	20	20	20	20	20	20
HGD63S*	15	30	30	30	30	30	30	30	30	30	30	30
HGD32NS*, HGD63N/M*	20	40	60	60	60	60	60	60	40	60	60	60
HGD63H/P*	25	40	60	60	60	60	60	60	40	60	60	60
HGD100S/125*	25	40	60	60	60	60	60	60	40	60	60	60

Upstream Circuit Breaker	HGP50D				HGP125D				HGP160D			
	F*	S	H	X	F*	S	H	X	F*	S	H	X
Breaking Capacity [Icu] (kA r.m.s.)	65	100	130	200	65	100	130	200	65	100	130	200
Downstream Breaking Capacity [Icu] (kA r.m.s.)	Enhanced Breaking Capacity											
HGM30E	35	65	70	70	70	65	70	70	70	65	70	70
HGM30S	50	65	70	70	70	65	70	70	70	65	70	70
HGM50E	35	65	85	100	100	65	85	100	100	65	85	100
HGM50S	50	65	100	130	130	65	100	130	130	65	100	130
HGM50H	85		100	130	150		100	130	150		100	130
HGM50L	100			130	150			130	150			130

Upstream Circuit Breaker	HGP100				HGP160			
	F*	S	H	X	F*	S	H	X
Breaking Capacity [Icu] (kA r.m.s.)	65	100	130	200	65	100	130	200
Downstream Breaking Capacity [Icu] (kA r.m.s.)	Enhanced Breaking Capacity							
HGM30E	35	65	70	70	70	65	70	70
HGM30S	50	65	70	70	70	65	70	70
HGM50E	35	65	85	100	100	65	85	100
HGM50S	50	65	100	130	130	65	100	130
HGM50H	85		100	130	150		100	130
HGM50L	100			130	150			130

Upstream Circuit Breaker	HGP250				HGP400				HGP630			
	F*	S	H	X	F*	S	H	X	F*	S	H	X
Breaking Capacity [Icu] (kA r.m.s.)	65	100	130	200	65	100	130	200	65	100	130	200
Downstream Breaking Capacity [Icu] (kA r.m.s.)	Enhanced Breaking Capacity											
HGM30E	35	65	70	70	70	65	70	70	70	65	70	70
HGM30S	50	65	70	70	70	65	70	70	70	65	70	70
HGM50E	35	65	85	100	100	65	85	100	100	65	85	100
HGM50S	50	65	100	130	130	65	100	130	130	65	100	130
HGM50H	85		100	130	150		100	130	150		100	130
HGM50L	100			130	150			130	150			130

※ \* F type is for overseas sales.

Upstream : HGP125D, HGP160D, HGP250, HGP400, HGP630

Downstream : HGM60, HGM100, HGM125, HGM160, HGM250

Upstream Circuit Breaker		HGP125D				HGP160D				HGP100			
		F*	S	H	X	F*	S	H	X	F*	S	H	X
Breaking Capacity [Icu] (kA r.m.s.)		65	100	130	200	65	100	130	200	65	100	130	200
Downstream Breaking Capacity [Icu] (kA r.m.s.)		Enhanced Breaking Capacity											
HGM60E	35	65	70	70	70	65	70	70	70	65	70	70	70
HGM60S	50	65	70	70	70	65	70	70	70	65	70	70	70
HGM60H	50	65	70	70	70	65	70	70	70	65	70	70	70
HGM60L	50	65	70	70	70	65	70	70	70	65	70	70	70
HGM100E	35	65	70	70	70	65	70	70	70	65	70	70	70
HGM100S	50	65	70	70	70	65	70	70	70	65	70	70	70
HGM100H	50	65	70	70	70	65	70	70	70	65	70	70	70
HGM100L	50	65	70	70	70	65	70	70	70	65	70	70	70
HGM125E	50	65	85	100	100	65	85	100	100				
HGM125S	65		100	130	130		100	130	130				
HGM125H	85		100	130	150		100	130	150				
HGM125L	100			130	150			130	150				

Upstream Circuit Breaker		HGP160				HGP250				HGP400				HGP630			
		F*	S	H	X	F*	S	H	X	F*	S	H	X	F*	S	H	X
Breaking Capacity [Icu] (kA r.m.s.)		65	100	130	200	65	100	130	200	65	100	130	200	65	100	130	200
Downstream Breaking Capacity [Icu] (kA r.m.s.)		Enhanced Breaking Capacity															
HGM60E	35	65	70	70	70	65	70	70	70	65	70	70	70	65	70	70	70
HGM60S	50	65	70	70	70	65	70	70	70	65	70	70	70	65	70	70	70
HGM60H	50	65	70	70	70	65	70	70	70	65	70	70	70	65	70	70	70
HGM60L	50	65	70	70	70	65	70	70	70	65	70	70	70	65	70	70	70
HGM100E	35	65	70	70	70	65	70	70	70	65	70	70	70	65	70	70	70
HGM100S	50	65	70	70	70	65	70	70	70	65	70	70	70	65	70	70	70
HGM100H	50	65	70	70	70	65	70	70	70	65	70	70	70	65	70	70	70
HGM100L	50	65	70	70	70	65	70	70	70	65	70	70	70	65	70	70	70
HGM125E	50	65	85	100	100	65	85	100	100	65	85	100	100	65	85	100	100
HGM125S	65		100	130	130		100	130	130		100	130	130		100	130	130
HGM125H	85		100	130	150		100	130	150		100	130	150		100	130	150
HGM125L	100			130	150			130	150			130	150			130	150

Upstream Circuit Breaker		HGP160D				HGP160				HGP250			
		F*	S	H	X	F*	S	H	X	F*	S	H	X
Breaking Capacity [Icu] (kA r.m.s.)		65	100	130	200	65	100	130	200	65	100	130	200
Downstream Breaking Capacity [Icu] (kA r.m.s.)		Enhanced Breaking Capacity											
HGM160E	50	65	85	100	100	65	85	100	100	65	85	100	100
HGM160S	65		100	130	130		100	130	130		100	130	130
HGM160H	85		100	130	150		100	130	150		100	130	150
HGM160L	100			130	150			130	150			130	150
HGM250E	50									65	85	100	100
HGM250S	65										100	130	130
HGM250H	85										100	130	150
HGM250L	100											130	150

※ \* F type is for overseas sales.

## Technical Data (HGP)

### Cascading Table

#### AC 220/240 V

Upstream : HGP400, HGP630, HGP800

Downstream : HGM160, HGM250, HGM400, HGM600, HGM800

Upstream Circuit Breaker		HGP400				HGP630				HGP800			
		F*	S	H	X	F*	S	H	X	F*	S	H	X
Breaking Capacity [Icu] (kA r.m.s.)		65	100	130	200	65	100	130	200	65	100	130	200
Downstream Breaking Capacity [Icu] (kA r.m.s.)		Enhanced Breaking Capacity											
HGM160E	50	65	85	100	100	65	85	100	100				
HGM160S	65		100	130	130		100	130	130				
HGM160H	85		100	130	150		100	130	150				
HGM160L	100			130	150			130	150				
HGM250E	50	65	85	100	100	65	85	100	100	65	85	100	100
HGM250S	65		100	130	130		100	130	130		100	130	130
HGM250H	85		100	130	150		100	130	150		100	130	150
HGM250L	100			130	150			130	150			130	150

Upstream Circuit Breaker		HGP400				HGP630				HGP800			
		F*	S	H	X	F*	S	H	X	F*	S	H	X
Breaking Capacity [Icu] (kA r.m.s.)		65	100	130	200	65	100	130	200	65	100	130	200
Downstream Breaking Capacity [Icu] (kA r.m.s.)		Enhanced Breaking Capacity											
HGM400E	50	65	100	130	150	65	100	130	150	65	100	130	150
HGM400S	75		100	130	150		100	130	150		100	130	150
HGM400H	100			130	200			130	200			130	200
HGM400L	125			130	200			130	200			130	200
HGM600E	50					65	100	130	150	65	100	130	150
HGM600S	75						100	130	150		100	130	150
HGM600H	100							130	200			130	200
HGM600L	125							130	200			130	200
HGM800S	75										100	130	150
HGM800H	100											130	200
HGM800L	125											130	200

※ \* F type is for overseas sales.

Upstream : HGP50D, HGP125D, HGP160D, HGP250, HGP400, HGP630, HGP800

Downstream : HGP50D, HGP125D, HGP160D, HGP250, HGP400, HGP630, HGP800

Upstream Circuit Breaker	HGP50D				HGP125D				HGP160D			
	F*	S	H	X	F*	S	H	X	F*	S	H	X
Breaking Capacity [Icu] (kA r.m.s.)	65	100	130	200	65	100	130	200	65	100	130	200
Downstream Breaking Capacity [Icu] (kA r.m.s.)	Enhanced Breaking Capacity											
HGP50D/125D/160D F*	65	100	130	150		100	130	150		100	130	150
HGP50D/125D/160D S	100		130	200			130	200			130	200
HGP50D/125D/160D H	130			200				200				200

Upstream Circuit Breaker	HGP100				HGP160				HGP250			
	F*	S	H	X	F*	S	H	X	F*	S	H	X
Breaking Capacity [Icu] (kA r.m.s.)	65	100	130	200	65	100	130	200	65	100	130	200
Downstream Breaking Capacity [Icu] (kA r.m.s.)	Enhanced Breaking Capacity											
HGP50D F*	65	100	130	150		100	130	150		100	130	150
HGP50D S	100		130	200			130	200			130	200
HGP50D H	130			200				200				200
HGP125D F*	65	100	130	150		100	130	150		100	130	150
HGP125D S	100		130	200			130	200			130	200
HGP125D H	130			200				200				200
HGP160D F*	65	100	130	150		100	130	150		100	130	150
HGP160D S	100		130	200			130	200			130	200
HGP160D H	130			200				200				200
HGP100 F*	65	100	130	150		100	130	150		100	130	150
HGP100 S	100		130	200			130	200			130	200
HGP100 H	130			200				200				200
HGP160 F*	65					100	130	150		100	130	150
HGP160 S	100						130	200			130	200
HGP160 H	130							200				200
HGP250 F*	65									100	130	150
HGP250 S	100										130	200
HGP250 H	130											200

Upstream Circuit Breaker	HGP400				HGP630				HGP800			
	F*	S	H	X	F*	S	H	X	F*	S	H	X
Breaking Capacity [Icu] (kA r.m.s.)	65	100	130	200	65	100	130	200	65	100	130	200
Downstream Breaking Capacity [Icu] (kA r.m.s.)	Enhanced Breaking Capacity											
HGP50D/125D/160DF*	65	100	130	150		100	130	150		100	130	150
HGP50D/125D/160DS	100		130	200			130	200			130	200
HGP50D/125D/160DH	130			200				200				200
HGP100 F*	65	100	130	150		100	130	150		100	130	150
HGP100 S	100		130	200			130	200			130	200
HGP100 H	130			200				200				200
HGP160 F*	65	100	130	150		100	130	150		100	130	150
HGP160 S	100		130	200			130	200			130	200
HGP160 H	130			200				200				200
HGP250 F*	65	100	130	150		100	130	150		100	130	150
HGP250 S	100		130	200			130	200			130	200
HGP250 H	130			200				200				200
HGP400/630 F*	65	100	130	150		100	130	150		100	130	150
HGP400/630 S	100		130	200			130	200			130	200
HGP400/630 H	130			200				200				200
HGP800 F*	65									100	130	150
HGP800 S	100										130	200
HGP800 H	130											200

※ \* F type is for overseas sales.

# Technical Data (HGP)

## Cascading Table

### AC 440/460 V

Upstream : HGP50D, HGP125D, HGP160D, HGP250, HGP400, HGP630

Downstream : HGD32\*, HGD63\*, HGD125\*, HGM30, HGM50

Upstream Circuit Breaker	HGP50D				HGP125D				HGP160D				
	F*	S	H	X	F*	S	H	X	F*	S	H	X	
Breaking Capacity [Icu] (kA r.m.s.)	36	65	85	150	36	65	85	150	36	65	85	150	
Downstream Breaking Capacity [Icu] (kA r.m.s.)	Enhanced Breaking Capacity												
HGD63E*	3	10	15	15	15	10	15	15	15	10	15	15	15
HGD63S*	4.5	14	15	20	20	15	20	20	20	15	20	20	20
HGD32NS*, HGD63N/M*	6	20	26	26	26	20	26	26	26	20	26	26	26
HGD63H/P*	10	20	30	30	30	20	30	30	30	20	30	30	30
HGD100S/125*	10	20	30	30	30	20	30	30	30	20	30	30	30

Upstream Circuit Breaker	HGP100				HGP160				HGP250				
	F*	S	H	X	F*	S	H	X	F*	S	H	X	
Breaking Capacity [Icu] (kA r.m.s.)	36	65	85	150	36	65	85	150	36	65	85	150	
Downstream Breaking Capacity [Icu] (kA r.m.s.)	Enhanced Breaking Capacity												
HGD63E*	3	10	15	15	15	10	15	15	15	10	15	15	15
HGD63S*	4.5	15	20	20	20	15	20	20	20	15	20	20	20
HGD32NS*, HGD63N/M*	6	20	26	26	26	20	26	26	26	20	26	26	26
HGD63H/P*	10	20	30	30	30	20	30	30	30	20	30	30	30
HGD100S/125*	10	20	30	30	30	20	30	30	30	20	30	30	30

Upstream Circuit Breaker	HGP50D				HGP125D				HGP160D				
	F*	S	H	X	F*	S	H	X	F*	S	H	X	
Breaking Capacity [Icu] (kA r.m.s.)	36	65	85	150	36	65	85	150	36	65	85	150	
Downstream Breaking Capacity [Icu] (kA r.m.s.)	Enhanced Breaking Capacity												
HGM30 E	16	26	38	38	38	26	38	38	38	26	38	38	38
HGM30 S	20	30	38	38	38	30	38	38	38	30	38	38	38
HGM50 E	16	26	38	38	38	26	38	38	38	26	38	38	38
HGM50 S	20	30	38	38	38	30	38	38	38	30	38	38	38
HGM50 H	38		50	70	85		50	70	85		50	70	85
HGM50 L	55		65	70	85		65	70	85		65	70	85

Upstream Circuit Breaker	HGP100				HGP160			
	F*	S	H	X	F*	S	H	X
Breaking Capacity [Icu] (kA r.m.s.)	36	65	85	150	36	70	85	150
Downstream Breaking Capacity [Icu] (kA r.m.s.)	Enhanced Breaking Capacity							
HGM30 E	16	26	38	38	38	26	38	38
HGM30 S	20	30	38	38	38	30	38	38
HGM50 E	16	26	38	38	38	26	38	38
HGM50 S	20	30	38	38	38	30	38	38
HGM50 H	38		50	70	85		50	70
HGM50 L	55		65	70	85		65	70

Upstream Circuit Breaker	HGP250				HGP400				HGP630				
	F*	S	H	X	F*	S	H	X	F*	S	H	X	
Breaking Capacity [Icu] (kA r.m.s.)	36	65	85	150	36	70	85	150	36	70	85	150	
Downstream Breaking Capacity [Icu] (kA r.m.s.)	Enhanced Breaking Capacity												
HGM30 E	16	26	38	38	38	26	38	38	38	26	38	38	38
HGM30 S	20	30	38	38	38	30	38	38	38	30	38	38	38
HGM50 E	16	26	38	38	38	26	38	38	38	26	38	38	38
HGM50 S	20	30	38	38	38	30	38	38	38	30	38	38	38
HGM50 H	38		50	70	85		50	70	85		50	70	85
HGM50 L	55		65	70	85		65	70	85		65	70	85

※ \* F type is for overseas sales.

Upstream : HGP125D, HGP160D, HGP250, HGP400, HGP630

Downstream : HGM60, HGM100, HGM125, HGM160, HGM250

Upstream Circuit Breaker	HGP125D				HGP160D				HGP100				
	F*	S	H	X	F*	S	H	X	F*	S	H	X	
Breaking Capacity [Icu] (kA r.m.s.)	36	65	85	150	36	65	85	150	36	65	85	150	
Downstream Breaking Capacity [Icu] (kA r.m.s.)	Enhanced Breaking Capacity												
HGM60 E	16	26	38	38	38	26	38	38	38	26	38	38	38
HGM60 S	20	30	38	38	38	30	38	38	38	30	38	38	38
HGM60 H	26	36	50	50	55	36	50	50	55	36	50	50	55
HGM60 L	30	36	50	50	55	36	50	50	55	36	50	50	55
HGM100 E	16	26	38	38	38	26	38	38	38	26	38	38	38
HGM100 S	20	30	38	38	38	30	38	38	38	30	38	38	38
HGM100 H	26	36	50	50	55	36	50	50	55	36	50	50	55
HGM100 L	30	36	50	50	55	36	50	50	55	36	50	50	55
HGM125 E	20	36	50	50	50	36	50	50	50				
HGM125 S	26	36	50	50	50	36	50	50	50				
HGM125 H	38		50	70	85		50	70	85				
HGM125 L	55		65	70	85		65	70	85				

Upstream Circuit Breaker	HGP160				HGP250				HGP400				HGP630				
	F*	S	H	X	F*	S	H	X	F*	S	H	X	F*	S	H	X	
Breaking Capacity [Icu] (kA r.m.s.)	36	65	85	150	36	65	85	150	36	70	85	150	36	70	85	150	
Downstream Breaking Capacity [Icu] (kA r.m.s.)	Enhanced Breaking Capacity																
HGM60 E	16	26	38	38	38	26	38	38	38	26	38	38	38	26	38	38	38
HGM60 S	20	30	38	38	38	30	38	38	38	30	38	38	38	30	38	38	38
HGM60 H	26	36	50	50	55	36	50	50	55	36	50	50	55	36	50	50	55
HGM60 L	30	36	50	50	55	36	50	50	55	36	50	50	55	36	50	50	55
HGM100 E	16	26	38	38	38	26	38	38	38	26	38	38	38	26	38	38	38
HGM100 S	20	30	38	38	38	30	38	38	38	30	38	38	38	30	38	38	38
HGM100 H	26	36	50	50	55	36	50	50	55	36	50	50	55	36	50	50	55
HGM100 L	30	36	50	50	55	36	50	50	55	36	50	50	55	36	50	50	55
HGM125 E	20	36	50	50	50	36	50	50	50	36	50	50	50	36	50	50	50
HGM125 S	26	36	50	50	50	36	50	50	50	36	50	50	50	36	50	50	50
HGM125 H	38		50	70	85		50	70	85		50	70	85		50	70	85
HGM125 L	55		65	70	85		65	70	85		65	70	85		65	70	85

Upstream Circuit Breaker	HGP160D				HGP100				HGP160				HGP250				
	F*	S	H	X	F*	S	H	X	F*	S	H	X	F*	S	H	X	
Breaking Capacity [Icu] (kA r.m.s.)	36	65	85	150	36	65	85	150	36	65	85	150	36	65	85	150	
Downstream Breaking Capacity [Icu] (kA r.m.s.)	Enhanced Breaking Capacity																
HGM160 E	20	36	50	50	50					36	50	50	50	36	50	50	50
HGM160 S	26	36	50	50	50					36	50	50	50	36	50	50	50
HGM160 H	38		50	70	85						50	70	85		50	70	85
HGM160 L	55		65	70	85						65	70	85		65	70	85
HGM250 E	20													36	50	50	50
HGM250 S	26													36	50	50	50
HGM250 H	38														50	70	85
HGM250 L	55														65	70	85

※ \* F type is for overseas sales.

## Technical Data (HGP)

### Cascading Table

#### AC 440/460 V

Upstream : HGP400, HGP630, HGP800

Downstream : HGM160, HGM250, HGM400, HGM600, HGM800

Upstream Circuit Breaker		HGP400				HGP630				HGP800			
		F*	S	H	X	F*	S	H	X	F*	S	H	X
Breaking Capacity [Icu] (kA r.m.s.)		36	70	85	150	36	70	85	150	36	70	85	150
Downstream Breaking Capacity [Icu] (kA r.m.s.)		Enhanced Breaking Capacity											
HGM160 E	20	36	50	50	50	36	50	50	50				
HGM160 S	26	36	50	50	50	36	50	50	50				
HGM160 H	38		50	70	85		50	70	85				
HGM160 L	55		65	70	85		65	70	85				
HGM250 E	20	36	50	50	50	36	50	50	50	36	50	50	50
HGM250 S	26	36	50	50	50	36	50	50	50	36	50	50	50
HGM250 H	38		50	70	85		50	70	85		50	70	85
HGM250 L	55		65	70	85		65	70	85		65	70	85

Upstream Circuit Breaker		HGP400				HGP630				HGP800			
		F*	S	H	X	F*	S	H	X	F*	S	H	X
Breaking Capacity [Icu] (kA r.m.s.)		36	70	85	150	36	70	85	150	36	70	85	150
Downstream Breaking Capacity [Icu] (kA r.m.s.)		Enhanced Breaking Capacity											
HGM400 E	38		70	85	100		70	85	100		70	85	85
HGM400 S	50		70	85	100		70	85	100		70	85	85
HGM400 H	70			85	100			85	100			85	100
HGM400 L	85				100				100				100
HGM600 E	38						70	85	100		70	85	85
HGM600 S	50						70	85	100		70	85	85
HGM600 H	70							85	100			85	100
HGM600 L	85								100				100
HGM800 S	50										70	85	85
HGM800 H	70											85	100
HGM800 L	85												100

※ \* F type is for overseas sales.



Upstream : HGP50D, HGP125D, HGP160D, HGP250, HGP400, HGP630, HGP800

Downstream : HGP50D, HGP125D, HGP160D, HGP250, HGP400, HGP630, HGP800

Upstream Circuit Breaker	HGP50D				HGP125D				HGP160D			
	F*	S	H	X	F*	S	H	X	F*	S	H	X
Breaking Capacity [Icu] (kA r.m.s.)	36	65	85	150	36	65	85	150	36	65	85	150
Downstream Breaking Capacity [Icu] (kA r.m.s.)	Enhanced Breaking Capacity											
HGP50D/125D/160D F*	38	65	85	100		65	85	100		65	85	100
HGP50D/125D/160D S	70		85	150			85	150			85	150
HGP50D/125D/160D H	85			150				150				150

Upstream Circuit Breaker	HGP100				HGP160				HGP250			
	F*	S	H	X	F*	S	H	X	F*	S	H	X
Breaking Capacity [Icu] (kA r.m.s.)	36	65	85	150	36	65	85	150	36	65	85	150
Downstream Breaking Capacity [Icu] (kA r.m.s.)	Enhanced Breaking Capacity											
HGP50D F*	36	65	85	100		65	85	100		65	85	100
HGP50D S	65		85	150			85	150			85	150
HGP50D H	85			150				150				150
HGP125D F*	36					65	85	100		65	85	100
HGP125D S	65						85	150			85	150
HGP125D H	85							150				150
HGP160D F*	36					65	85	100		65	85	100
HGP160D S	65						85	150			85	150
HGP160D H	85							150				150
HGP100 F*	36	65	85	100		65	85	100		65	85	100
HGP100 S	65		85	150			85	150			85	150
HGP100 H	85			150				150				150
HGP160 F*	36					65	85	100		65	85	100
HGP160 S	65						85	150			85	150
HGP160 H	85							150				150
HGP250 F*	36									65	85	100
HGP250 S	65										85	150
HGP250 H	85											150

Upstream Circuit Breaker	HGP400				HGP630				HGP800			
	F*	S	H	X	F*	S	H	X	F*	S	H	X
Breaking Capacity [Icu] (kA r.m.s.)	36	70	85	150	36	70	85	150	36	70	85	150
Downstream Breaking Capacity [Icu] (kA r.m.s.)	Enhanced Breaking Capacity											
HGP50D/125D/160D F*	36	65	85	100		65	85	100		65	85	100
HGP50D/125D/160D S	65		85	150			85	150			85	150
HGP50D/125D/160D H	85			150				150				150
HGP100 F*	36	65	85	100		65	85	100		65	85	100
HGP100 S	65		85	150			85	150			85	150
HGP100 H	85			150				150				150
HGP160 F*	36	65	85	100		65	85	100		65	85	100
HGP160 S	65		85	150			85	150			85	150
HGP160 H	85			150				150				150
HGP250 F*	36	65	85	100		65	85	100		65	85	100
HGP250 S	65		85	150			85	150			85	150
HGP250 H	85			150				150				150
HGP400/630 F*	36	65	85	100		65	85	100		65	85	100
HGP400/630 S	70		85	150			85	150			85	150
HGP400/630 H	85			150				150				150
HGP800 F*	36									65	85	100
HGP800 S	70										85	150
HGP800 H	85											150

※ \* F type is for overseas sales.

# Technical Data (HGP)

## Discrimination Table

Ue < AC 460 V

Upstream : HGP50D ~ HGP800

Downstream : HGD32, HGD63, HGD125

Model	Trip Unit Rated Current (A)	HGP160DF*/S/H/X												
		Thermal Magnetic												
		16	20	25	32	40	50	63	75	80	100	125	150	160
HGD32 - B, C, D Curve	1	0.19	0.32	0.32	0.32	0.32	0.4	0.5	0.6	0.64	0.8	1	T	T
	3	0.19	0.32	0.32	0.32	0.32	0.4	0.5	0.6	0.64	0.8	1	T	T
	5	0.19	0.32	0.32	0.32	0.32	0.4	0.5	0.6	0.64	0.8	1	T	T
	6	0.19	0.32	0.32	0.32	0.32	0.4	0.5	0.6	0.64	0.8	1	T	T
	10	0.19	0.32	0.32	0.32	0.32	0.4	0.5	0.6	0.64	0.8	1	T	T
	16		0.32	0.32	0.32	0.32	0.4	0.5	0.6	0.64	0.8	1	T	T
	20			0.32	0.32	0.32	0.4	0.5	0.6	0.64	0.8	1	T	T
	25				0.32	0.32	0.4	0.5	0.6	0.64	0.8	1	T	T
	32					0.32	0.4	0.5	0.6	0.64	0.8	1	T	T
	40						0.4	0.5	0.6	0.64	0.8	1	T	T
HGD63 - B, C, D Curve	1	0.19	0.32	0.32	0.32	0.32	0.4	0.5	0.6	0.64	0.8	1	T	T
	2	0.19	0.32	0.32	0.32	0.32	0.4	0.5	0.6	0.64	0.8	1	T	T
	3	0.19	0.32	0.32	0.32	0.32	0.4	0.5	0.6	0.64	0.8	1	T	T
	4	0.19	0.32	0.32	0.32	0.32	0.4	0.5	0.6	0.64	0.8	1	T	T
	5	0.19	0.32	0.32	0.32	0.32	0.4	0.5	0.6	0.64	0.8	1	T	T
	6	0.19	0.32	0.32	0.32	0.32	0.4	0.5	0.6	0.64	0.8	1	T	T
	10	0.19	0.32	0.32	0.32	0.32	0.4	0.5	0.6	0.64	0.8	1	T	T
	13		0.32	0.32	0.32	0.32	0.4	0.5	0.6	0.64	0.8	1	T	T
	15		0.32	0.32	0.32	0.32	0.4	0.5	0.6	0.64	0.8	1	T	T
	16		0.32	0.32	0.32	0.32	0.4	0.5	0.6	0.64	0.8	1	T	T
	20			0.32	0.32	0.32	0.4	0.5	0.6	0.64	0.8	1	T	T
	25				0.32	0.32	0.4	0.5	0.6	0.64	0.8	1	T	T
	32					0.32	0.4	0.5	0.6	0.64	0.8	1	T	T
	40						0.4	0.5	0.6	0.64	0.8	1	T	T
	50							0.5	0.6	0.64	0.8	1	T	T
63								0.6	0.64	0.8	1	T	T	
HGD125 B, C, D Curve	63								0.64	0.8	2.4	2.4	2.4	
	80									0.8	2.4	2.4	2.4	
	100										2.4	2.4	2.4	
	125											2.4	2.4	

- T Total Discrimination, Up to the Breaking Capacity of the Downstream Circuit Breaker
- 4 Discrimination Limit = 4 kA
- No Discrimination

※ \* F type is for overseas sales.

Upstream : HGP50D ~ HGP800

Downstream : HGD32, HGD63, HGD125

Model	Trip Unit	HGP250 F*/S/H/X												HGP400 F*/S/H/X		HGP630 F*/S/H/X		HGP800 F*/S/H/X			
		Thermal Magnetic & Electronic																			
		Rated Current (A)	40	50	63	75	80	100	125	150	160	175	200	225	250	300	350	400	500	630	700
HGD32 - B, C, D Curve	1	0.32	0.4	0.5	0.6	0.64	0.8	T	T	T	T	T	T	T	T	T	T	T	T	T	T
	3	0.32	0.4	0.5	0.6	0.64	0.8	T	T	T	T	T	T	T	T	T	T	T	T	T	T
	5	0.32	0.4	0.5	0.6	0.64	0.8	T	T	T	T	T	T	T	T	T	T	T	T	T	T
	6	0.32	0.4	0.5	0.6	0.64	0.8	T	T	T	T	T	T	T	T	T	T	T	T	T	T
	10	0.32	0.4	0.5	0.6	0.64	0.8	T	T	T	T	T	T	T	T	T	T	T	T	T	T
	16	0.32	0.4	0.5	0.6	0.64	0.8	T	T	T	T	T	T	T	T	T	T	T	T	T	T
	20	0.32	0.4	0.5	0.6	0.64	0.8	T	T	T	T	T	T	T	T	T	T	T	T	T	T
	25	0.32	0.4	0.5	0.6	0.64	0.8	T	T	T	T	T	T	T	T	T	T	T	T	T	T
	32	0.32	0.4	0.5	0.6	0.64	0.8	T	T	T	T	T	T	T	T	T	T	T	T	T	T
	40		0.4	0.5	0.6	0.64	0.8	T	T	T	T	T	T	T	T	T	T	T	T	T	T
HGD63 - B, C, D Curve	1	0.32	0.4	0.5	0.6	0.64	0.8	T	T	T	T	T	T	T	T	T	T	T	T	T	T
	2	0.32	0.4	0.5	0.6	0.64	0.8	T	T	T	T	T	T	T	T	T	T	T	T	T	T
	3	0.32	0.4	0.5	0.6	0.64	0.8	T	T	T	T	T	T	T	T	T	T	T	T	T	T
	4	0.32	0.4	0.5	0.6	0.64	0.8	T	T	T	T	T	T	T	T	T	T	T	T	T	T
	5	0.32	0.4	0.5	0.6	0.64	0.8	T	T	T	T	T	T	T	T	T	T	T	T	T	T
	6	0.32	0.4	0.5	0.6	0.64	0.8	T	T	T	T	T	T	T	T	T	T	T	T	T	T
	10	0.32	0.4	0.5	0.6	0.64	0.8	T	T	T	T	T	T	T	T	T	T	T	T	T	T
	13	0.32	0.4	0.5	0.6	0.64	0.8	T	T	T	T	T	T	T	T	T	T	T	T	T	T
	15	0.32	0.4	0.5	0.6	0.64	0.8	T	T	T	T	T	T	T	T	T	T	T	T	T	T
	16	0.32	0.4	0.5	0.6	0.64	0.8	T	T	T	T	T	T	T	T	T	T	T	T	T	T
	20	0.32	0.4	0.5	0.6	0.64	0.8	T	T	T	T	T	T	T	T	T	T	T	T	T	T
	25	0.32	0.4	0.5	0.6	0.64	0.8	T	T	T	T	T	T	T	T	T	T	T	T	T	T
	32	0.32	0.4	0.5	0.6	0.64	0.8	T	T	T	T	T	T	T	T	T	T	T	T	T	T
	40		0.4	0.5	0.6	0.64	0.8	T	T	T	T	T	T	T	T	T	T	T	T	T	T
50			0.5	0.6	0.64	0.8	T	T	T	T	T	T	T	T	T	T	T	T	T	T	
63				0.6	0.64	0.8	T	T	T	T	T	T	T	T	T	T	T	T	T	T	
HGD125 B, C, D Curve	63				0.64	0.8	2.4	2.4	2.4	T	T	T	T	T	T	T	T	T	T	T	T
	80					0.8	2.4	2.4	2.4	T	T	T	T	T	T	T	T	T	T	T	T
	100						2.4	2.4	2.4	T	T	T	T	T	T	T	T	T	T	T	T
	125						2.4	2.4	2.4	T	T	T	T	T	T	T	T	T	T	T	T

- T Total Discrimination, Up to the Breaking Capacity of the Downstream Circuit Breaker
- 4 Discrimination Limit = 4 kA
- No Discrimination

※ \* F type is for overseas sales.

# Technical Data (HGP)

## Discrimination Table

Ue < AC 460 V

Upstream : HGP50D ~ HGP800

Downstream : HGM30 ~ HGM800

		HGP160D F*/S/H/X												
Model	Trip Unit	Thermal Magnetic												
	Rated Current (A)	16	20	25	32	40	50	63	75	80	100	125	150	160
HGM30 E/S HGM50 E/S HGM60 E/S/H/L HGM100 E/S/H/L	16							0.5	0.6	0.64	0.8	1	1.25	1.25
	20							0.5	0.6	0.64	0.8	1	1.25	1.25
	25							0.5	0.6	0.64	0.8	1	1.25	1.25
	32							0.5	0.6	0.64	0.8	1	1.25	1.25
	40									0.64	0.8	1	1.25	1.25
	50									0.64	0.8	1	1.25	1.25
	63										0.8	1	1.25	1.25
	75											1	1.25	1.25
	80											1	1.25	1.25
	100													1.25
HGM125 E/S/H/L	16							0.5	0.6	0.64	0.8	1	1.25	1.25
	20							0.5	0.6	0.64	0.8	1	1.25	1.25
	25							0.5	0.6	0.64	0.8	1	1.25	1.25
	32							0.5	0.6	0.64	0.8	1	1.25	1.25
	40									0.64	0.8	1	1.25	1.25
	50									0.64	0.8	1	1.25	1.25
	63										0.8	1	1.25	1.25
	75											1	1.25	1.25
	80											1	1.25	1.25
	100													1.25
HGM160 E/S/H/L HGM250 E/S/H/L	100													
	125													
	150													
	160													
	175													
	200													
	225													
	250													
	250													
	300													
HGM400 E/S/H/L	350													
	400													
HGM630 E/S/H/L HGM800 S/H/L	500													
	630													
	700													
	800													

- T Total Discrimination, Up to the Breaking Capacity of the Downstream Circuit Breaker
- 4 Discrimination Limit = 4 kA
- No Discrimination

※ \* F type is for overseas sales.

Upstream : HGP50D ~ HGP800  
 Downstream : HGM30 ~ HGM800

Model	Trip Unit Rated Current (A)	HGP250 F*/S/H/X																HGP400 F*/S/H/X		HGP630 F*/S/H/X		HGP800 F*/S/H/X		
		Thermal Magnetic & Electronic																300	350	400	500	630	700	800
		40	50	63	75	80	100	125	150	160	175	200	225	250										
HGM30 E/S HGM50 E/S HGM60 E/S/H/L HGM100 E/S/H/L	16			0.5	0.6	0.64	0.8	1	1.25	1.25	1.4	1.6	1.8	2	T	T	T	T	T	T	T			
	20			0.5	0.6	0.64	0.8	1	1.25	1.25	1.4	1.6	1.8	2	T	T	T	T	T	T	T			
	25			0.5	0.6	0.64	0.8	1	1.25	1.25	1.4	1.6	1.8	2	T	T	T	T	T	T	T			
	32			0.5	0.6	0.64	0.8	1	1.25	1.25	1.4	1.6	1.8	2	T	T	T	T	T	T	T			
	40				0.6	0.64	0.8	1	1.25	1.25	1.4	1.6	1.8	2	T	T	T	T	T	T	T			
	50					0.64	0.8	1	1.25	1.25	1.4	1.6	1.8	2	T	T	T	T	T	T	T			
	63						0.8	1	1.25	1.25	1.4	1.6	1.8	2	T	T	T	T	T	T	T			
	75							1	1.25	1.25	1.4	1.6	1.8	2	T	T	T	T	T	T	T			
	80							1	1.25	1.25	1.4	1.6	1.8	2	T	T	T	T	T	T	T			
	100									1.25	1.4	1.6	1.8	2	T	T	T	T	T	T	T			
HGM125 E/S/H/L	16			0.5	0.6	0.64	0.8	1	1.25	1.25	1.4	1.6	1.8	2	T	T	T	T	T	T	T			
	20			0.5	0.6	0.64	0.8	1	1.25	1.25	1.4	1.6	1.8	2	T	T	T	T	T	T	T			
	25			0.5	0.6	0.64	0.8	1	1.25	1.25	1.4	1.6	1.8	2	T	T	T	T	T	T	T			
	32			0.5	0.6	0.64	0.8	1	1.25	1.25	1.4	1.6	1.8	2	T	T	T	T	T	T	T			
	40				0.6	0.64	0.8	1	1.25	1.25	1.4	1.6	1.8	2	T	T	T	T	T	T	T			
	50					0.64	0.8	1	1.25	1.25	1.4	1.6	1.8	2	T	T	T	T	T	T	T			
	63						0.8	1	1.25	1.25	1.4	1.6	1.8	2	T	T	T	T	T	T	T			
	75							1	1.25	1.25	1.4	1.6	1.8	2	T	T	T	T	T	T	T			
	80							1	1.25	1.25	1.4	1.6	1.8	2	T	T	T	T	T	T	T			
	100									1.25	1.4	1.6	1.8	2	T	T	T	T	T	T	T			
HGM160 E/S/H/L HGM250 E/S/H/L	125									1.4	1.6	1.8	2	T	T	T	T	T	T	T				
	100									1.25	1.4	1.6	1.8	2	2.4	2.8	3.8	4	5	T	T			
	125											1.6	1.8	2	2.4	2.8	3.8	4	5	T	T			
	150													2	2.4	2.8	3.8	4	5	T	T			
	160														2	2.4	2.8	3.8	4	5	T	T		
	175															2.4	2.8	3.8	4	5	T	T		
	200																2.4	2.8	3.8	4	5	T	T	
	225																	2.8	3.8	4	5	T	T	
HGM400 E/S/H/L	250																	3.8	4	5	T	T		
	250																		4	5	5.6	6.4		
	300																		4	5	5.6	6.4		
	350																			5	5.6	6.4		
HGM630 E/S/H/L HGM800 S/H/L	400																			5	5.6	6.4		
	500																				5.6	6.4		
	630																					6.4		
	700																							
800																								

※ \* F type is for overseas sales.

# Technical Data (HGP)

## Discrimination Table

Ue < AC 460 V

Upstream : HGP50D ~ HGP800

Downstream : HGP50D ~ HGP800

Model	Trip Unit Rated Current (A)	HGP160D F*/S/H/X												
		Thermal Magnetic												
		16	20	25	32	40	50	63	75	80	100	125	150	160
HGP50D F*/S/H/X	16							0.5	0.6	0.64	0.8	1	1.25	1.25
	20							0.5	0.6	0.64	0.8	1	1.25	1.25
	25							0.5	0.6	0.64	0.8	1	1.25	1.25
	32							0.5	0.6	0.64	0.8	1	1.25	1.25
	40									0.64	0.8	1	1.25	1.25
	50									0.64	0.8	1	1.25	1.25
	HGP125D F*/S/H/X	63									0.8	1	1.25	1.25
	HGP160D F*/S/H/X	75										1	1.25	1.25
		80										1	1.25	1.25
		100												1.25
	125													
	150													
	160													
HGP250 F*/S/H/X	100													
	125													
	150													
	160													
	175													
	200													
	225													
HGP400 F*/S/H/X HGP630 F*/S/H/X	250													
	300													
	350													
	400													
HGP800 F*/S/H/X	500													
	630													
	700													
	800													

T Total Discrimination, Up to the Breaking Capacity of the Downstream Circuit Breaker

4 Discrimination Limit = 4 kA

No Discrimination

※ \* F type is for overseas sales.

Upstream : HGP50D ~ HGP800  
 Downstream : HGP50D ~ HGP800

Model	Trip Unit	HGP250 F*/S/H/X																HGP400 F*/S/H/X		HGP630 F*/S/H/X		HGP800 F*/S/H/X	
		Thermal Magnetic & Electronic																					
		Rated Current (A)	40	50	63	75	80	100	125	150	160	175	200	225	250	300	350	400	500	630	700	800	
HGP50D F*/S/H/X HGP125D F*/S/H/X HGP160D F*/S/H/X	16			0.5	0.6	0.64	0.8	1	1.25	36	36	36	36	36	T	T	T	T	T	T	T		
	20			0.5	0.6	0.64	0.8	1	1.25	1.25	36	36	36	36	T	T	T	T	T	T	T		
	25			0.5	0.6	0.64	0.8	1	1.25	1.25	1.4	36	36	36	T	T	T	T	T	T	T		
	32			0.5	0.6	0.64	0.8	1	1.25	1.25	1.4	36	36	36	T	T	T	T	T	T	T		
	40					0.64	0.8	1	1.25	1.25	1.4	36	36	36	T	T	T	T	T	T	T		
	50					0.64	0.8	1	1.25	1.25	1.4	36	36	36	T	T	T	T	T	T	T		
	63						0.8	1	1.25	1.25	1.4	36	36	36	T	T	T	T	T	T	T		
	75							1	1.25	1.25	1.4	36	36	36	T	T	T	T	T	T	T		
	80							1	1.25	1.25	1.4	36	36	36	T	T	T	T	T	T	T		
	100									1.25	1.4	1.6	36	36	T	T	T	T	T	T	T		
	125											1.6	1.8	36	T	T	T	T	T	T	T		
150												1.8	2	T	T	T	T	T	T	T			
160													2	T	T	T	T	T	T	T			
HGP250 F*/S/H/X	40					0.64	0.8	1	1.25	1.25	1.4	1.6	1.8	2	36	36	36	T	T	T	T		
	50					0.64	0.8	1	1.25	1.25	1.4	1.6	1.8	2	36	36	36	T	T	T	T		
	63						0.8	1	1.25	1.25	1.4	1.6	1.8	2	36	36	36	T	T	T	T		
	75							1	1.25	1.25	1.4	1.6	1.8	2	36	36	36	T	T	T	T		
	80							1	1.25	1.25	1.4	1.6	1.8	2	36	36	36	T	T	T	T		
	100									1.25	1.4	1.6	1.8	2	36	36	36	T	T	T	T		
	125											1.6	1.8	2	36	36	36	T	T	T	T		
	150													2	36	36	36	T	T	T	T		
	160														2	2.4	36	36	T	T	T	T	
	175															2.4	2.8	36	36	36	T	T	
	200															2.4	2.8	3.8	36	36	T	T	
225																2.8	3.8	36	36	T	T		
250																	3.8	4	36	T	T		
300																		4	5	36	36		
HGP400 F*/S/H/X	350																		5	36	36		
HGP630 F*/S/H/X	400																		5	5.6	36		
	500																			5.6	6.4		
	630																				6.4		
HGP800 F*/S/H/X	700																						
	800																						

T Total Discrimination, Up to the Breaking Capacity of the Downstream Circuit Breaker

4 Discrimination Limit = 4 kA

No Discrimination

※ \* F type is for overseas sales.

## Technical Data (HGP)

### Type 2 Coordination (IEC 60947-4-1)

#### AC 440 V

Performance : Ue = 440 V

Circuit breakers	F*	S	H
HGP100/250	36	65	85
HGP400/630	36	65	85
HGP800	36	65	85

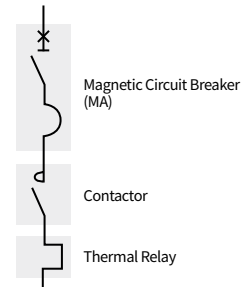

Motor			Circuit Breakers			Contactors		Thermal o/l relays	
P (kW)	I (A) 440V	Ie Max (A)	Type	Rating (A)	Ii (A)	Type	Type	Irth (A)	
0.37	1.1	1.6	HGP100	2.5	32.5	HGC18	HGT18 <sup>1)</sup>	0.8 ~ 1.2	
0.55	1.4	1.6	HGP100	2.5	32.5	HGC18	HGT18 <sup>1)</sup>	1.1 ~ 1.6	
0.75	1.7	2.5 <sup>2)</sup>	HGP100	2.5	32.5	HGC18	HGT18 <sup>1)</sup>	1.5 ~ 2.1 <sup>2)</sup>	
1.1	2.4	2.5	HGP100	3.2	41.6	HGC18	HGT18 <sup>1)</sup>	2 ~ 3	
1.5	3.1	4	HGP100	6.3	81.9	HGC40	HGT18 <sup>1), 4)</sup>	2.8 ~ 4.2	
2.2	4.5	6	HGP100	6.3	81.9	HGC40	HGT18 <sup>1), 4)</sup>	4 ~ 6	
3	5.8	6	HGP100	6.3	81.9	HGC40	HGT18 <sup>1), 4)</sup>	5.6 ~ 8	
4	8	8	HGP100	12.5	163	HGC65	HGT65 <sup>1), 4)</sup>	6 ~ 9	
5.5	10.5	12.5 <sup>3)</sup>	HGP100	12.5	163	HGC65	HGT65 <sup>1), 4)</sup>	8 ~ 12 <sup>3)</sup>	
7.5	13.7	18	HGP100	32	416	HGC65	HGT65 <sup>1)</sup>	12 ~ 18	
10	19	25	HGP100	32	416	HGC65	HGT100 <sup>1)</sup>	17 ~ 25	
11	20	25	HGP100	32	320	HGC100	HGT100 <sup>1)</sup>	17 ~ 25	
15	26.5	32	HGP100	50	650	HGC100	HGT100	22 ~ 32	
18.5	33	40	HGP100	50	650	HGC100	HGT100	28 ~ 40	
22	39	40	HGP100	50	650	HGC100	HGT100	34 ~ 50	
30	52	63	HGP100	100	1300	HGC115	HGT150	48 ~ 80	
37	63	63	HGP100	100	1300	HGC130	HGT150	48 ~ 80	
45	76	80	HGP250	125	1250	HGC150	HGT150	48 ~ 80	
55	90	100	HGP250	160	1600	HGC150	HGT150	69 ~ 115	
75	125	150	HGP250	200	2000	HGC150	HGT150	90 ~ 150	
90	140	150	HGP250	200	2000	HGC150	HGT150	111 ~ 185	
110	178	185	HGP250	250	2500	HGC185	HGT265	135 ~ 225	
132	210	265	HGP400	350	3500	HGC265	HGT265	180 ~ 300	
160	256	265	HGP400	350	3500	HGC265	HGT265	180 ~ 300	
200	310	320	HGP630	400	4000	HGC400	HGT500	240 ~ 400	
220	353	400	HGP630	630	6300	HGC400	HGT500	300 ~ 500	
250	400	500	HGP630	700	7000	HGC500	HGT500	300 ~ 500	
300	460	500	HGP800	700	7000	HGC500	HGT800	378 ~ 630	
		630	HGP800	800	8000	HGC630	HGT800	378 ~ 630	
335	540	630	HGP800	800	8000	HGC800	HGT800	378 ~ 630	
375	575	630	HGP800	800	8000	HGC800	HGT800	378 ~ 630	

※ 1) Iq < 50 kA

2) TOR Thermal Maximum Rating 2.1 A

3) TOR Thermal Maximum Rating 12 A

4) Type 1 Only for Thermal Relay

\* F type is for overseas sales.



## Installation

### Insulation Distance (Safety Clearance)

For safety, insulation distance must be secured at installation. In case of installing a circuit breaker, safety clearances must be secured between breakers or between the circuit breaker and panel, bus bar and other adjacent devices. When the circuit breaker interrupts a short circuit, high temperature ionized gas is generated and the gas is discharged through the discharge outlet from the circuit breaker. As this gas can cause short-circuit accidents and grounding accidents, sufficient insulation distance is required between the circuit breaker and the panel.

※ In case insulation barrier is not installed between the circuit breaker terminals, secondary short-circuit accident may occur so it must be used. The insulation barrier must be installed towards the both directions of the circuit breaker's line / load indication part.

Separation distance in case the circuit breaker is installed side by side

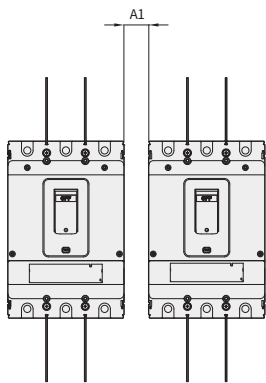

Up/down/left/right distance in case of metallic panel

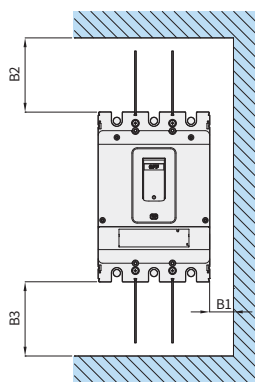

Front/back distance in case of metallic panel

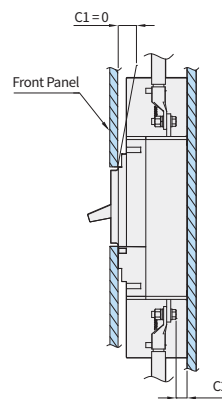

Distance with circuit breaker in case the live part is exposed

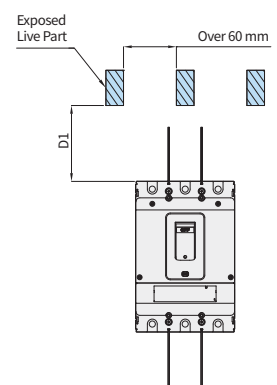

※ In case of using the minimum separation distance(A1 = 0), terminal cover and phase to phase barrier must be assembled between the product. And pay attention to the tolerances of the enclosure dimensions.

※ If the distance between the live parts is less than 60 mm, the exposed part must be insulated.

### HGP Type's Minimum Insulation Distance

Type	Minimum Clearance (mm)														
	460 V							240 V							
	A1	B1	B2	B3	C1	C2	D1	A1	B1	B2	B3	C1	C2	D1	
HGP50D F*/S	0	10	50	50	0	8	350	0/50	10	50	50	0	8	350	
HGP50D H/X	0	10	50	50	0	8	350	0/50	10	50	50	0	8	350	
HGP125D F*/S	0	10	50	50	0	8	350	0/50	10	50	50	0	8	350	
HGP125D H/X	0	10	50	50	0	8	350	0/50	10	50	50	0	8	350	
HGP160D F*/S	0	10	50	50	0	8	350	0/50	10	50	50	0	8	350	
HGP160D H/X	0	10	50	50	0	8	350	0/50	10	50	50	0	8	350	
HGP100 F*/S	0	10	50	50	0	8	350	0/50	10	50	50	0	8	350	
HGP100 H/X	0	10	50	50	0	8	350	0/50	10	50	50	0	8	350	
HGP160 F*/S	0	10	50	50	0	8	350	0/50	10	50	50	0	8	350	
HGP160 H/X	0	10	50	50	0	8	350	0/50	10	50	50	0	8	350	
HGP250 F*/S	0	10	50	50	0	8	350	0/50	10	50	50	0	8	350	
HGP250 H/X	0	10	50	50	0	8	350	0/50	10	50	50	0	8	350	
HGP400 F*/S	0	40	116	116	0	8	350	0/50	15	116	116	0	8	350	
HGP400 H/X	0	40	116	116	0	8	350	0/50	15	116	116	0	8	350	
HGP630 F*/S	0	40	116	116	0	8	350	0/50	15	116	116	0	8	350	
HGP630 H/X	0	40	116	116	0	8	350	0/50	15	116	116	0	8	350	
HGP800 F*/S	0	45	115	115	0	8	350	0/50	20	115	115	0	8	350	
HGP800 H/X	0	45	115	115	0	8	350	0/50	20	115	115	0	8	350	

※ \* F type is for overseas sales.

## Technical Data (HGP)

### Installation

#### Installation Angle

The HGP Type of circuit breakers can be installed vertically or horizontally without changing any characteristics and as for the detailed installation direction, please refer to the figure below.

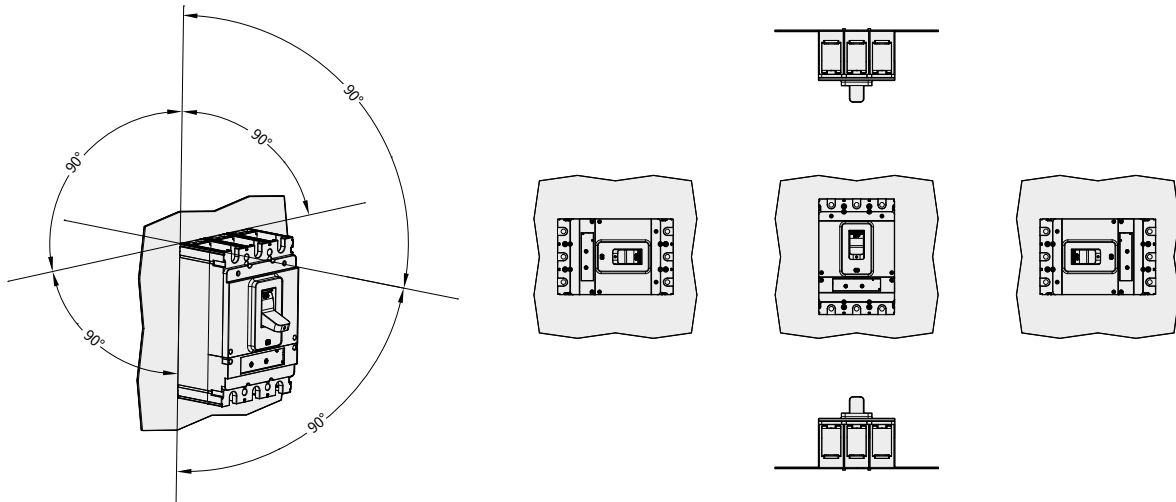

#### Direction of Power Supply

As for the HGP Type circuit breaker, the breaking power of circuit breaker does not drop even if power is supplied to the load side. So, power can be supplied to any direction regardless of the line side/load side for use. With regards to the use in reverse connection, HGP got DEKRA Certificate under IEC 60947-2.

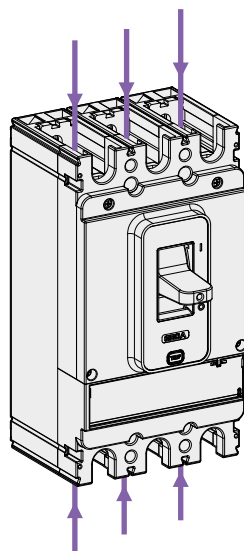



## Standard Configuration

### HGP Type

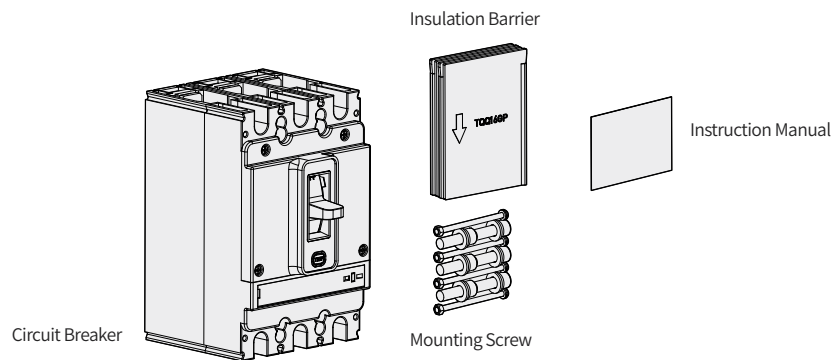

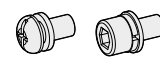

HGP50D, HGP125D, HGP160D, HGP100, HGP160, HGP250

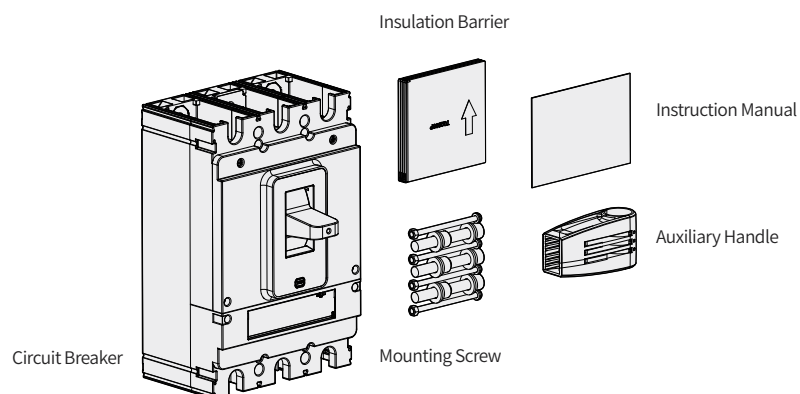

MCCB	Part			
HGP50D, HGP125D, HGP160D	3P	4 EA (M4×L85)	6 EA (PH Screw P·S/W M8×L18)	4 EA
	4P	5 EA (M4×L85)	8 EA (PH Screw P·S/W M8×L18)	6 EA
HGP100, HGP160, HGP250	3P	4 EA (M4×L85)	6 EA (Hex Socket P·S/W M8×L20)	4 EA
	4P	6 EA (M4×L85)	8 EA (Hex Socket P·S/W M8×L20)	6 EA

HGP400, HGP630, HGP800



MCCB	Part				
HGP400, HGP630	3P	4 EA (M5×L98)	6 EA (Hex Socket P·S/W M10×L30)	4 EA	1 EA
	4P	5 EA (M5×L98)	8 EA (Hex Socket P·S/W M10×L30)	6 EA	1 EA
HGP800	3P	4 EA (M6×L110)	6 EA (Hex Socket P·S/W M12×L35)	4 EA	1 EA
	4P	6 EA (M6×L110)	8 EA (Hex Socket P·S/W M12×L35)	6 EA	1 EA

## Technical Data (HGP)

### MCCB Assembly and Terminal Mounting Specification

#### HGP Type

HGP Type circuit breaker can be mounted directly on the panel by using a screw. In case there is a bus bar or terminal at the back of the panel, insulation distance requires your attention. The wire and bus bar have to be wired according to the terminal part's specification for power supply of circuit breaker and fastened according to the specified tightening torque.

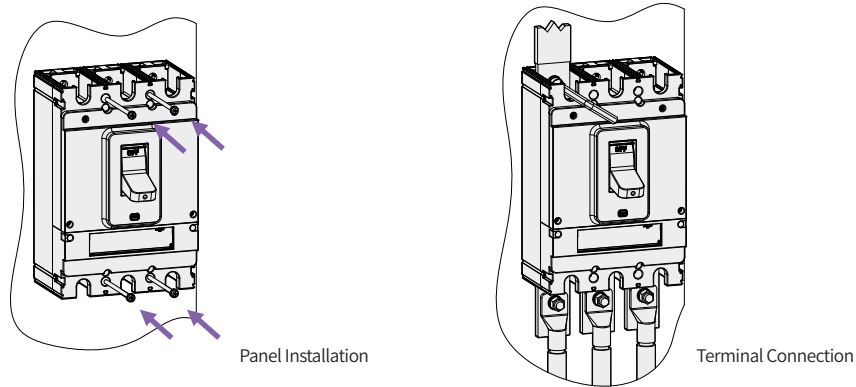

No	Type	Panel Mounting		Connection Terminal		
		Screw Specification	Terminal Connection Method and Dimensions (mm)	Conductor Processing	Tightening Torque	
1	HGP50D HGP125D HGP160D	M4 : 13 kgf.cm				M8 : 50 ~ 70 kgf.cm
2	HGP100 HGP160 HGP250	M4 : 13 kgf.cm				M8 : 80 ~ 130 kgf.cm
3	HGP400 HGP630	M5 : 28.5 kgf.cm				M10 : 140 ~ 270 kgf.cm
4	HGP800	M6 : 45 kgf.cm				M12 : 350 ~ 470 kgf.cm

# Operation Characteristic Curve

HGM/HGE100 (16 ~ 32 A)

• HGM/HGE30, 50E/S, 60, 100

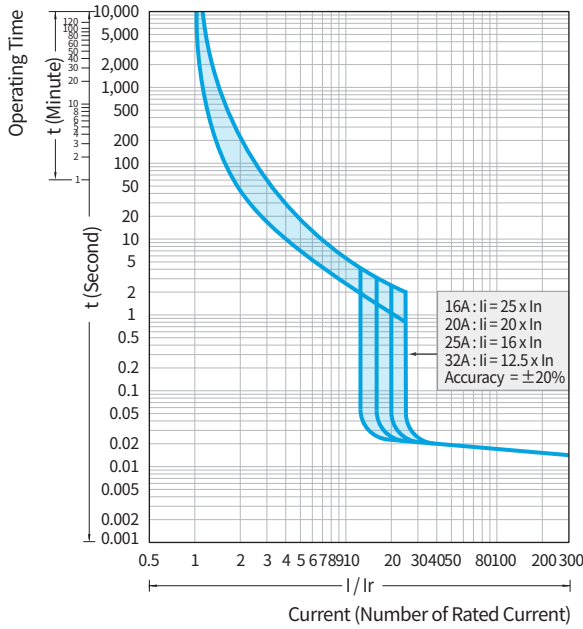

Ambient Temperature Derating Curve

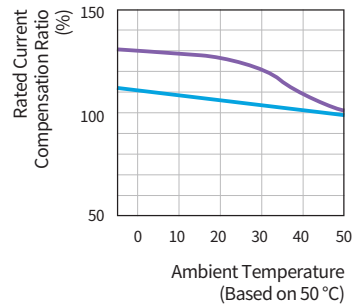
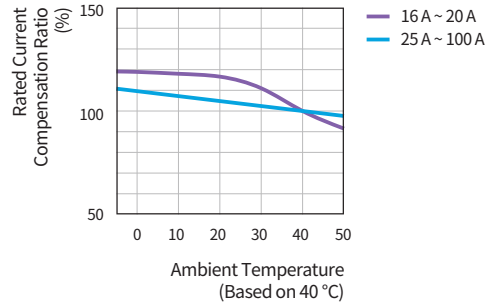

HGM/HGE100 (40 ~ 100 A)

• HGM/HGE50E/S, 60, 100

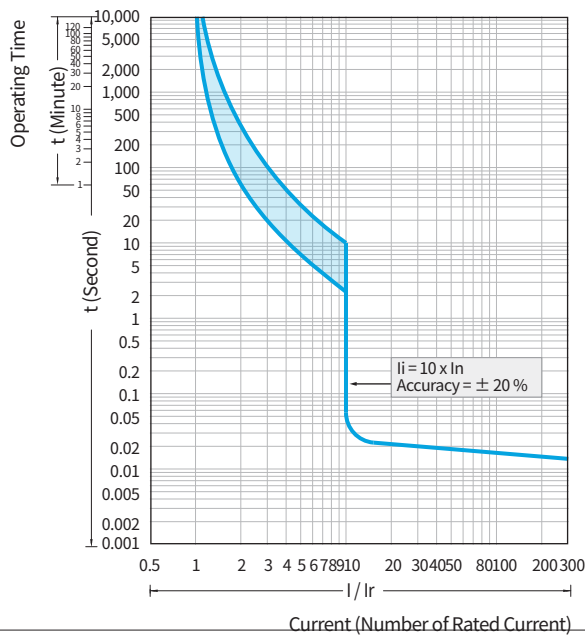

Ambient Temperature Derating Curve

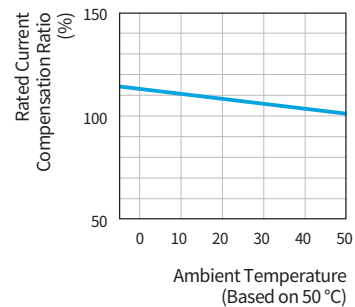
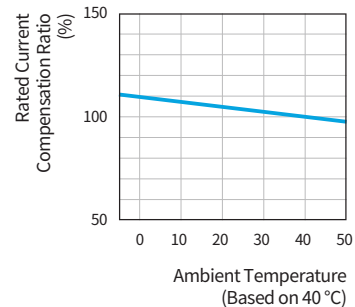

# Operation Characteristic Curve

HGM/HGE125 (16 ~ 32 A)

• HGM/HGE50H/L, 125

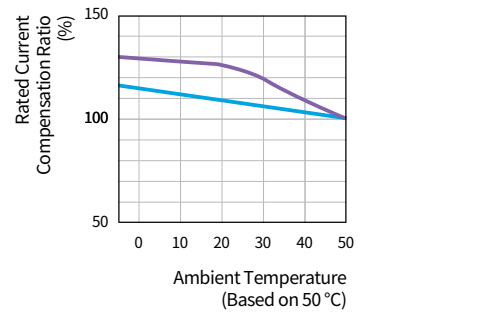
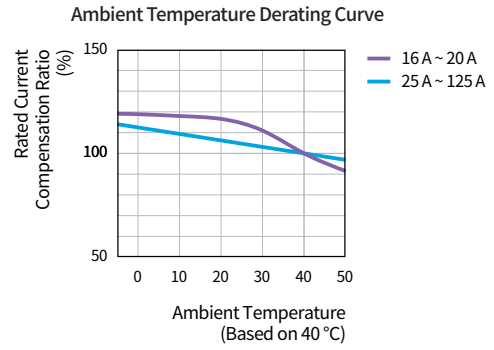
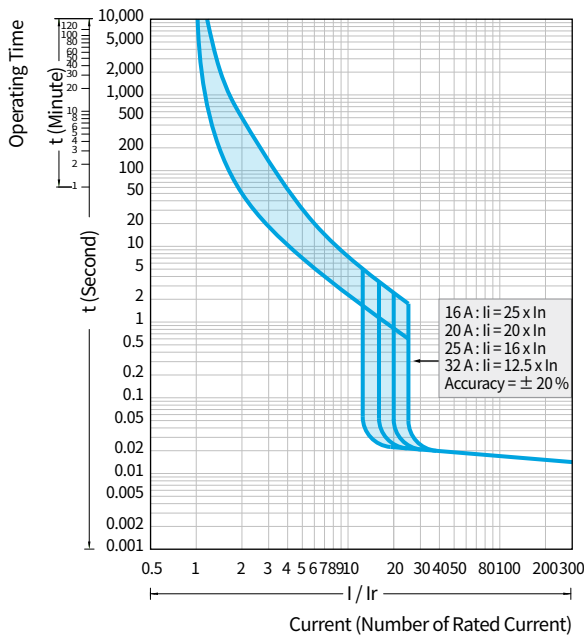

HGM/HGE125 (40 ~ 125 A)

• HGM/HGE50H/L, 125

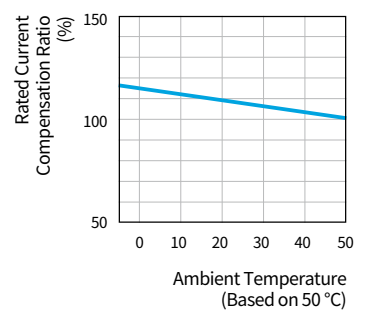
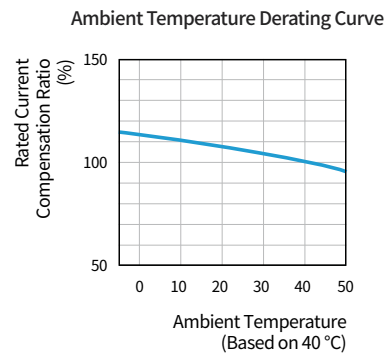
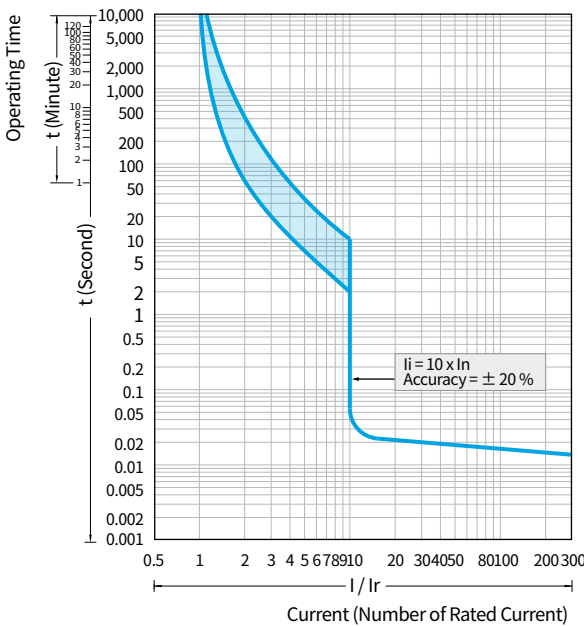

HGM/HGE250 (100 ~ 250 A)

• HGM/HGE160, 250

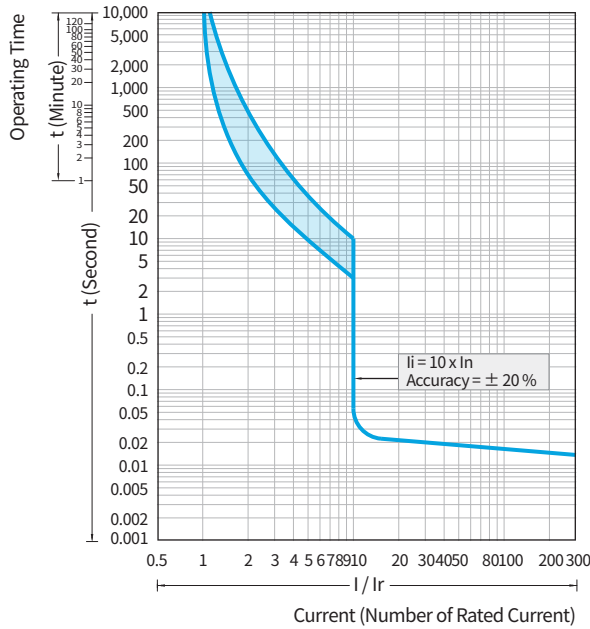

Ambient Temperature Derating Curve

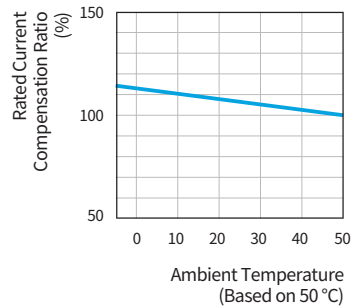
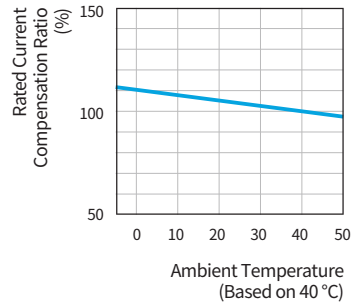

HGM400

• HGM400

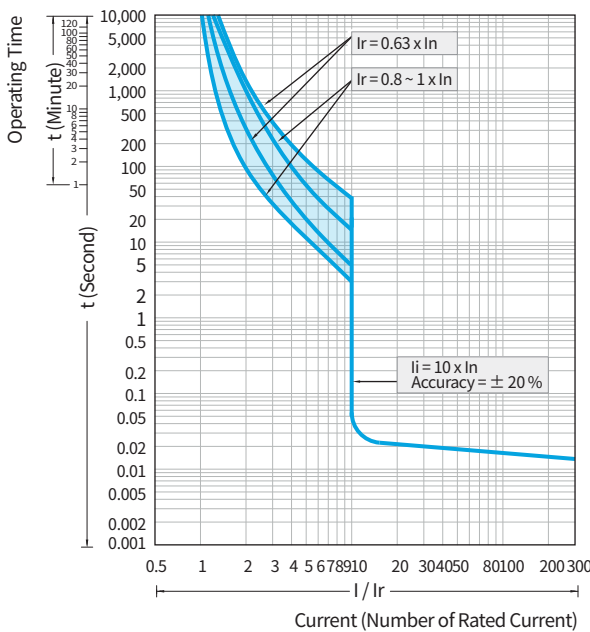

Ambient Temperature Derating Curve

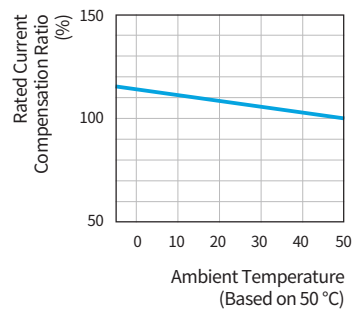
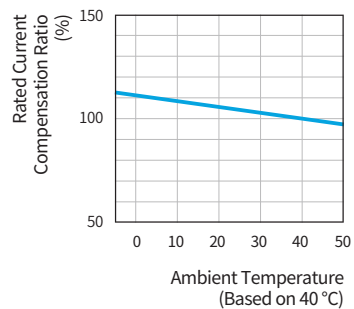

# Operation Characteristic Curve

HGM800 (500 ~ 800 A)

• HGM630, 800

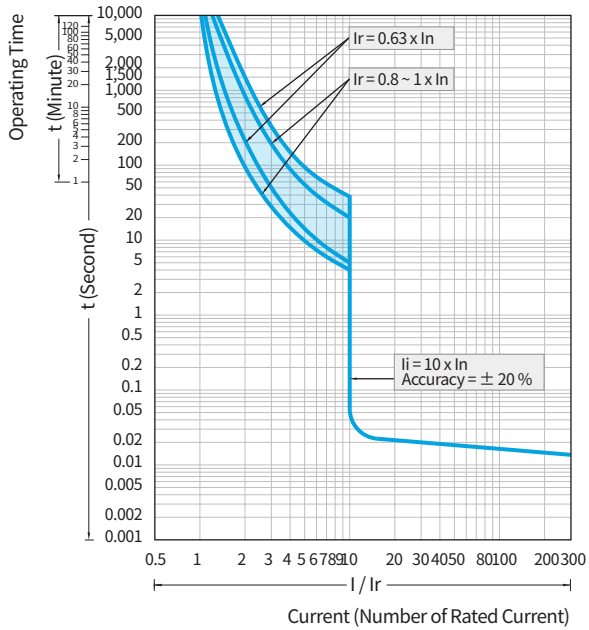

Ambient Temperature Derating Curve

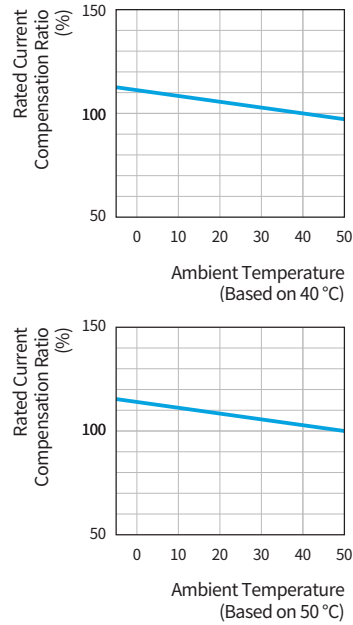

HGE400

• HGE400

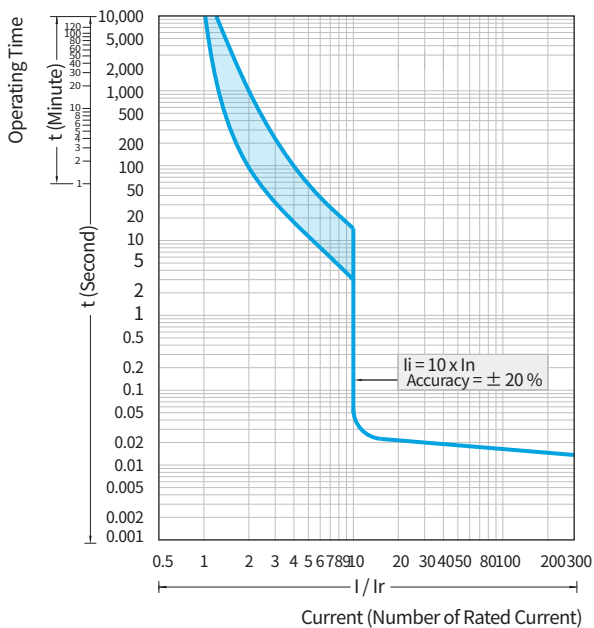

Ambient Temperature Derating Curve

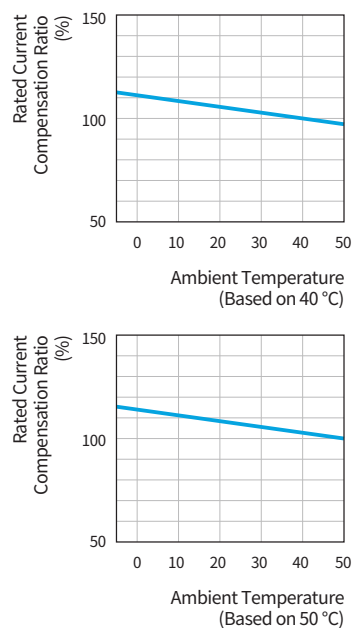



HGE800 (500 ~ 800 A)

• HGE630, 800

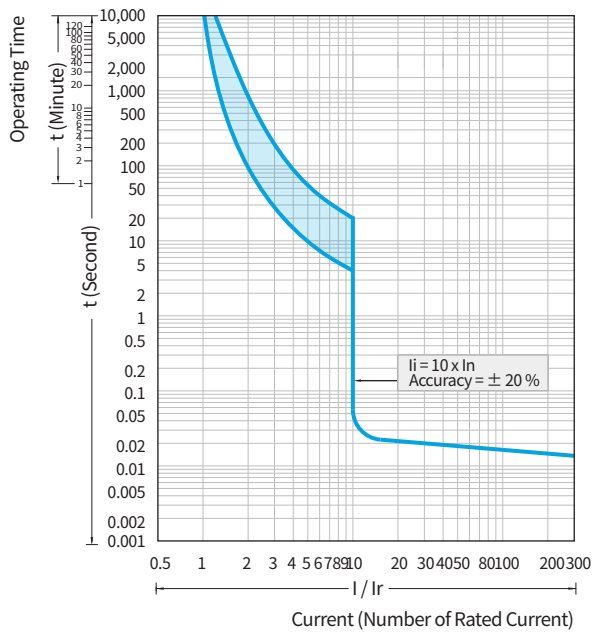

Ambient Temperature Derating Curve

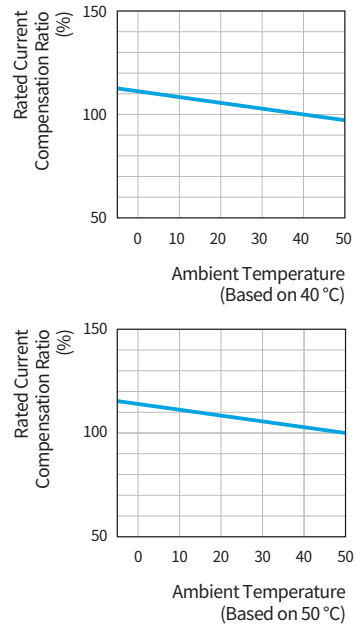

# Current & Energy-Limiting Characteristic Curve

## Current-Limiting Characteristic Curve

• Based on 400/460 V

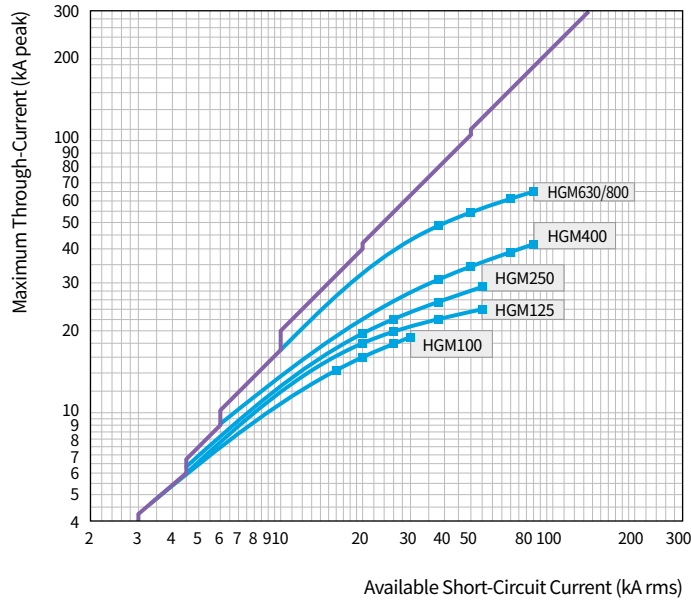

## Energy-Limiting Characteristic Curve

• Based on 400/460 V

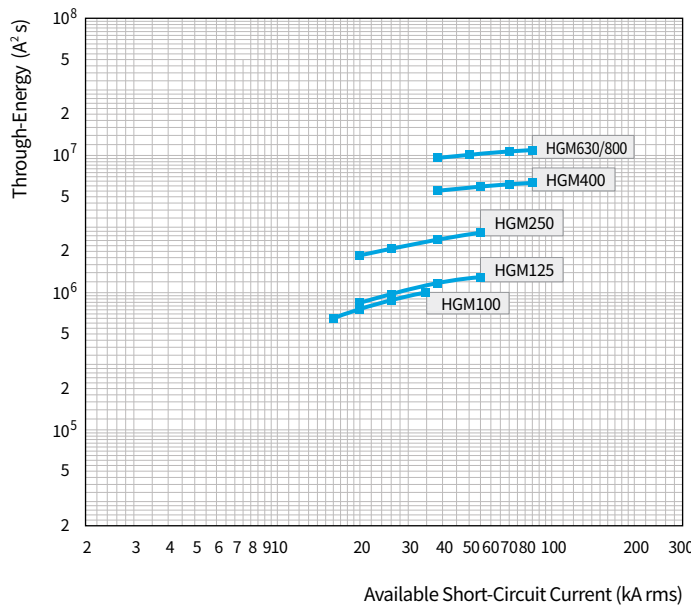



# Operation Characteristic Curve (HGP Thermal Magnetic Type)

## HGP160D (16 ~ 32 A)

• HGP50D, 125D

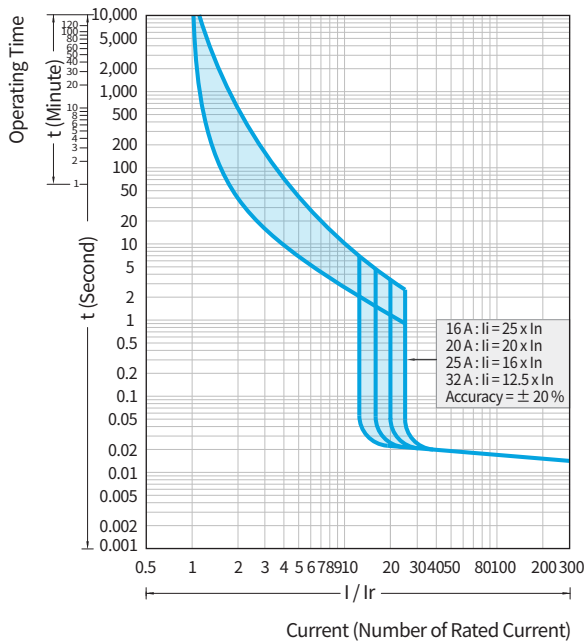

Ambient Temperature Derating Curve

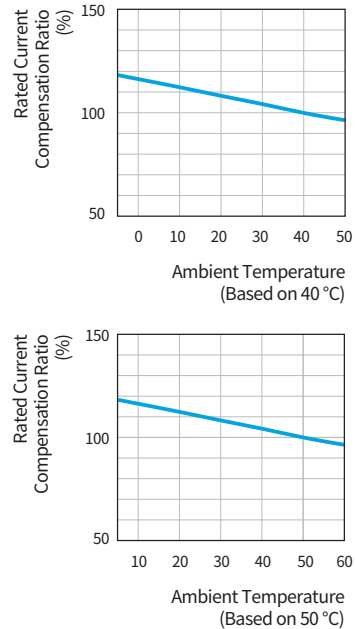

## HGP160D (40 ~ 160 A)

• HGP50D, 125D, 160D

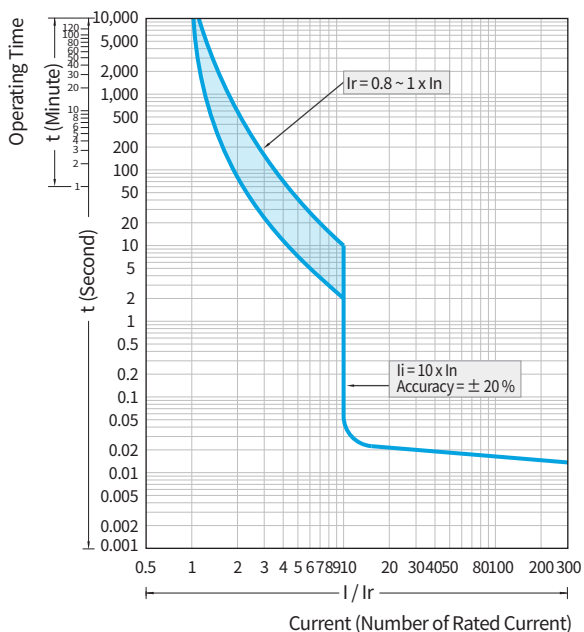

Ambient Temperature Derating Curve

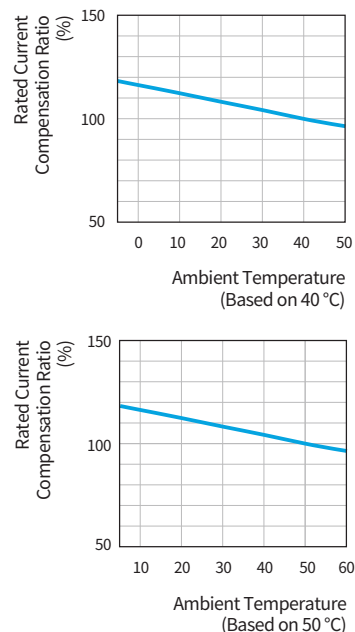

HGP250

• HGP100, 160, 250

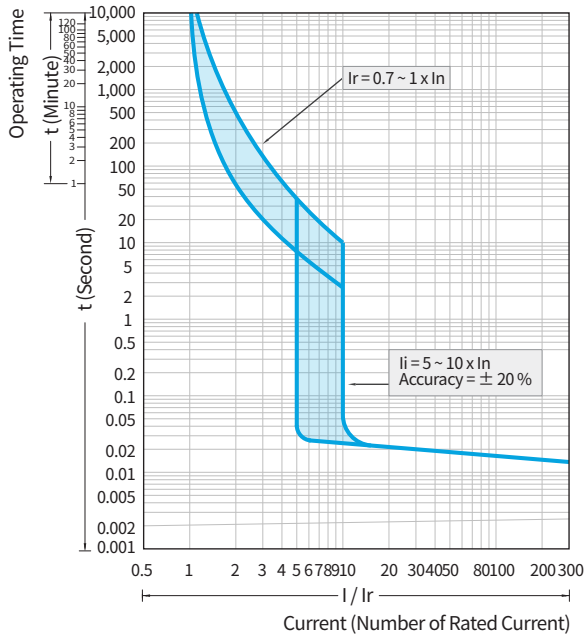

Ambient Temperature Derating Curve

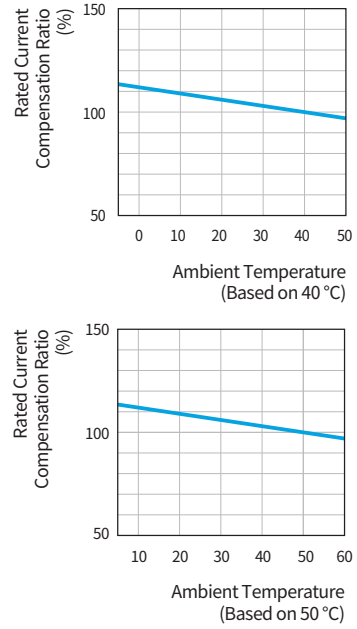

# Operation Characteristic Curve (HGP Thermal Magnetic Type)

HGP630 (300 ~ 630 A)

• HGP400, 630

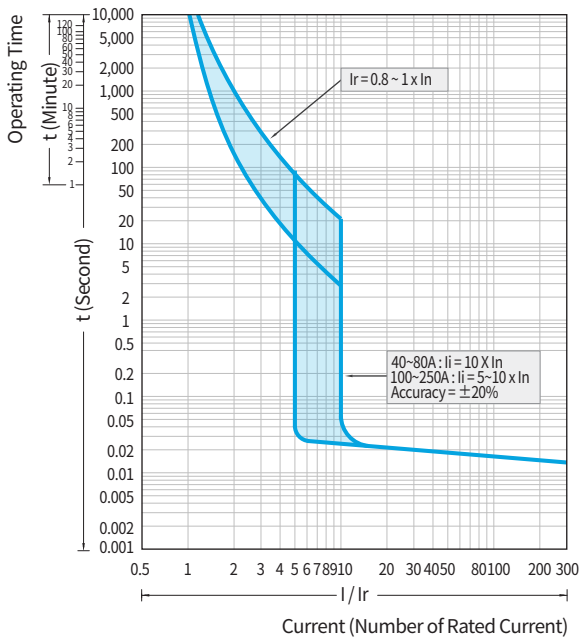

Ambient Temperature Derating Curve

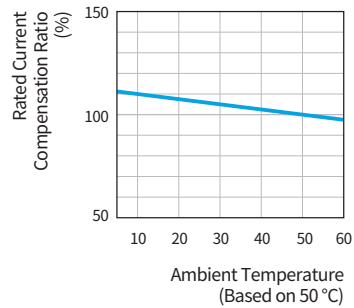
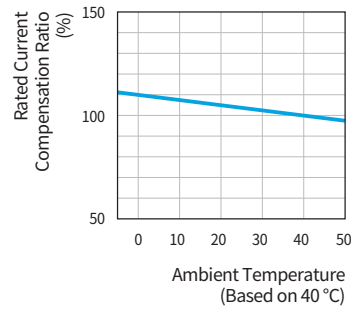

HGP800 (700 ~ 800 A)

• HGP800

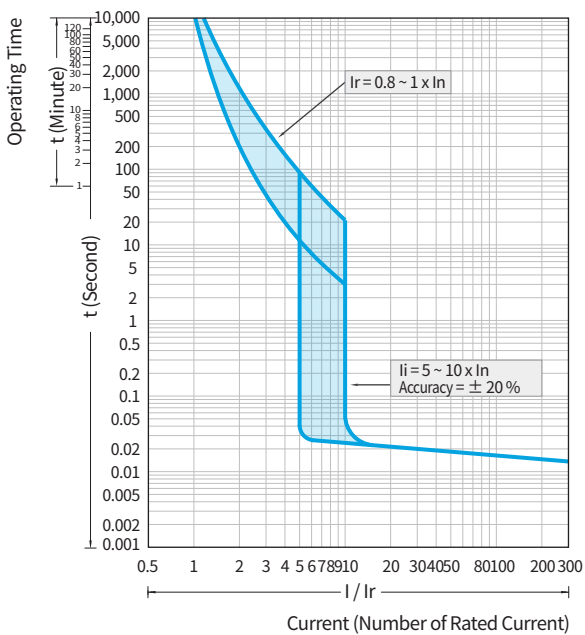

Ambient Temperature Derating Curve

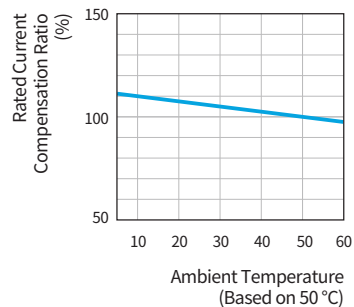
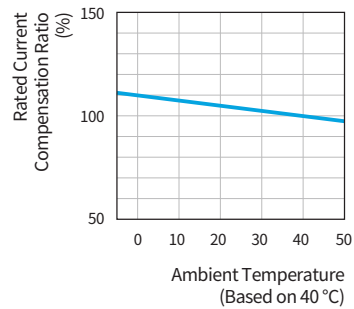

## Operation Characteristic Curve (HGP for Motor Protection)

HGP100 (2.5 ~ 100 A)

• HGP100

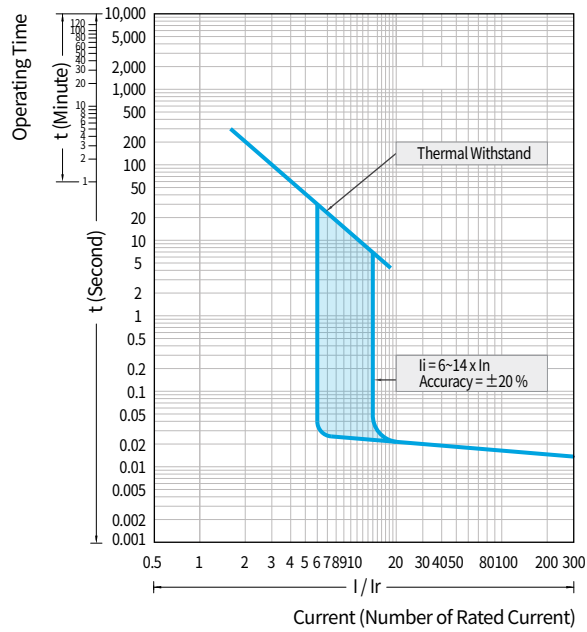

HGP250 (125 ~ 250 A)

• HGP250

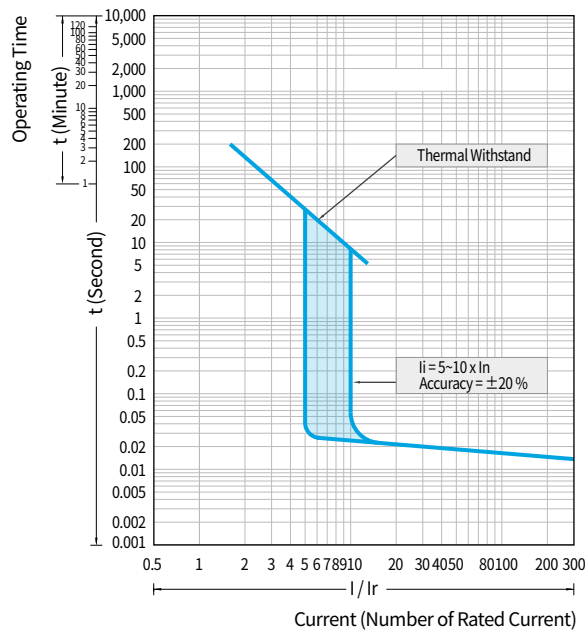

## Operation Characteristic Curve (HGP for Motor Protection)

HGP630 (300 ~ 630 A)

• HGP400, 630

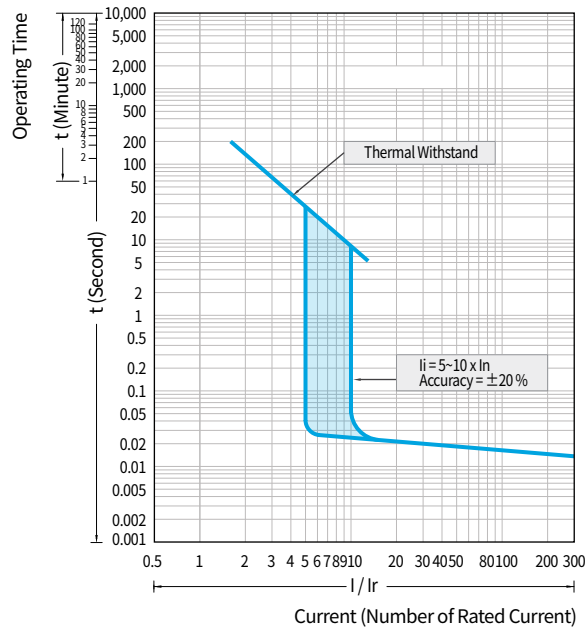

HGP800 (700 ~ 800 A)

• HGP800

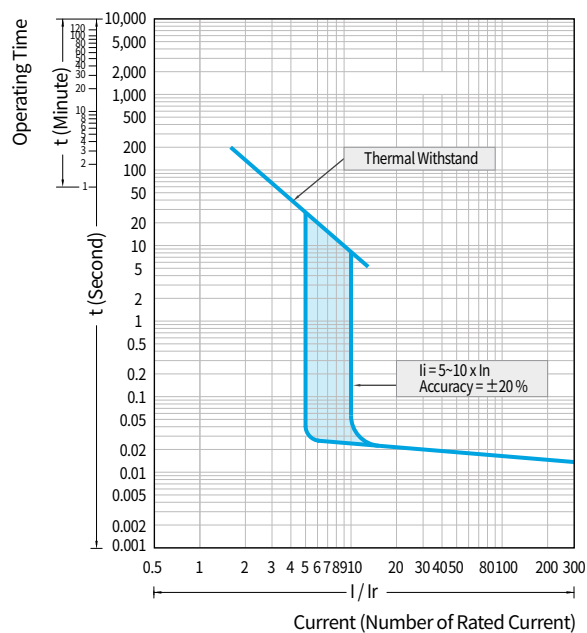



# Operation Characteristic Curve (HGP for Electronic)

## ETU-N Type

• HGP100, 160, 250, 400, 630, 800

- Long-Time Protection [L]
- Short-Time Protection [S]
- Instantaneous Protection [I]

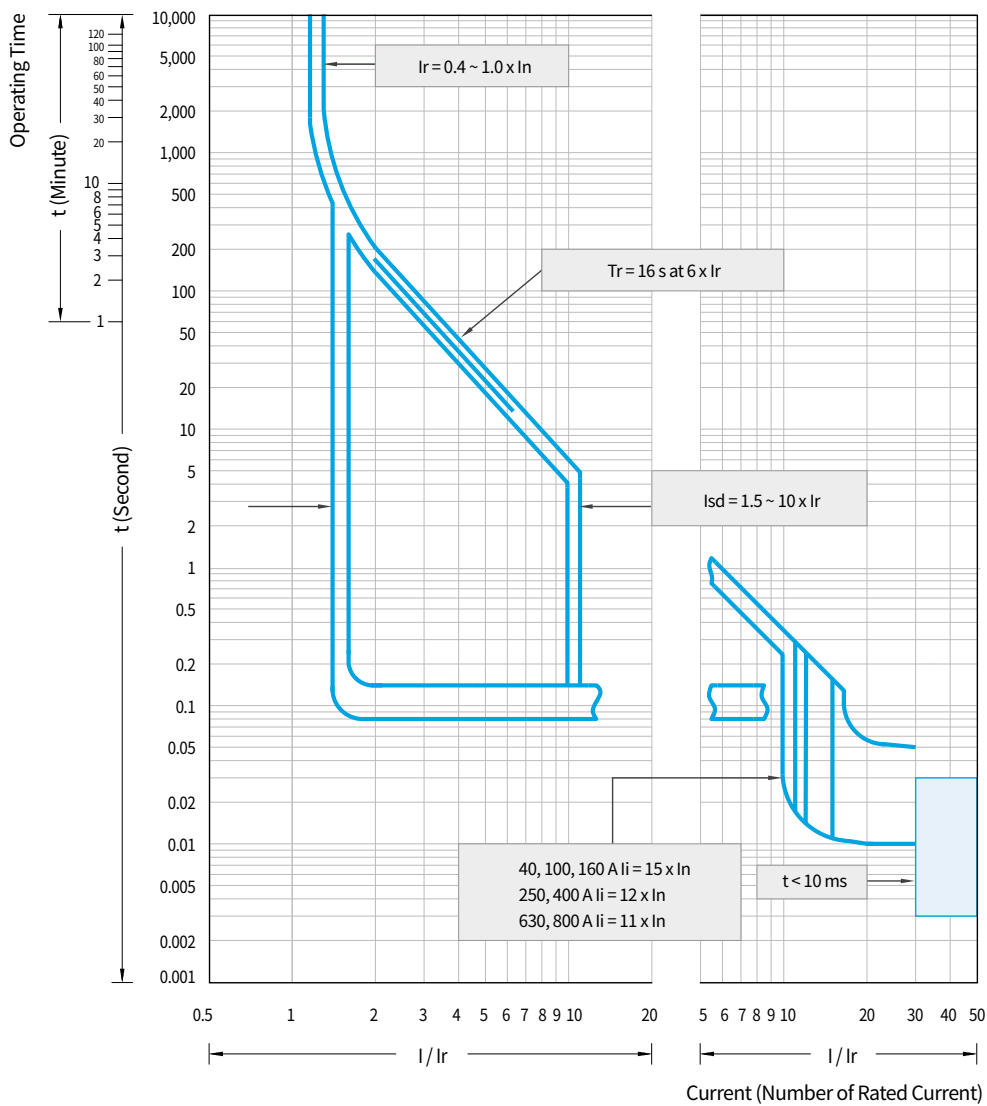

# Operation Characteristic Curve (HGP for Electronic)

ETU-D/A/E Type (L,S,I)

• HGP100, 160, 250, 400, 630, 800

- Long-Time Protection [L]
- Short-Time Protection [S]
- Instantaneous Protection [I]

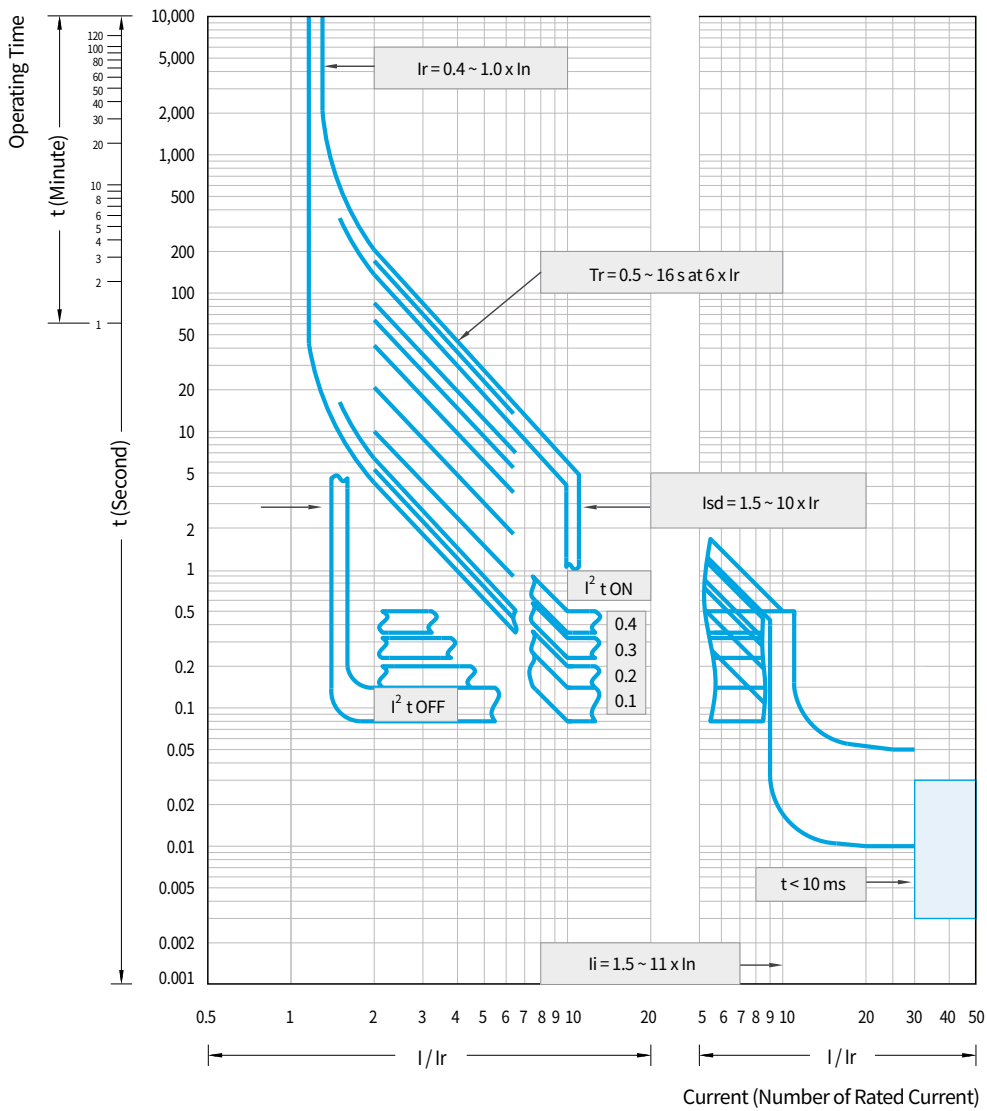

Technical Data

ETU-D/A/E Type (G)

• HGP100, 160, 250, 400, 630, 800

• Ground-Fault Protection [G]

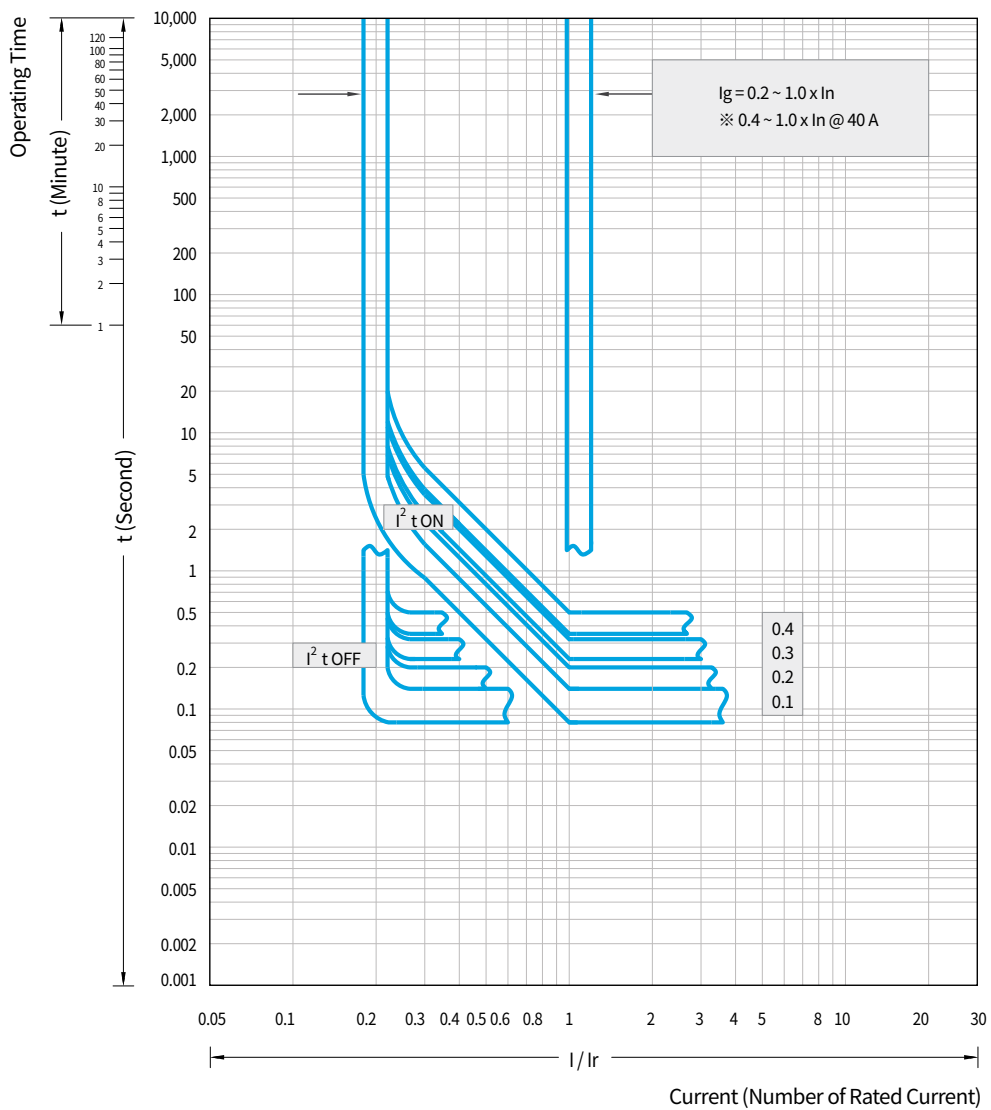

# Current & Energy-Limiting Characteristic Curve (HGP)

## Current-Limiting Characteristic Curve

• Based on 400/460 V

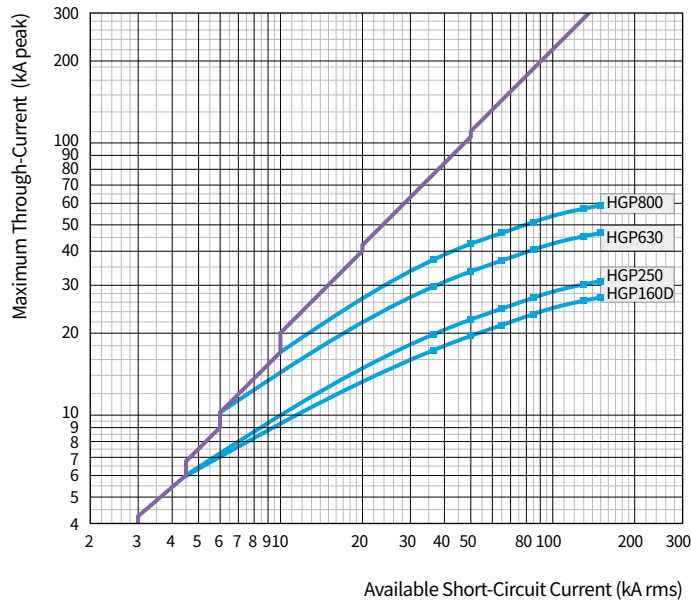

## Energy-Limiting Characteristic Curve

• Based on 400/460 V

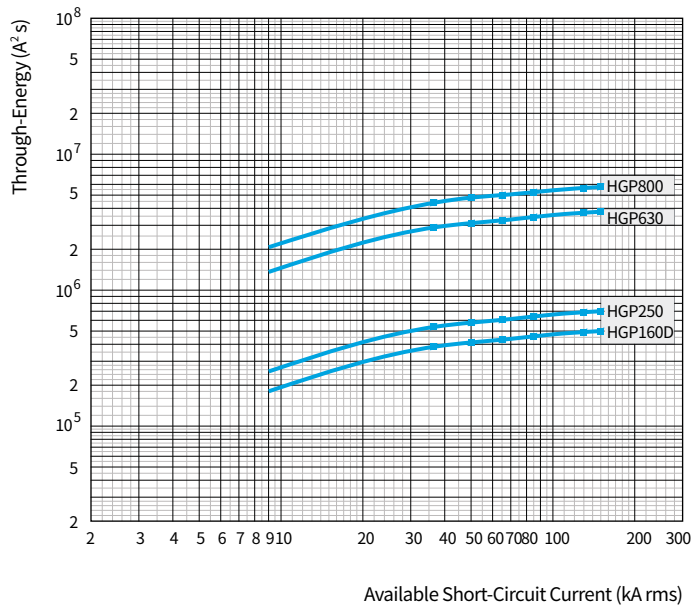

### Current-Limiting Characteristic Curve

Based on 480/500 V

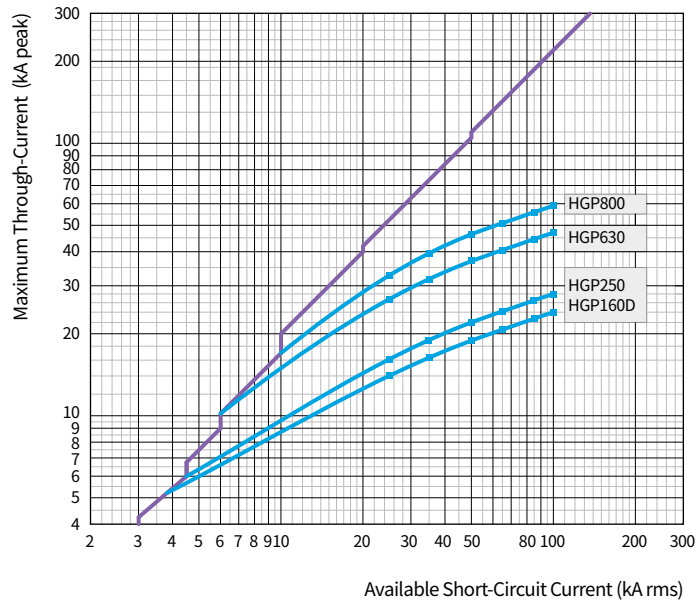

### Energy-Limiting Characteristic Curve

Based on 480/500 V

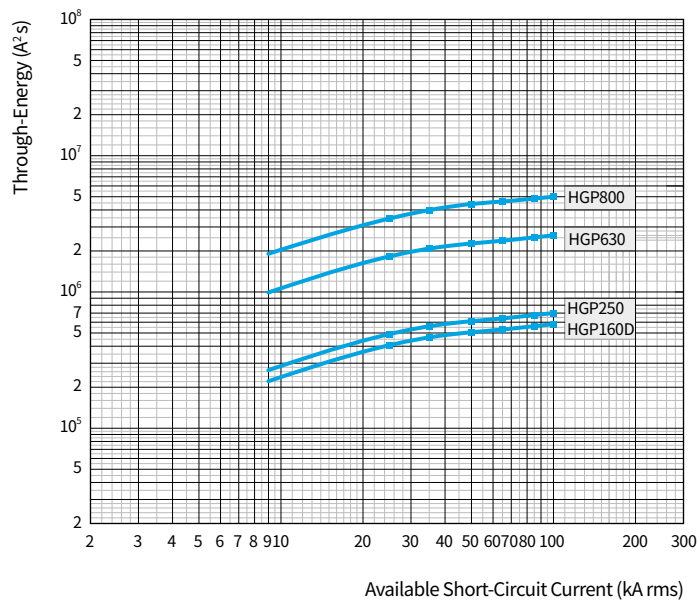

# Dimensions

## Front Connection HGM100

• HGM30, 50E/S, 60, 100

### External Dimension

Unit : mm

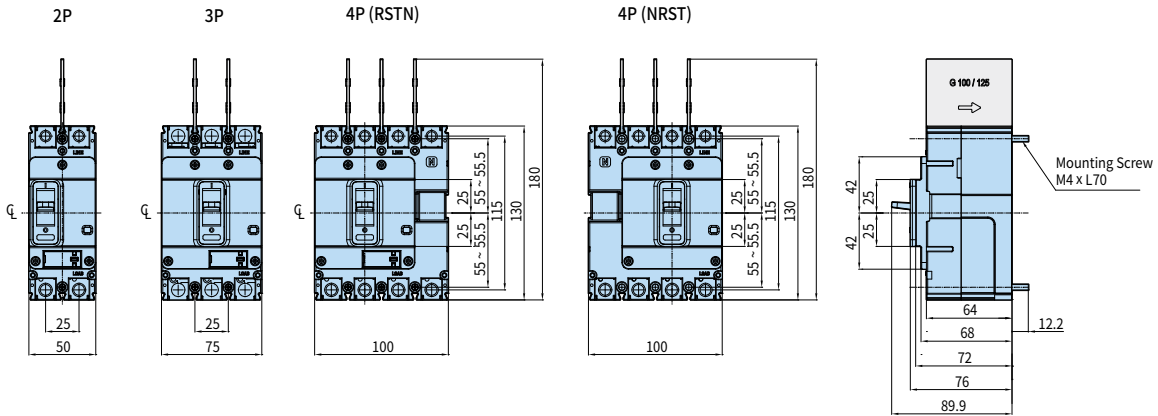

※ The insulation barrier at the line side is provided as default.

### Panel Installation Dimension

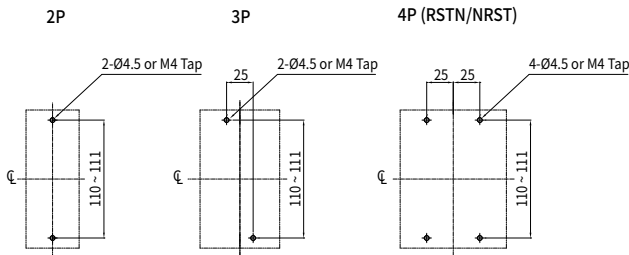

### Detail Drawing of Terminal Part/ Connecting Conductor

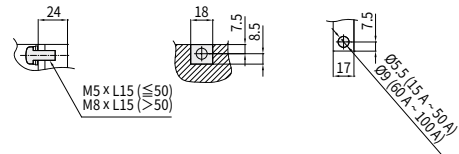

100 AF

Specification of Mounting Screw : M4 x L70 P/W

Specification of Terminal Mounting Screw : (Below 50 A) M5 x L15 S/W  
(Above 50 A) M8 x L15 S/W P/W

### Dimension of Panel Cover Cutting - Handle Exposure

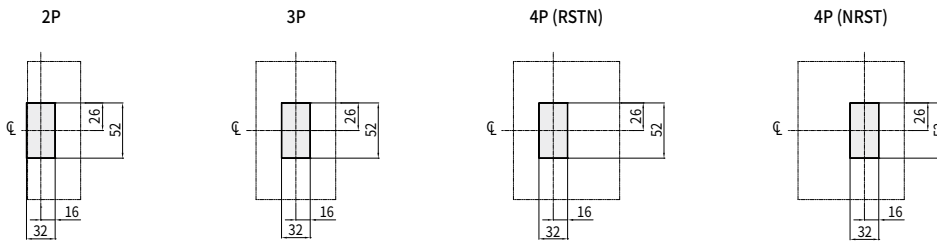

### Dimension of Panel Cover Cutting - Handle/Test Button Exposure

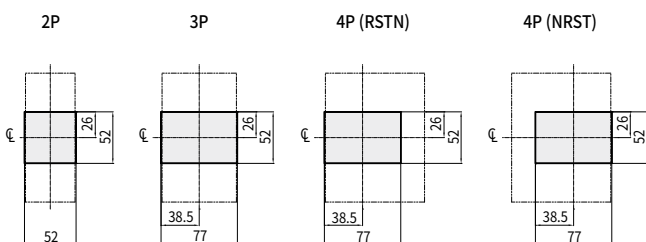

### Dimension of Panel Cover Cutting - Handle/Trip Unit Exposure

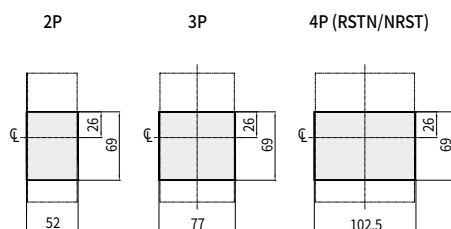

※ When installing the product in close contact, please consider tolerances for external dimensions.

## Front Connection HGM125

• HGM50H/L, 125

### External Dimension

Unit: mm

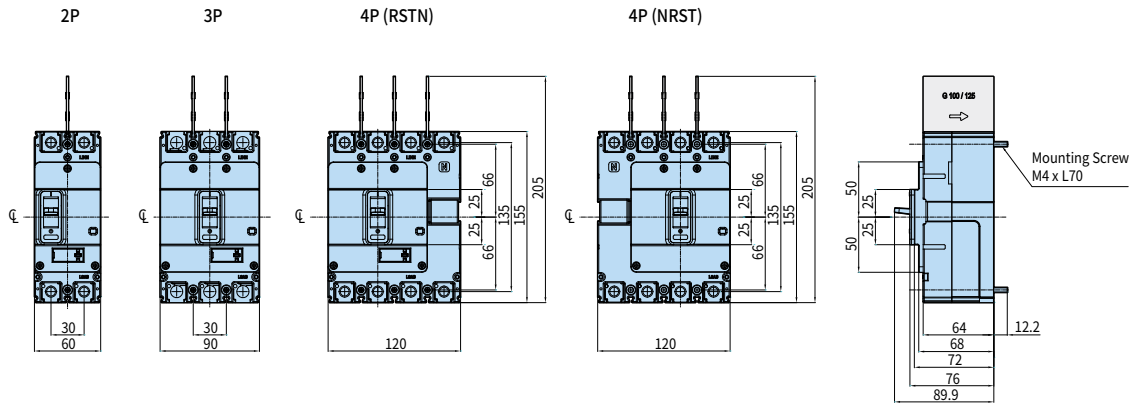

※ The insulation barrier at the line side is provided as default.

### Panel Installation Dimension

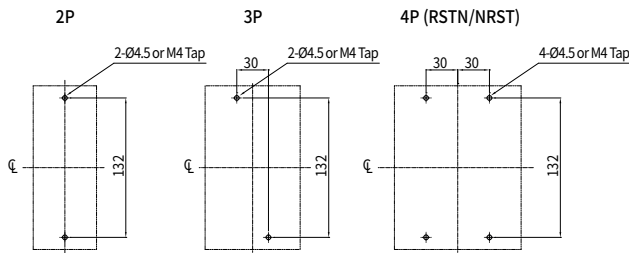

### Detail Drawing of Terminal Part/ Connecting Conductor

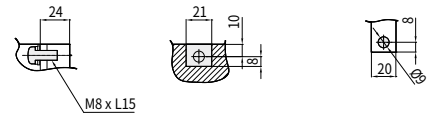

125 AF  
Specification of Mounting Screw : M4 x L70 P/W  
Specification of Terminal Mounting Screw : M8 x L15 S/W P/W

### Dimension of Panel Cover Cutting - Handle Exposure

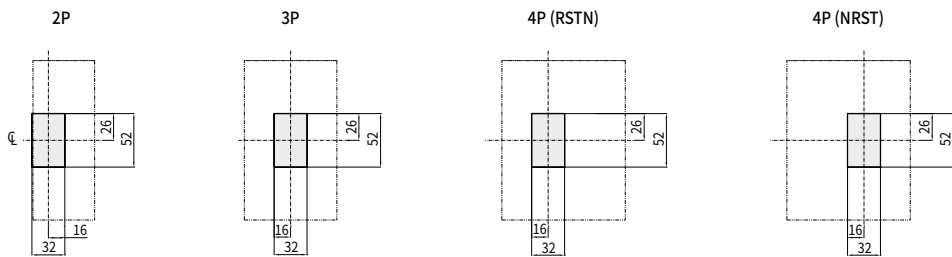

### Dimension of Panel Cover Cutting - Handle/Test Button Exposure

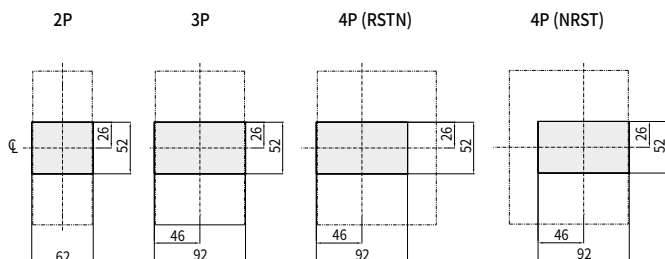

### Dimension of Panel Cover Cutting - Handle/Trip Unit Exposure

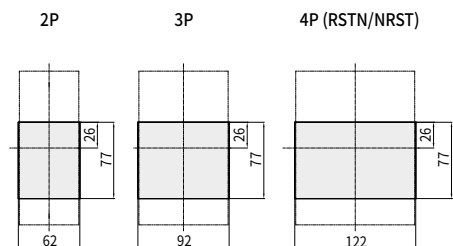

※ When installing the product in close contact, please consider tolerances for external dimensions.

# Dimensions

## Front Connection HGM250

• HGM160, 250

### External Dimension

Unit : mm

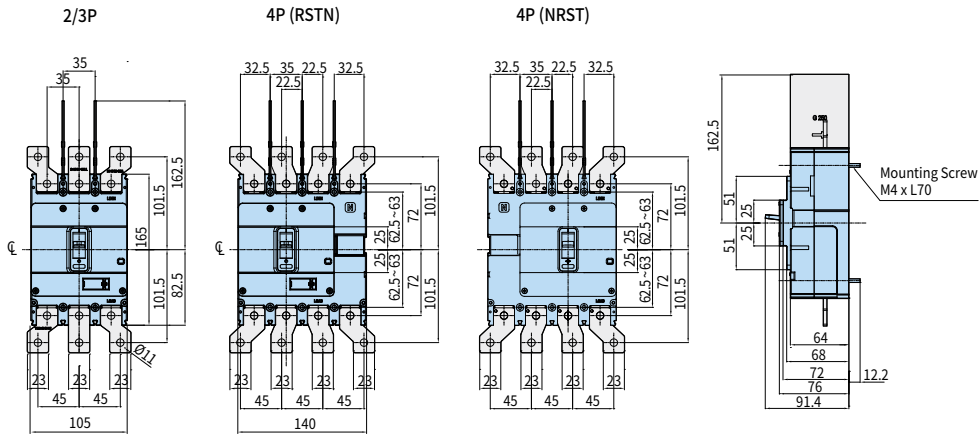

※ The insulation barrier at the line side is provided as default.

### Panel Installation Dimension

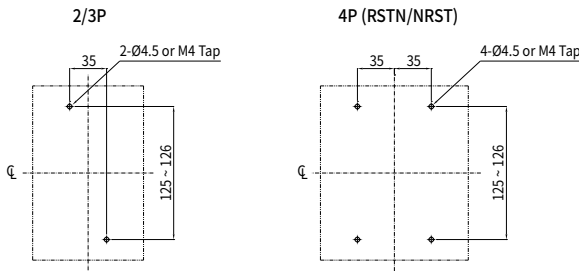

### Detail Drawing of Terminal Part/Connecting Conductor

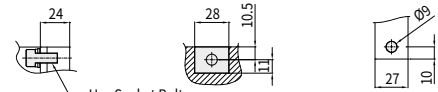

250 AF

Specification of Mounting Screw : M4 x L70 P/W

Specification of Terminal Mounting Screw : Hex Socket Bolt M8 x L18 W/W

### Dimension of Panel Cover Cutting - Handle Exposure

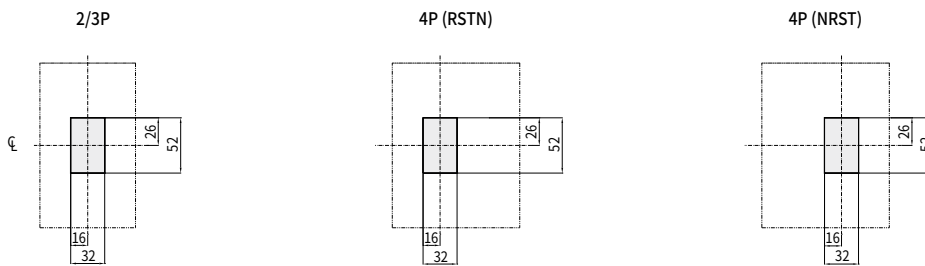

### Dimension of Panel Cover Cutting - Handle/Test Button Exposure

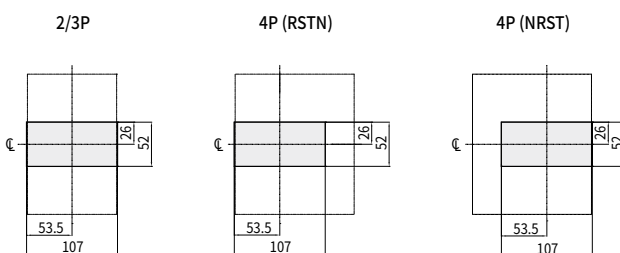

### Dimension of Panel Cover Cutting - Handle/Trip Unit Exposure

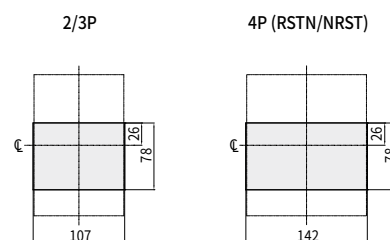

※ When installing the product in close contact, please consider tolerances for external dimensions.



## Front Connection HGM400

• HGM400

### External Dimension

Unit: mm

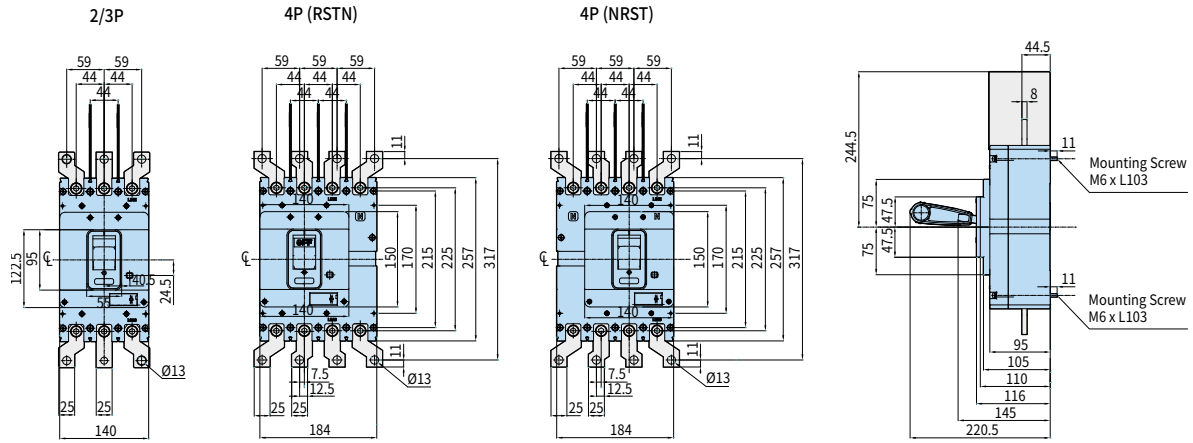

※ The insulation barrier at the line side is provided as default.

### Panel Installation Dimension

### Detail Drawing of Terminal Part/Connecting Conductor

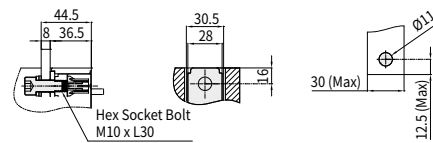
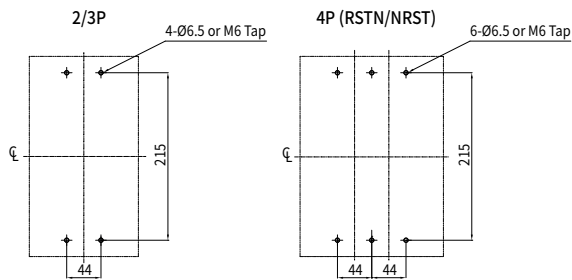

### Dimension of Panel Cover Cutting - Handle Exposure

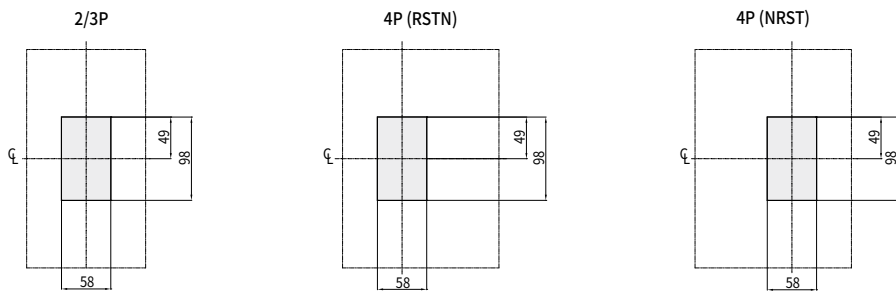

### Dimension of Panel Cover Cutting - Handle/Test Button Exposure

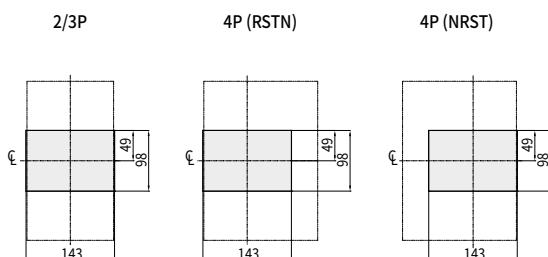

### Dimension of Panel Cover Cutting - Handle/Trip Unit Exposure

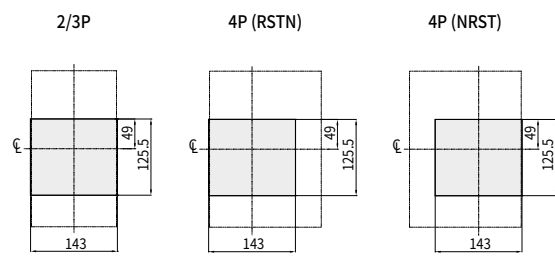

※ When installing the product in close contact, please consider tolerances for external dimensions.

# Dimensions

## Front Connection HGM800

• HGM630, 800

### External Dimension

Unit: mm

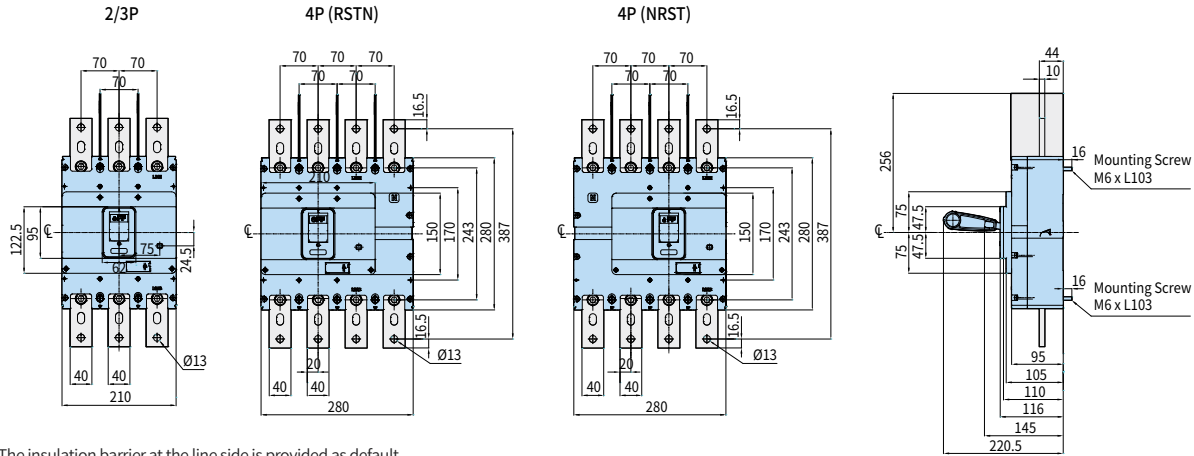

※ The insulation barrier at the line side is provided as default.

### Panel Installation Dimension

### Detail Drawing of Terminal Part/Connecting Conductor

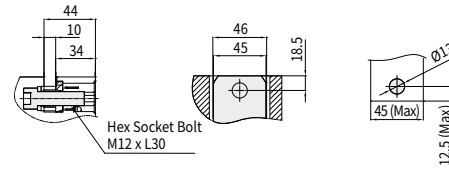
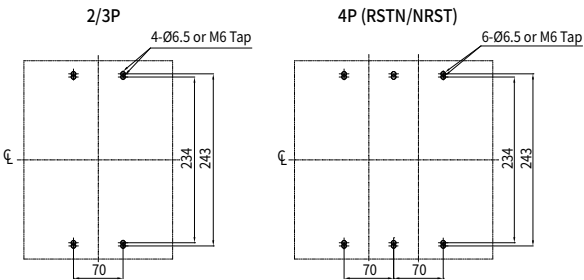

### Dimension of Panel Cover Cutting - Handle Exposure

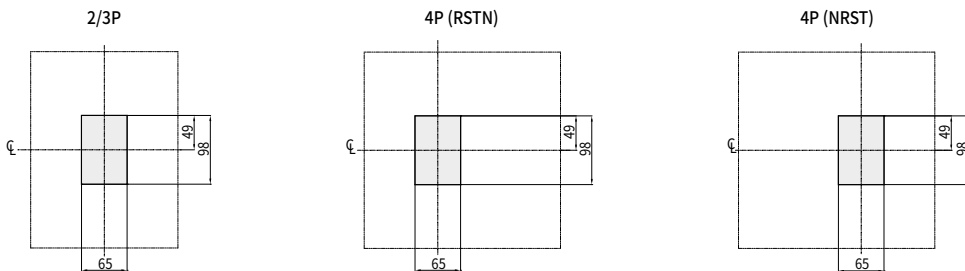

### Dimension of Panel Cover Cutting - Handle/Test Button Exposure

### Dimension of Panel Cover Cutting - Handle/Trip Unit Exposure

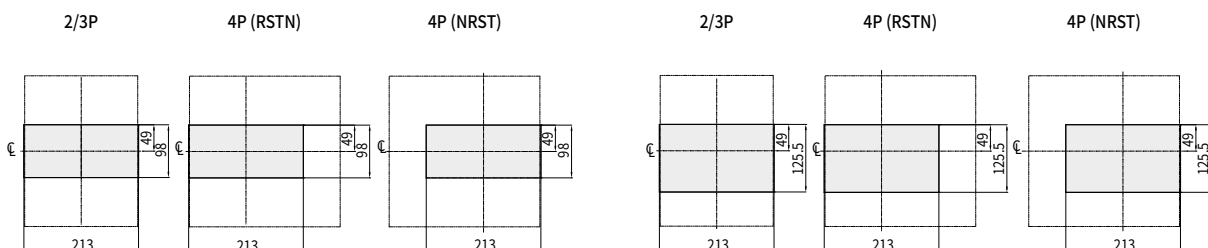

※ When installing the product in close contact, please consider tolerances for external dimensions.

## Front Connection HGE100

• HGE30, 50E/S, 60, 100

### External Dimension

Unit: mm

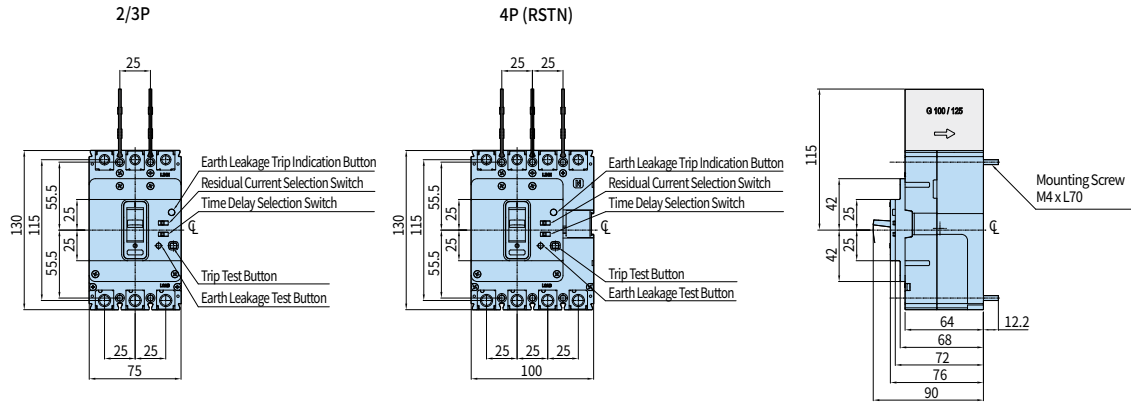

※ The insulation barrier at the line side is provided as default.

### Panel Installation Dimension

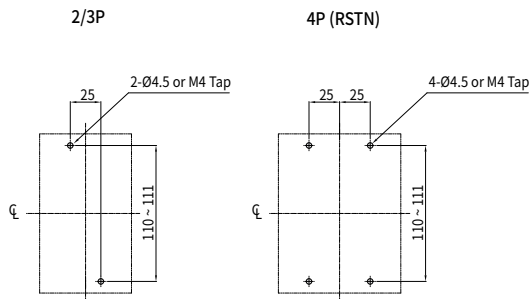

### Detail Drawing of Terminal Part/Connecting Conductor

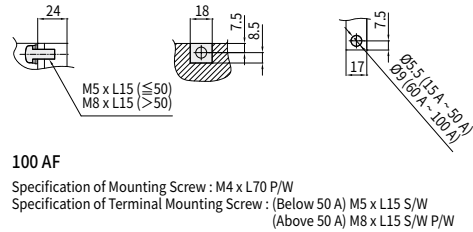

### Dimension of Panel Cover Cutting - Handle Exposure

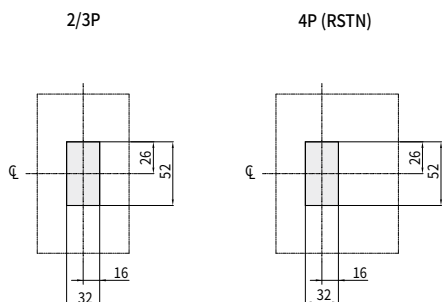

### Dimension of Panel Cover Cutting - Handle/Test Button Exposure

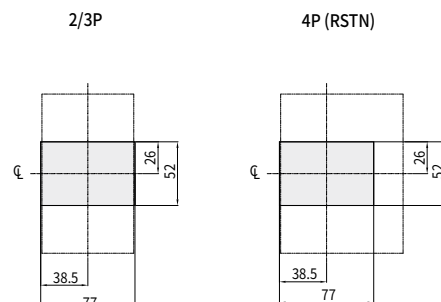

※ When installing the product in close contact, please consider tolerances for external dimensions.

# Dimensions

## Front Connection HGE125

• HGE50H/L, 125

### External Dimension

Unit : mm

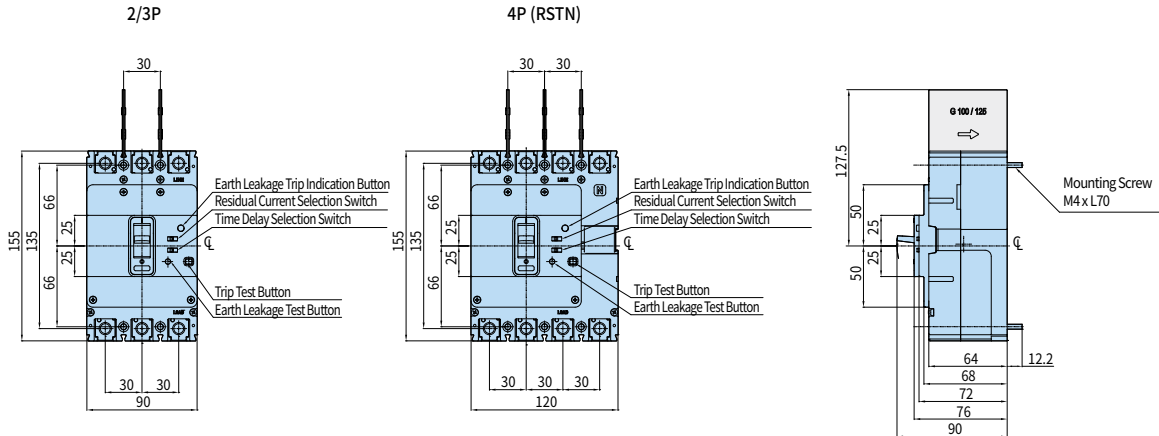

※ The insulation barrier at the line side is provided as default.

### Panel Installation Dimension

### Detail Drawing of Terminal Part/Connecting Conductor

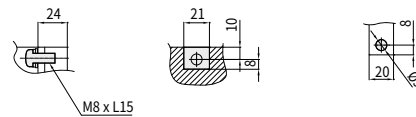
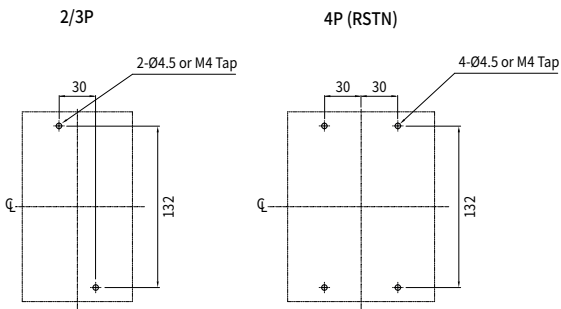

125 AF  
 Specification of Mounting Screw : M4 x L70 P/W  
 Specification of Terminal Mounting Screw : M8 x L15 S/W P/W

### Dimension of Panel Cover Cutting - Handle Exposure

### Dimension of Panel Cover Cutting - Handle/Test Button Exposure

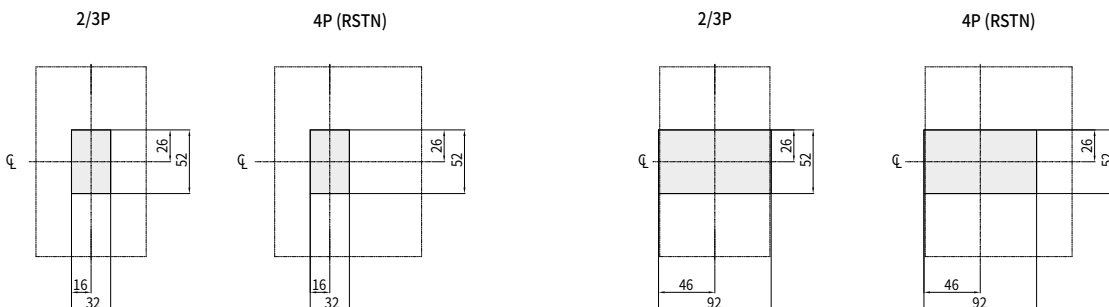

※ When installing the product in close contact, please consider tolerances for external dimensions.

## Front Connection HGE250

• HGE160, 250

### External Dimension

Unit: mm

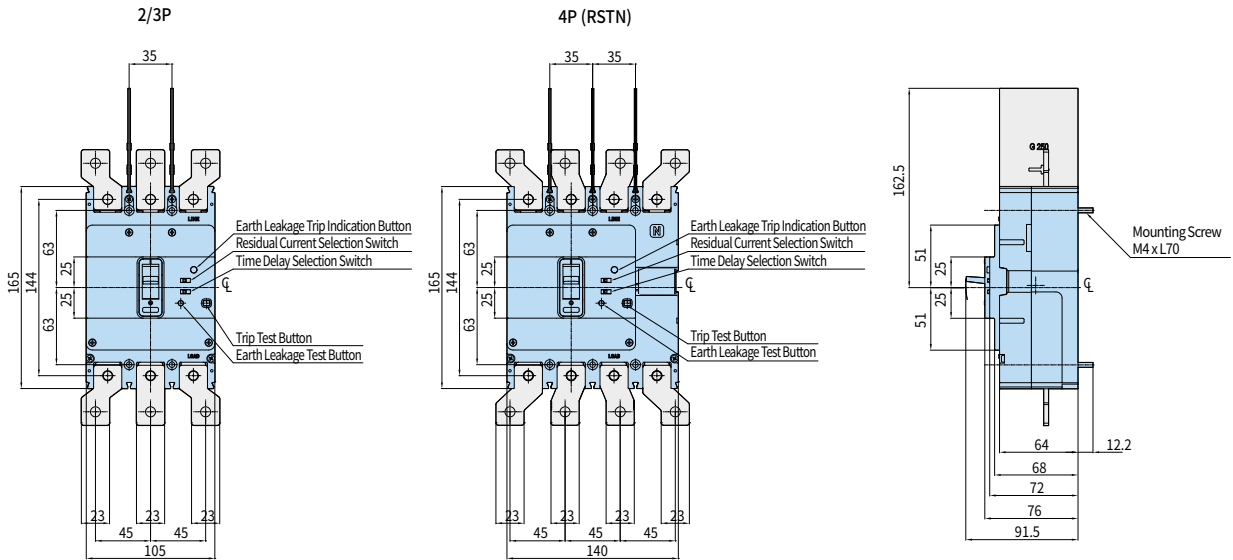

※ The insulation barrier at the line side is provided as default.

### Panel Installation Dimension

### Detail Drawing of Terminal Part/Connecting Conductor

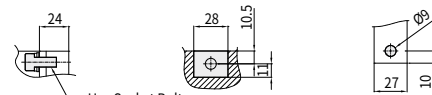
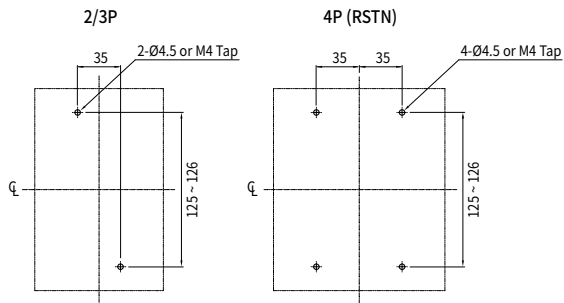

250 AF

Specification of Mounting Screw : M4 x L70 P/W

Specification of Terminal Mounting Screw : Hex Socket Bolt M8 x L18 W/W

### Dimension of Panel Cover Cutting - Handle Exposure

### Dimension of Panel Cover Cutting - Handle/Test Button Exposure

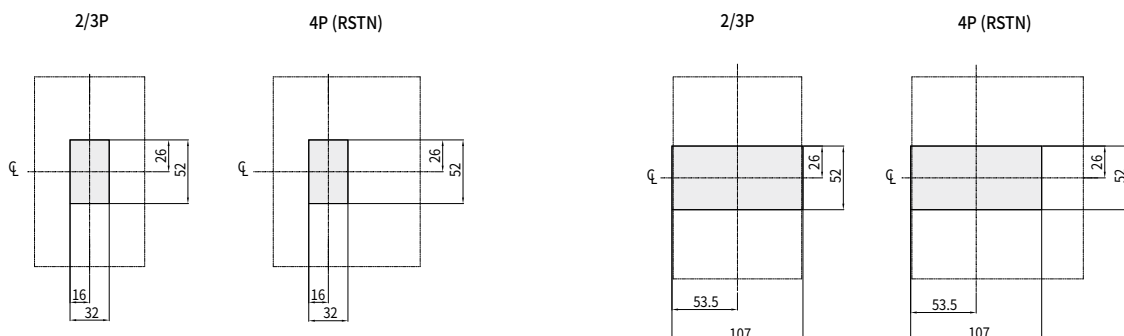

※ When installing the product in close contact, please consider tolerances for external dimensions.

# Dimensions

## Front Connection HGE400

• HGE400

### External Dimension

Unit : mm

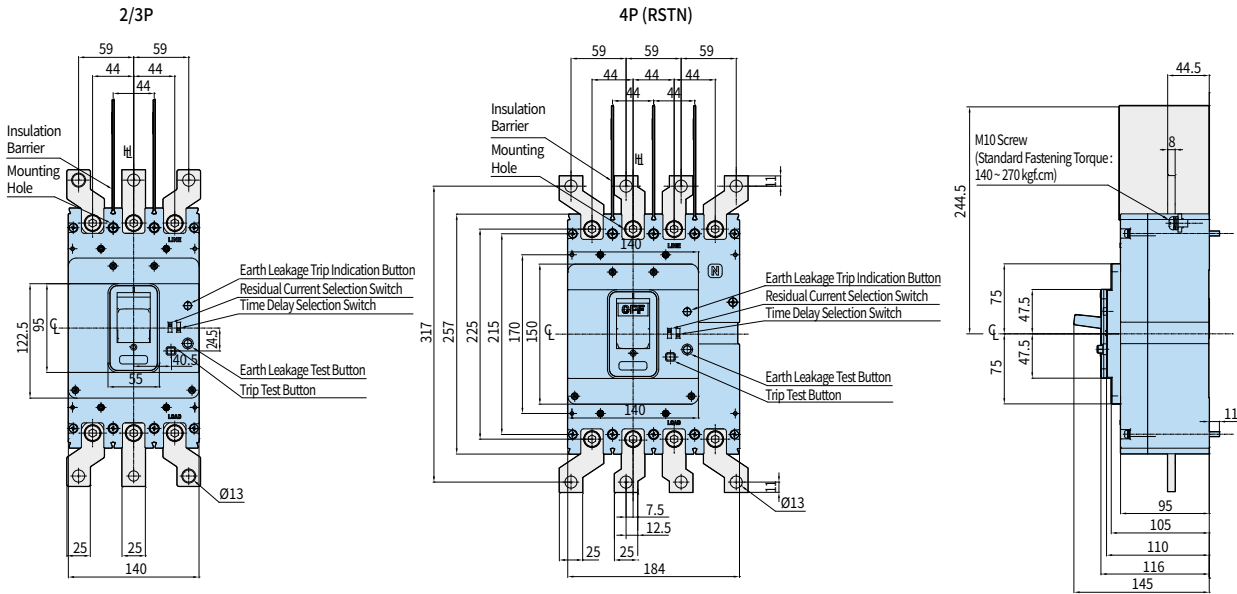

※ The insulation barrier at the line side is provided as standard product.

### Panel Installation Dimension

### Detail Drawing of Terminal Part/Connecting Conductor

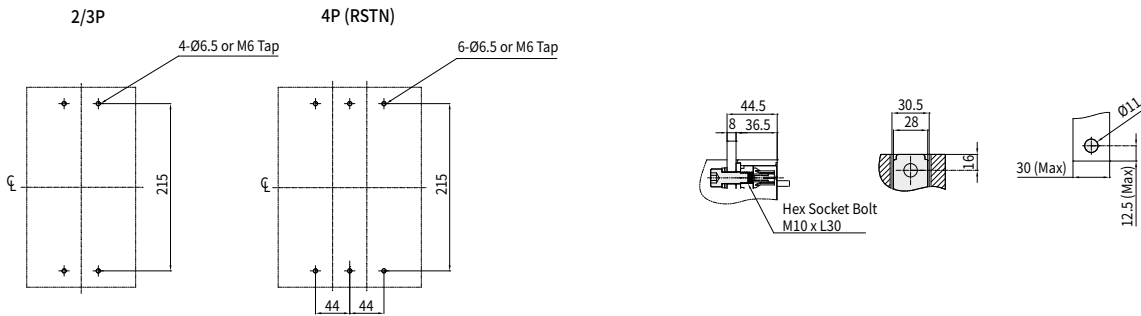

### Dimension of Panel Cover Cutting

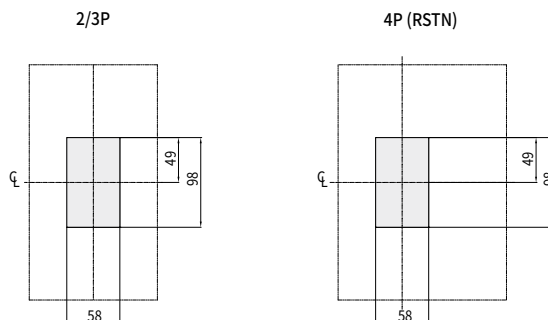

※ When installing the product in close contact, please consider tolerances for external dimensions.

## Front Connection HGE800

• HGE630, 800

### External Dimension

Unit: mm

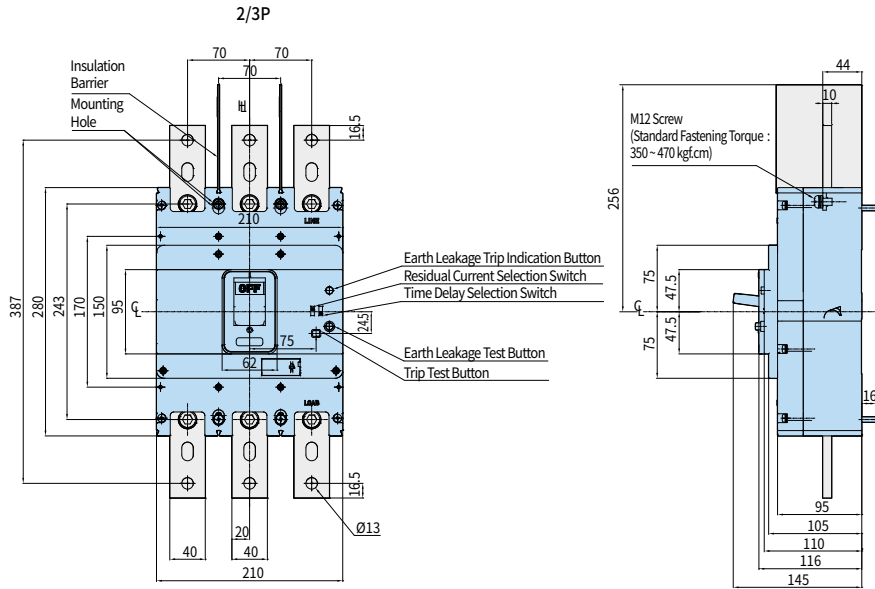

※ The insulation barrier at the line side is provided as standard product.

### Panel Installation Dimension

### Detail Drawing of Terminal Part/Connecting Conductor

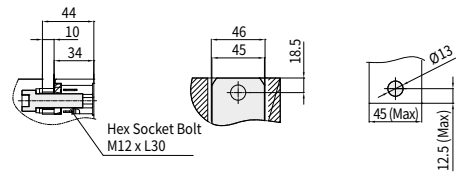
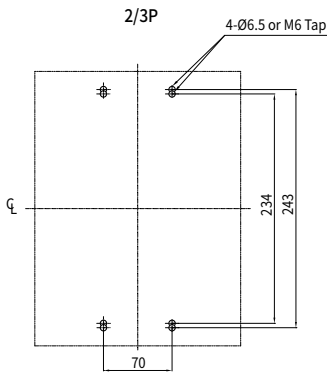

### Dimension of Panel Cover Cutting

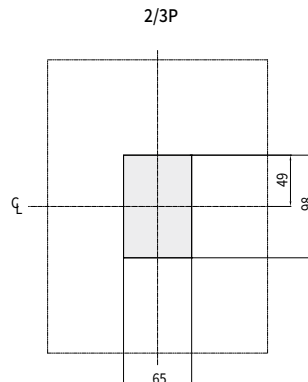

※ When installing the product in close contact, please consider tolerances for external dimensions.

# Dimensions

## Front Connection HGP160D

• HGP50D, 125D, 160D

### External Dimension

Unit : mm

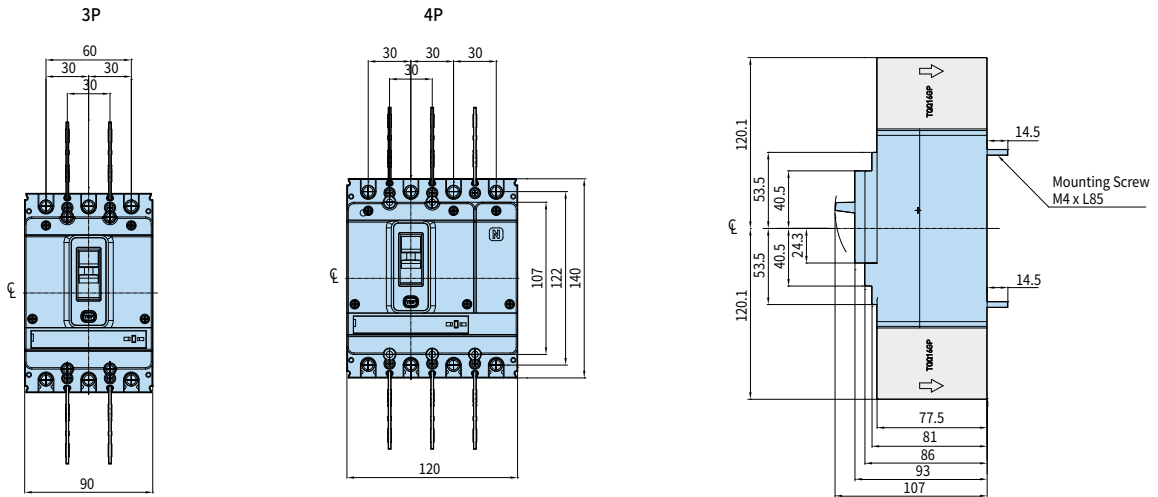

### Panel Installation Dimension

### Detail Drawing of Terminal Part/Connecting Conductor

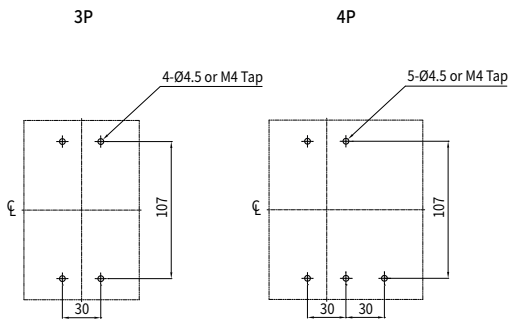

#### Terminal Part

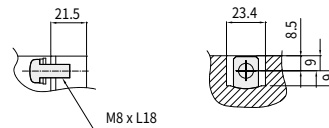

#### Connecting Conductor



### Dimension of Panel Cover Cutting

#### Handle/Test Button Exposure

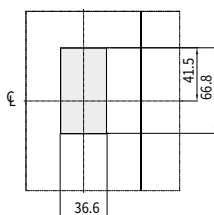

#### Handle/Trip Unit Exposure

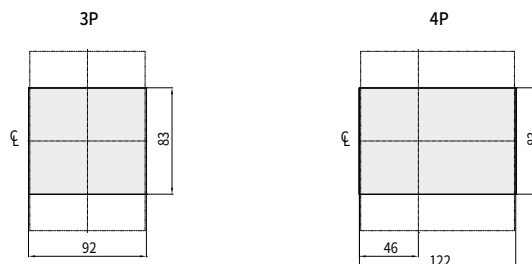

※ When installing the product in close contact, please consider tolerances for external dimensions.



## Front Connection HGP250

• HGP100, 160, 250

### External Dimension

Unit: mm

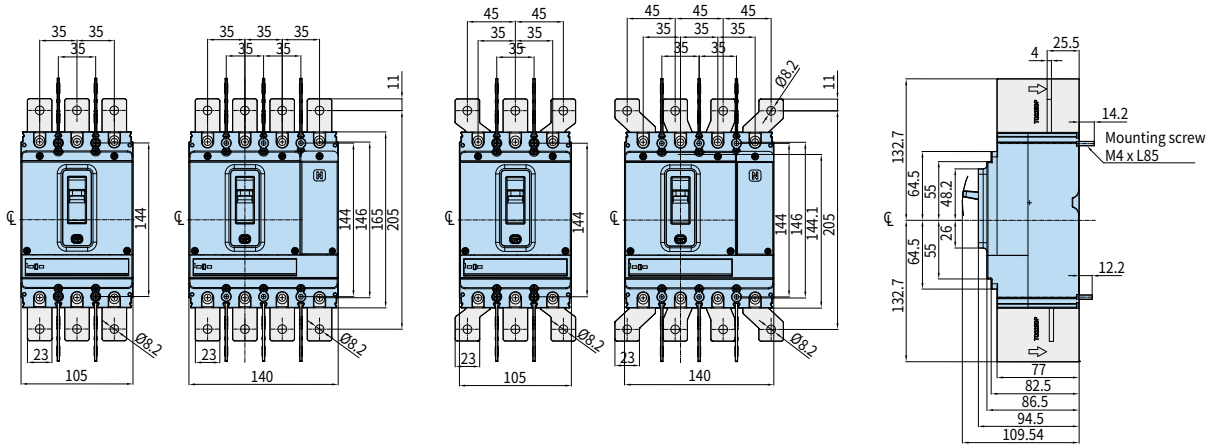

### Panel Installation Dimension

### Detail Drawing of Terminal Part/Connecting Conductor

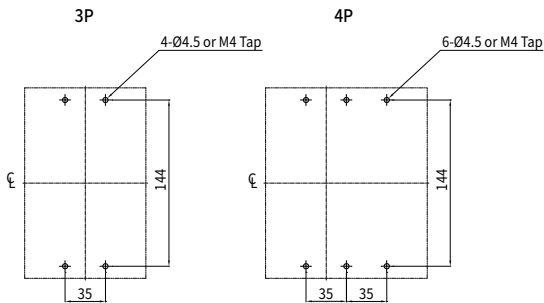

#### Terminal Part

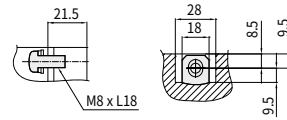

#### Connecting Conductor

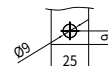

※ Screw Applied : M4×L85 S/W (For Circuit Breaker Mounting),  
M8×L18 S/W P/W (For Terminal Mounting)

### Dimension of Panel Cover Cutting

#### Handle/Test Button Exposure

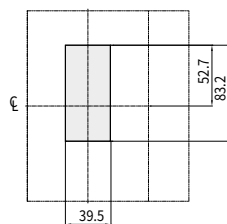

#### Handle/Trip Unit Exposure

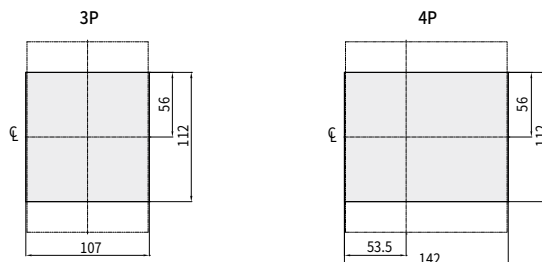

※ When installing the product in close contact, please consider tolerances for external dimensions.

# Dimensions

## Front Connection HGP630

• HGP400, 630

### External Dimension

Unit : mm

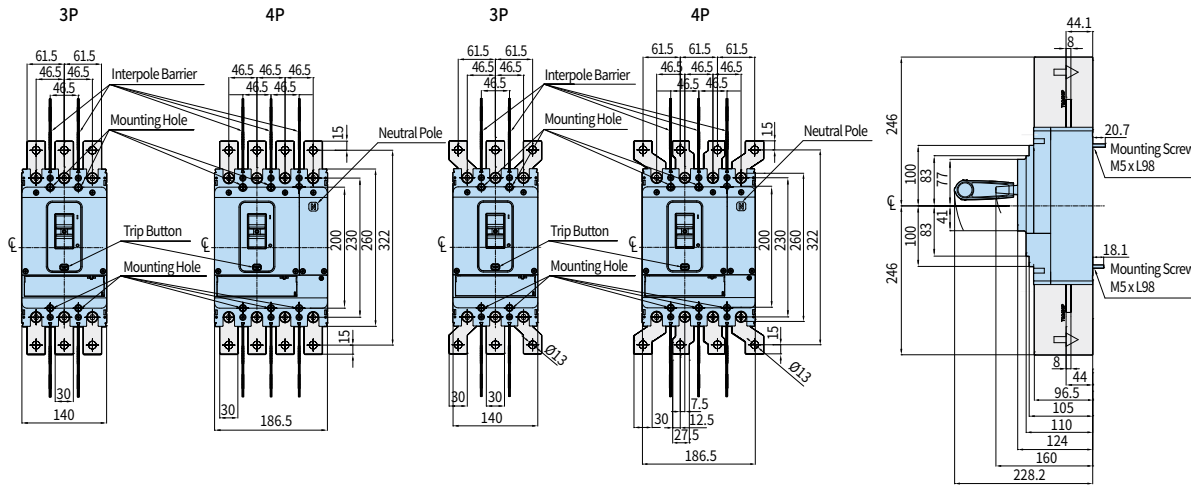

### Panel Installation Dimension

### Detail Drawing of Terminal Part/Connecting Conductor

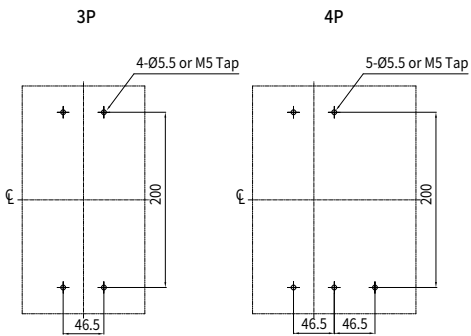

#### Terminal Part

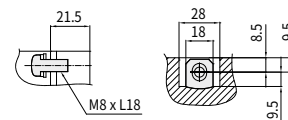

#### Connecting Conductor

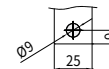

### Dimension of Panel Cover Cutting

#### Handle/Test Button Exposure

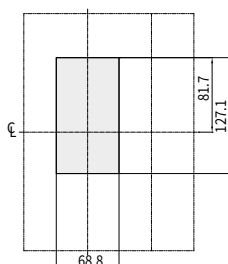

#### Handle/Trip Unit Exposure

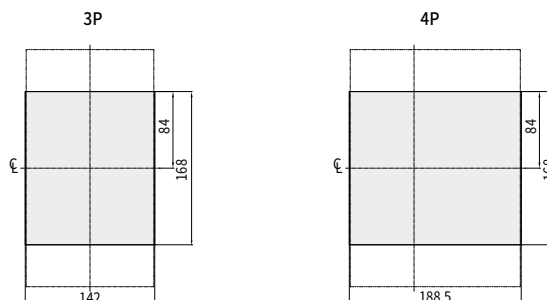

※ When installing the product in close contact, please consider tolerances for external dimensions.

## Front Connection HGP800

• HGP800

### External Dimension

Unit: mm

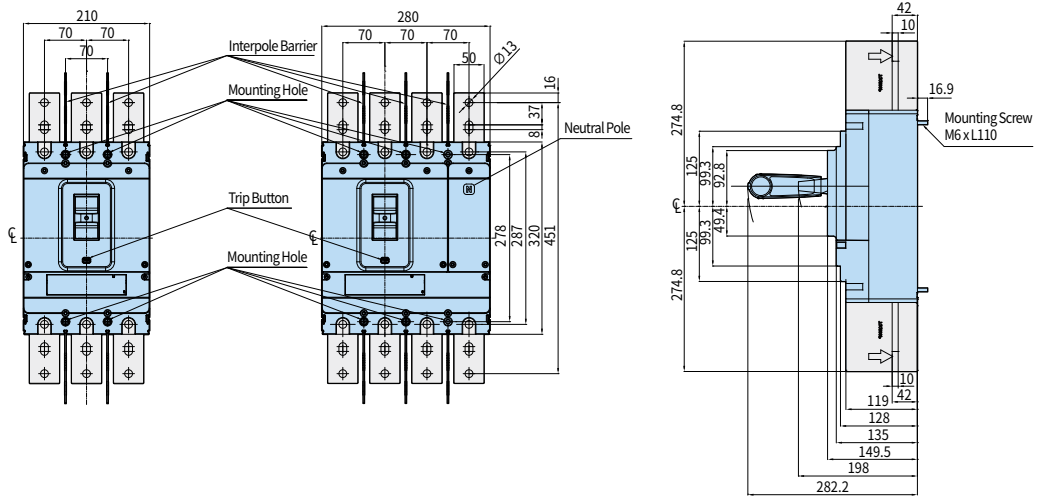

### Panel Installation Dimension

### Detail Drawing of Terminal Part/Connecting Conductor

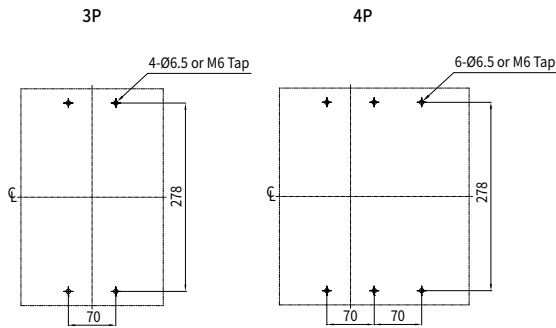

#### Terminal Part

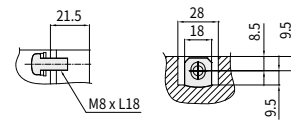

#### Connecting Conductor

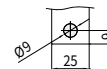

### Dimension of Panel Cover Cutting

#### Handle/Test Button Exposure

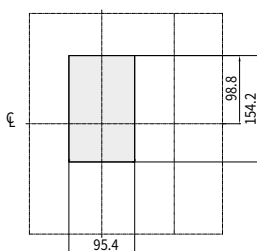

#### Handle/Trip Unit Exposure

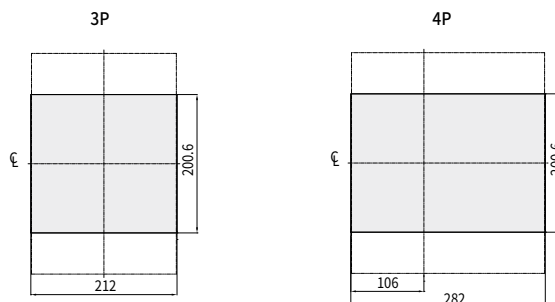

※ When installing the product in close contact, please consider tolerances for external dimensions.

# Dimensions

## Rear Connection (Flat Type) HGM100

• HGM30, 50E/S, 60, 100

### External Dimension

Unit: mm

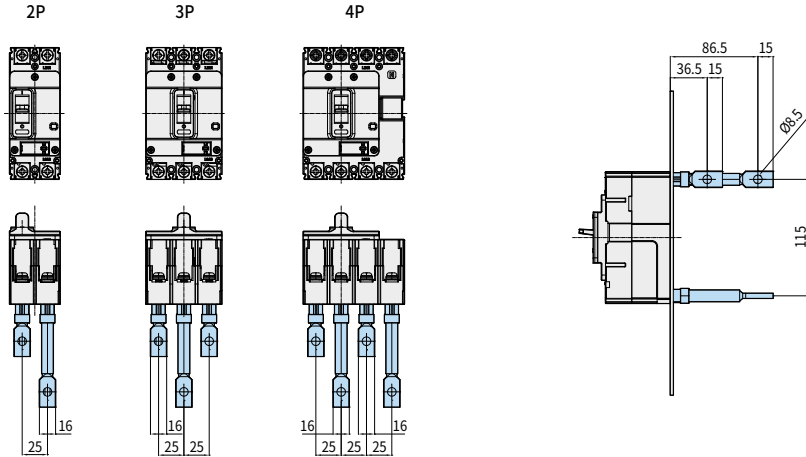

### Panel Installation Dimension

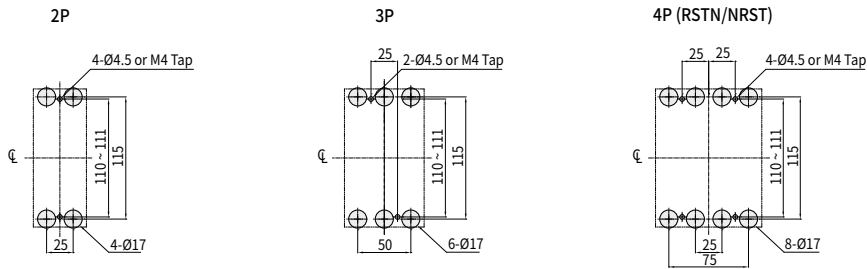

### Dimension of Panel Cover Cutting - Handle/Test Button Exposure

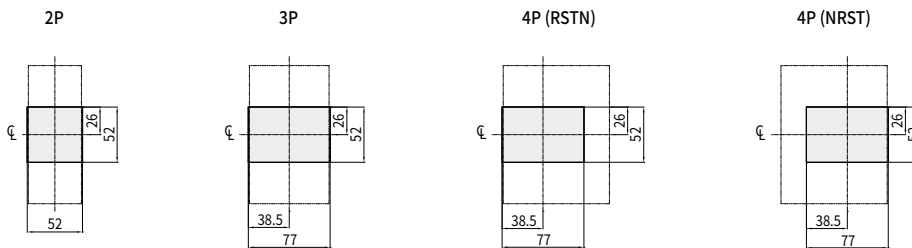

### Dimension of Panel Cover Cutting - Handle/Trip Unit Exposure

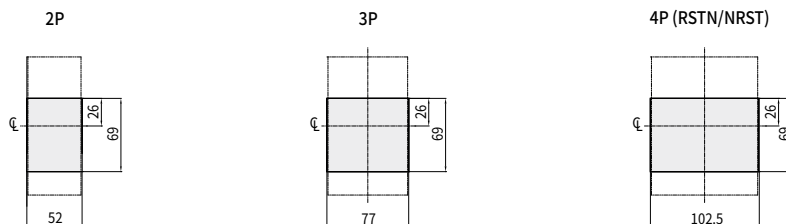

※ When assembling the RCT, remove the back barrier beforehand.  
 ※ When installing the product in close contact, please consider tolerances for external dimensions.

## Rear Connection (Flat Type) HGM125

• HGM50H/L, 125

### External Dimension

Unit: mm

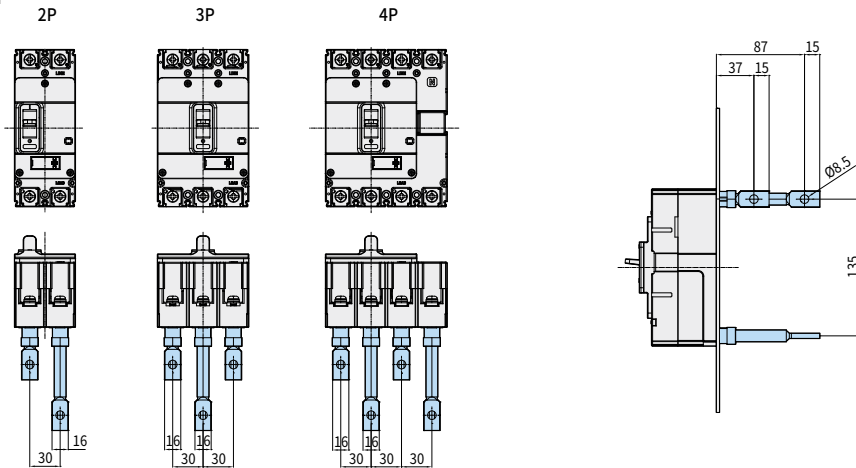

### Panel Installation Dimension

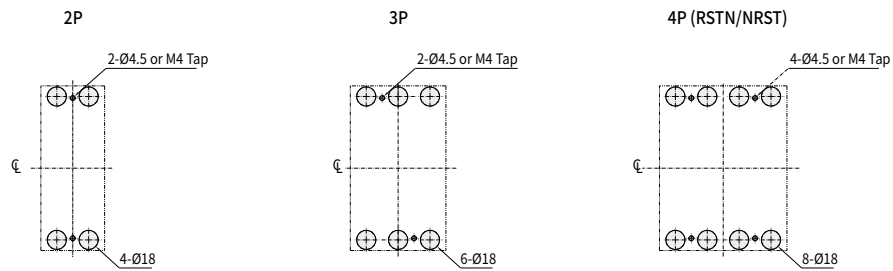

### Dimension of Panel Cover Cutting - Handle/Test Button Exposure

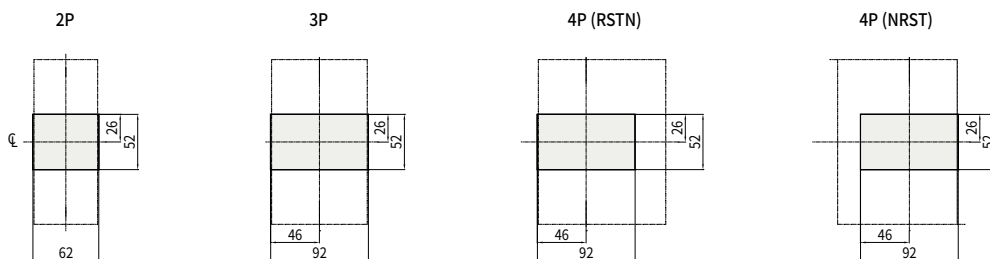

### Dimension of Panel Cover Cutting - Handle/Trip Unit Exposure

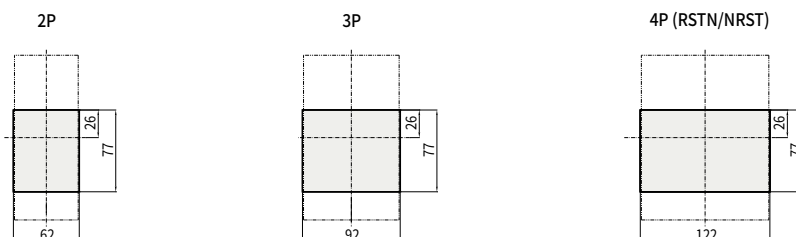

※ When assembling the RCT, remove the back barrier beforehand.  
 ※ When installing the product in close contact, please consider tolerances for external dimensions.

# Dimensions

## Rear Connection (Flat Type) HGM250

• HGM160, 250

### External Dimension

Unit: mm

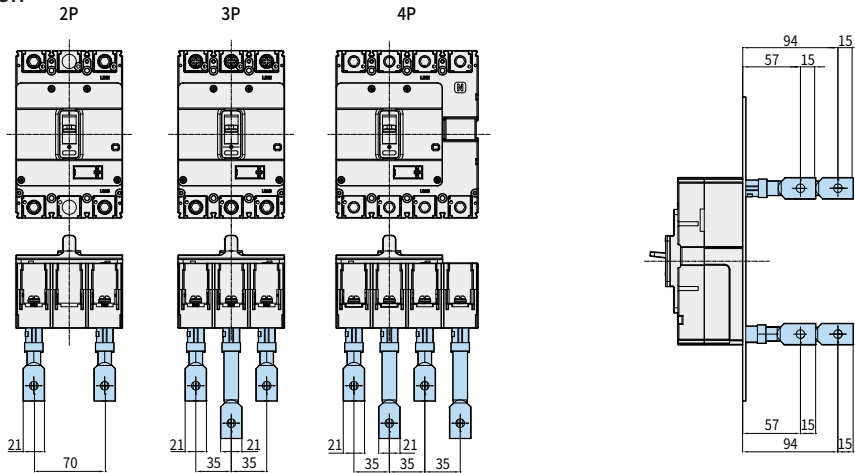

### Panel Installation Dimension

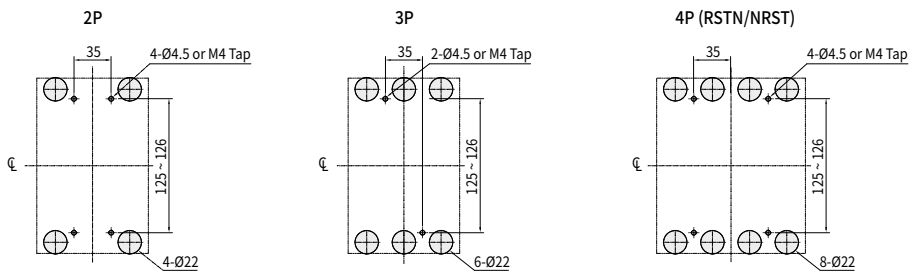

### Dimension of Panel Cover Cutting - Handle/Test Button Exposure

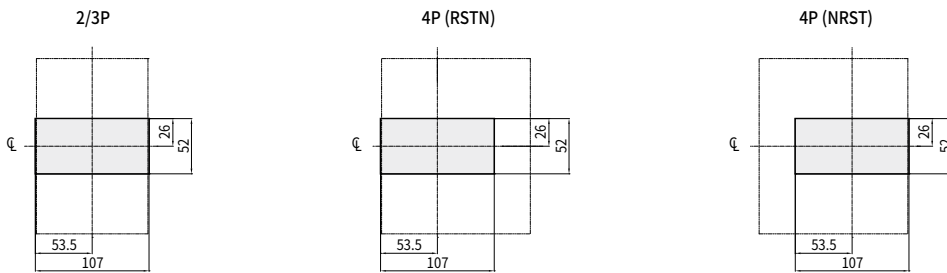

### Dimension of Panel Cover Cutting - Handle/Trip Unit Exposure

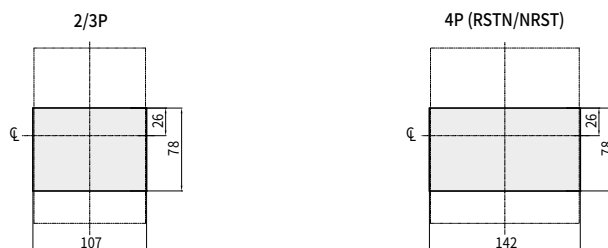

※ When assembling the RCT, remove the back barrier beforehand.  
 ※ When installing the product in close contact, please consider tolerances for external dimensions.

## Rear Connection (Flat Type) HGM400

• HGM400

### External Dimension

Unit: mm

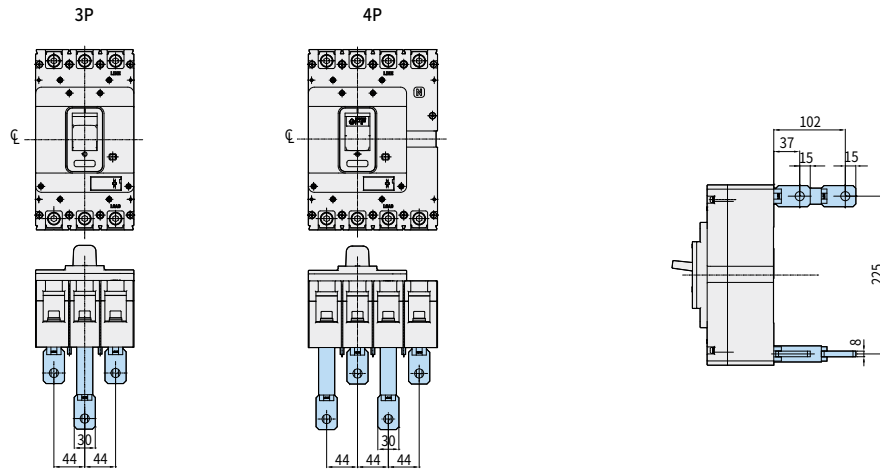

### Panel Installation Dimension

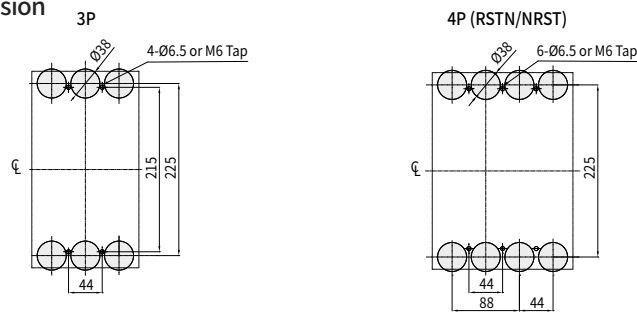

### Dimension of Panel Cover Cutting - Handle/Test Button Exposure

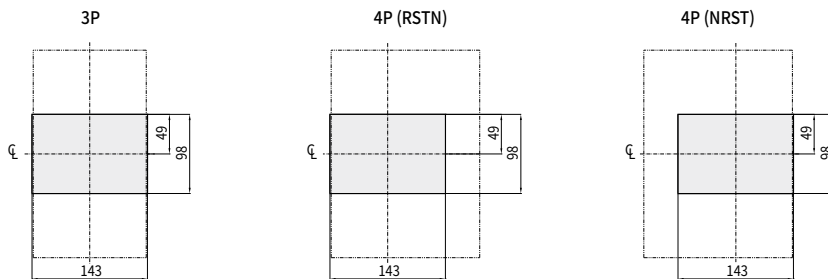

### Dimension of Panel Cover Cutting - Handle/Trip Unit Exposure

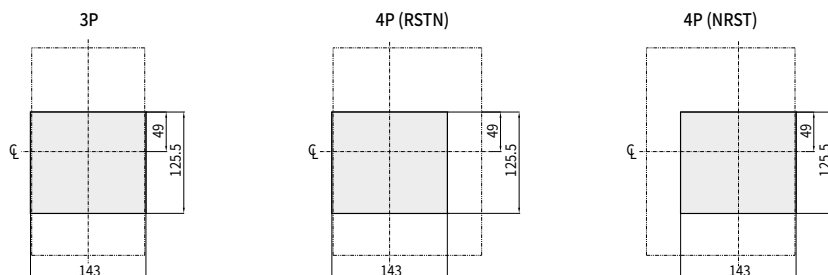

※ When assembling the RCT, remove the back barrier beforehand.  
 ※ When installing the product in close contact, please consider tolerances for external dimensions.

# Dimensions

## Rear Connection (Flat Type) HGM800

• HGM630, 800

### External Dimension

Unit : mm

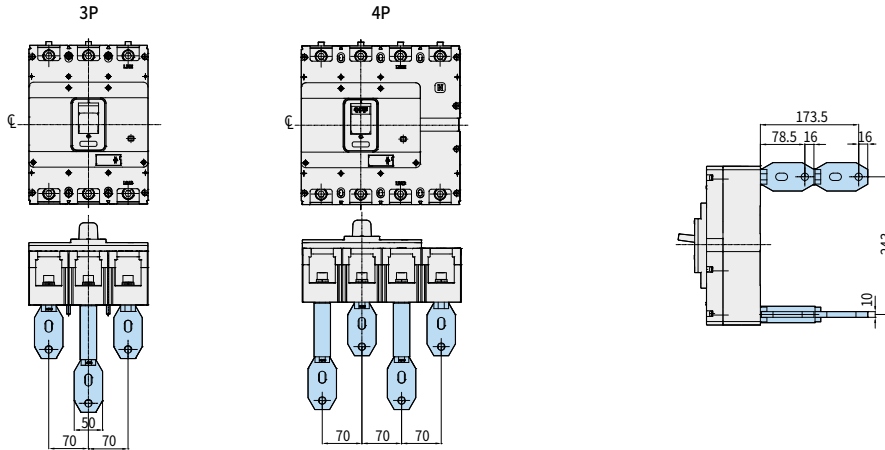

### Panel Installation Dimension

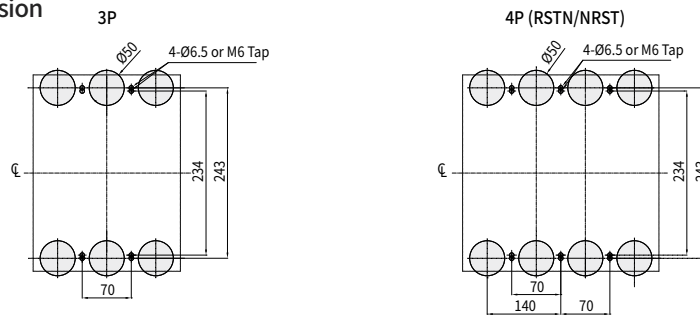

### Dimension of Panel Cover Cutting - Handle/Test Button Exposure

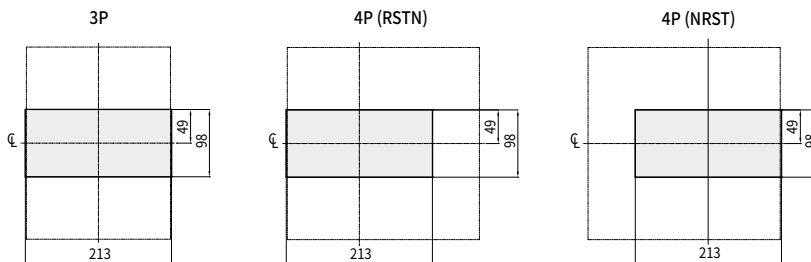

### Dimension of Panel Cover Cutting - Handle/Trip Unit Exposure

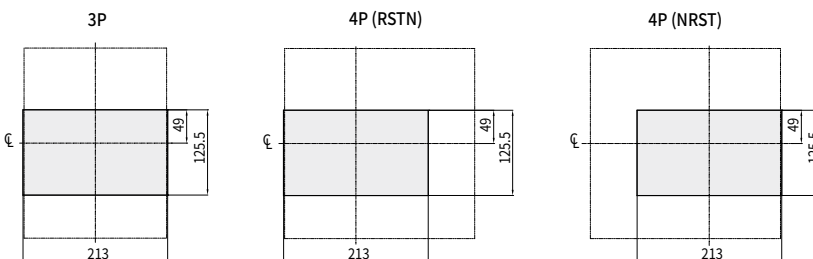

※ When assembling the RCT, remove the back barrier beforehand.  
 ※ When installing the product in close contact, please consider tolerances for external dimensions.



## Rear Connection (Rear Type) HGP160D

• HGP50D, 125D, 160D

### External Dimension

Unit: mm

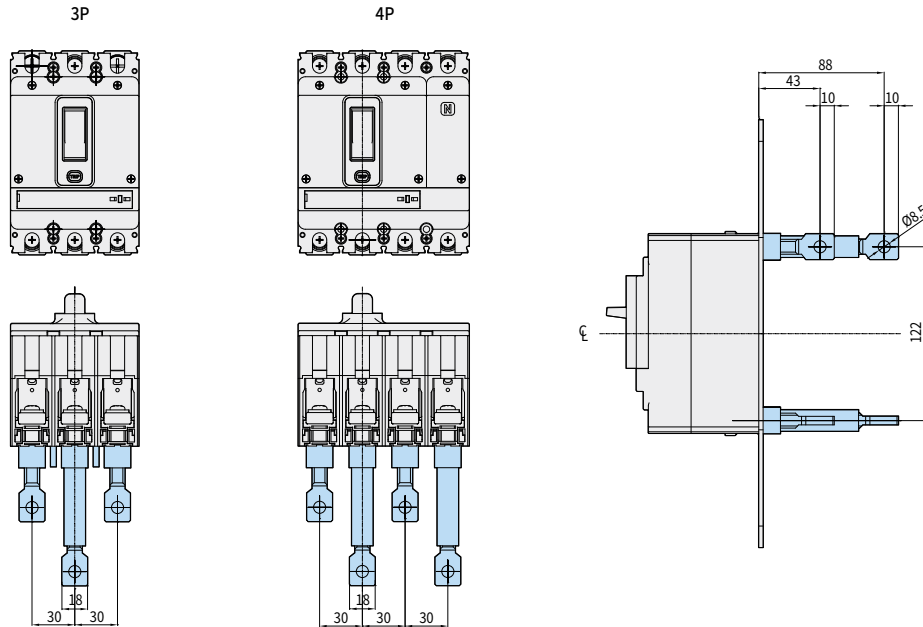

### Panel Installation Dimension

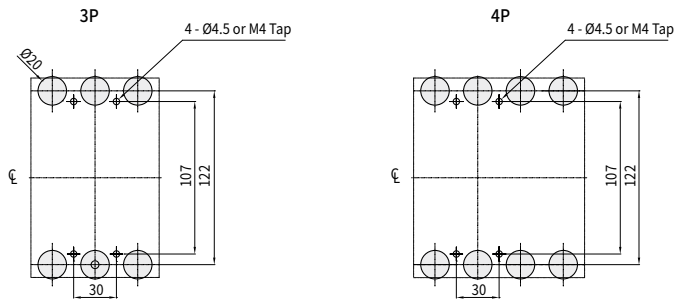

### Dimension of Panel Cover Cutting

Handle/Test Button Exposure

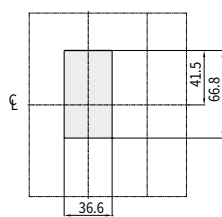

Handle/Trip Unit Exposure

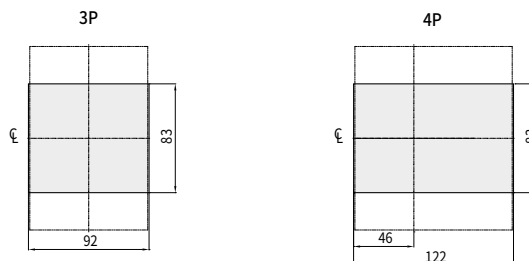

# Dimensions

## Rear Connection (Rear Type) HGP250

• HGP250

### External Dimension

Unit: mm

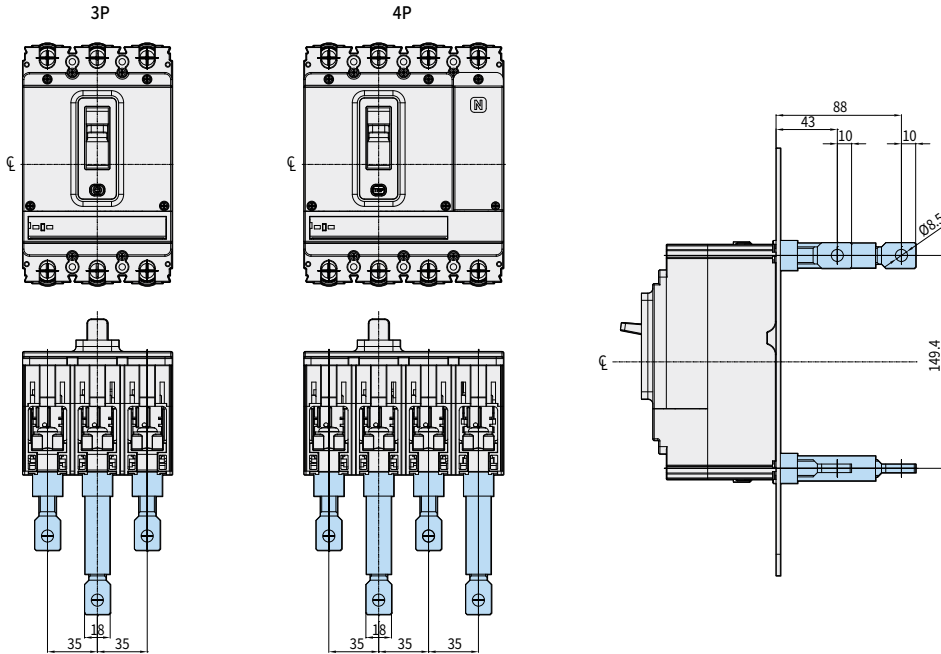

### Panel Installation Dimension

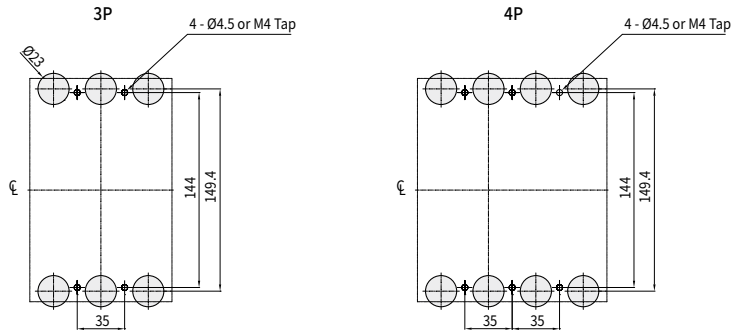

### Dimension of Panel Cover Cutting

Handle/Test Button Exposure

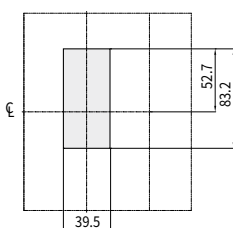

Handle/Trip Unit Exposure

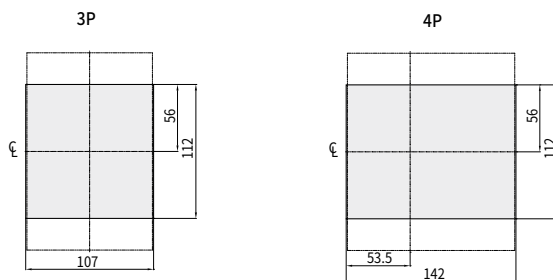

## Rear Connection (Rear Type) HGP630

• HGP400, 630

### External Dimension

Unit: mm

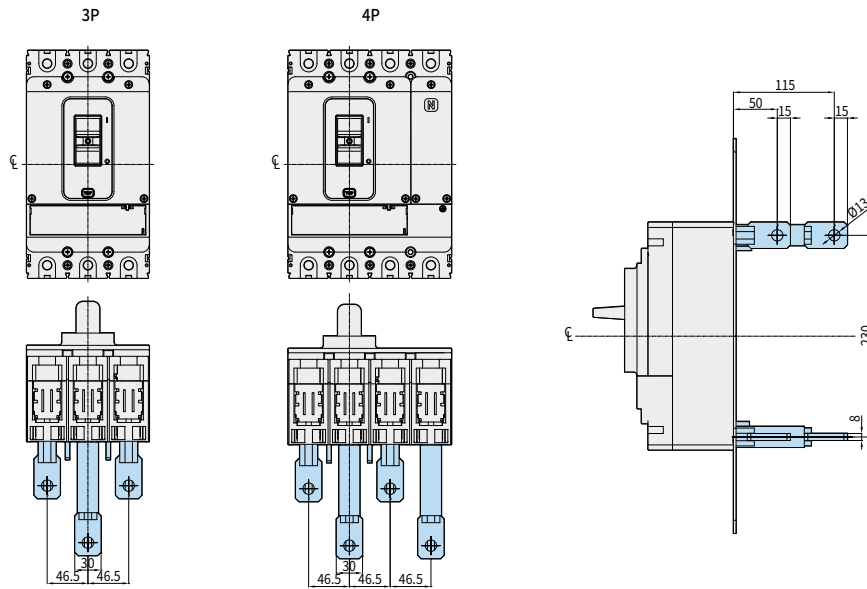

### Panel Installation Dimension

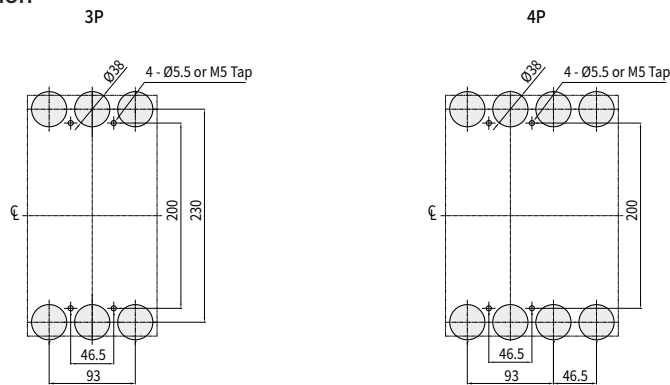

### Dimension of Panel Cover Cutting

Handle/Test Button Exposure

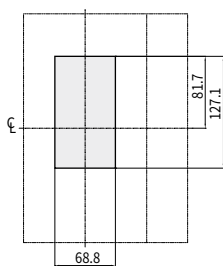

Handle/Trip Unit Exposure

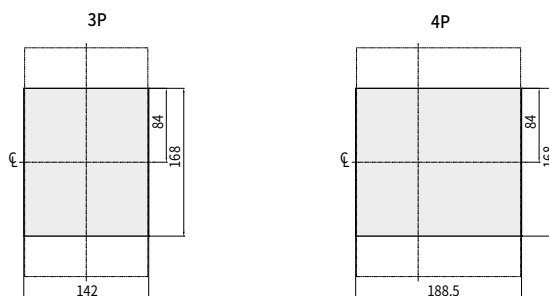

# Dimensions

## Rear Connection (Rear Type) HGP800

• HGP800

### External Dimension

Unit : mm

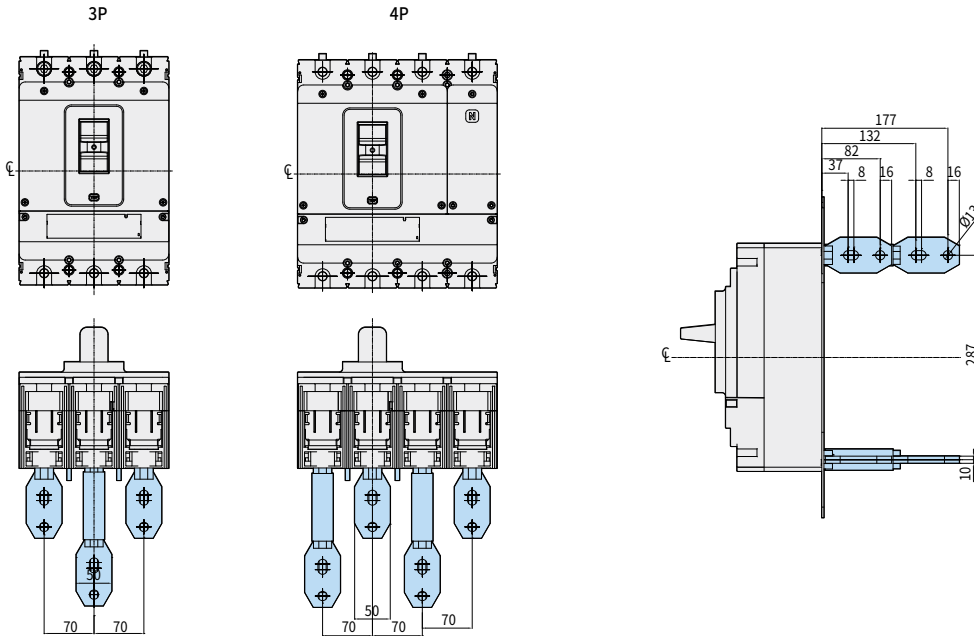

### Panel Installation Dimension

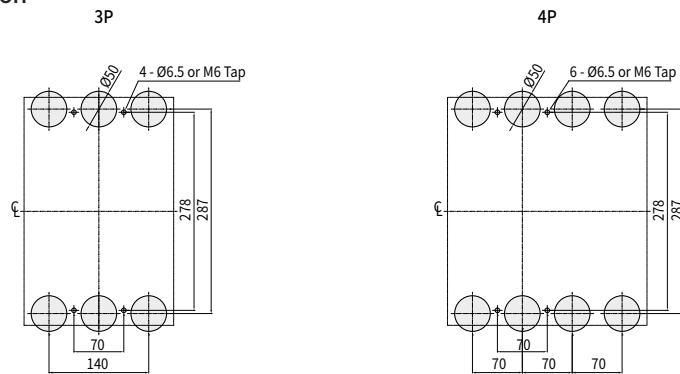

### Dimension of Panel Cover Cutting

Handle/Test Button Exposure

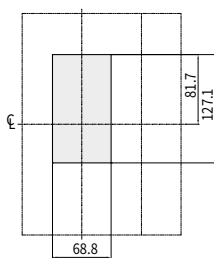

Handle/Trip Unit Exposure

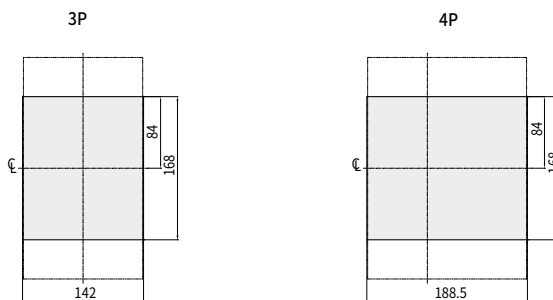

## Plug-in Type HGM100

• HGM30, 50E/S, 60, 100

### External Dimension (TDM Type)

Unit: mm

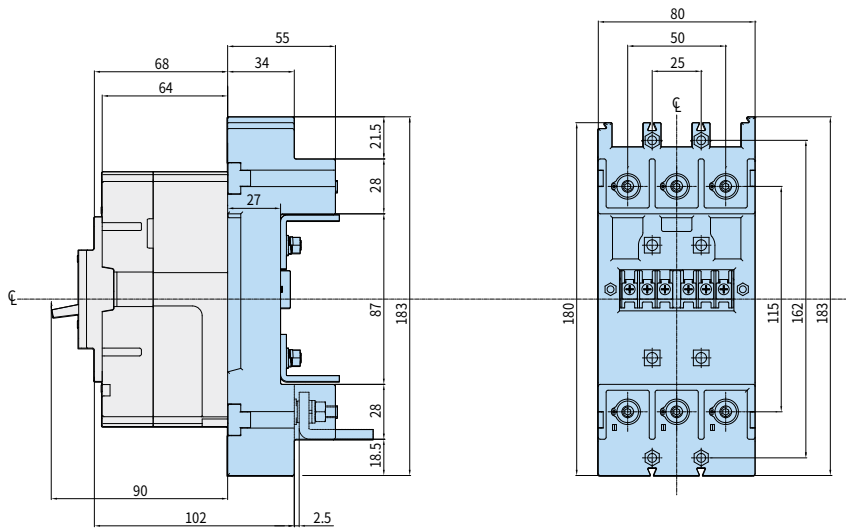

### Panel Installation Dimension and Cover Cutting Dimension

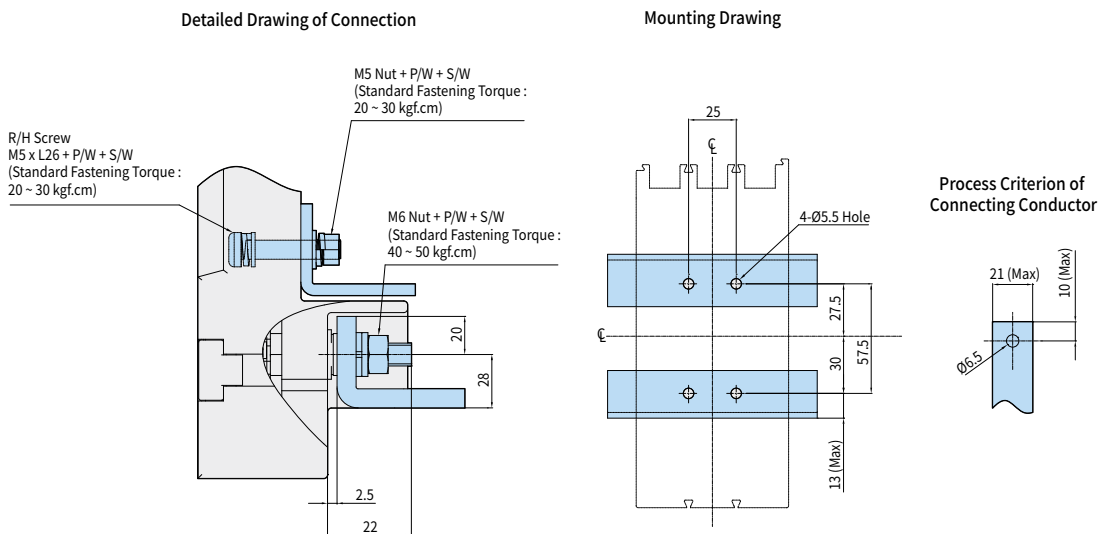

※ When installing the product in close contact, please consider tolerances for external dimensions.



## Plug-in Type HGM100

• HGM30, 50E/S, 60, 100

### External Dimension (TDA S Type)

Unit: mm

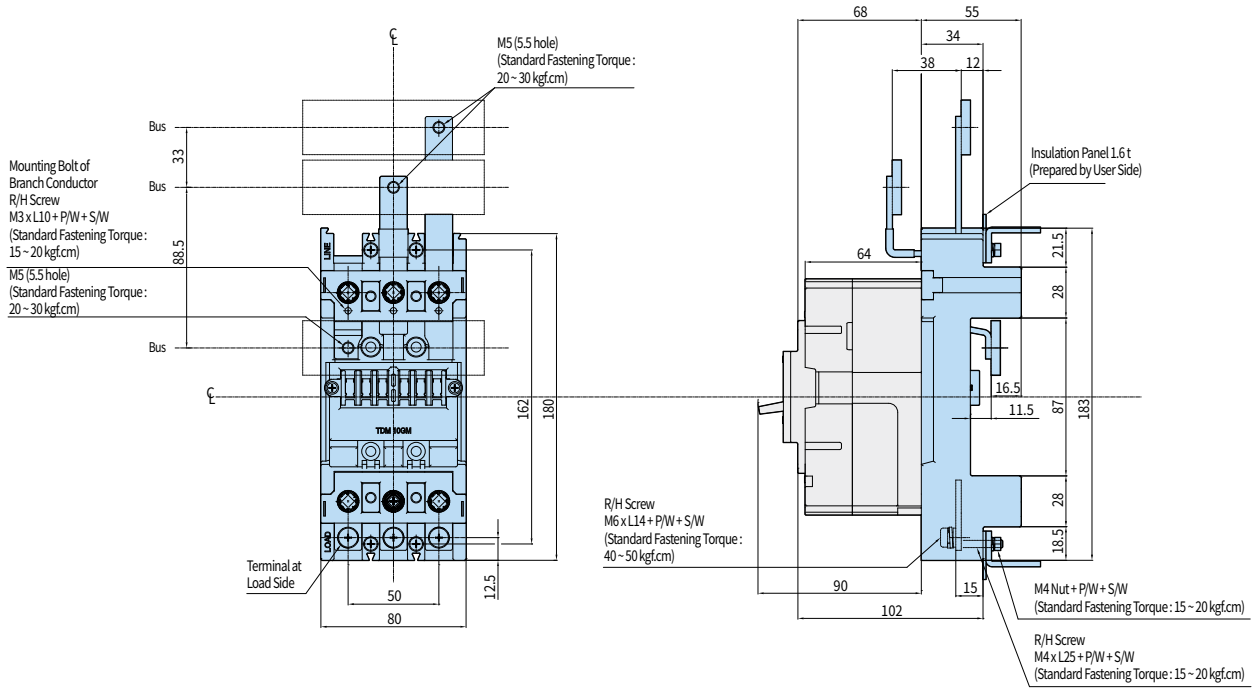

### Panel Installation Dimension and Cover Cutting Dimension

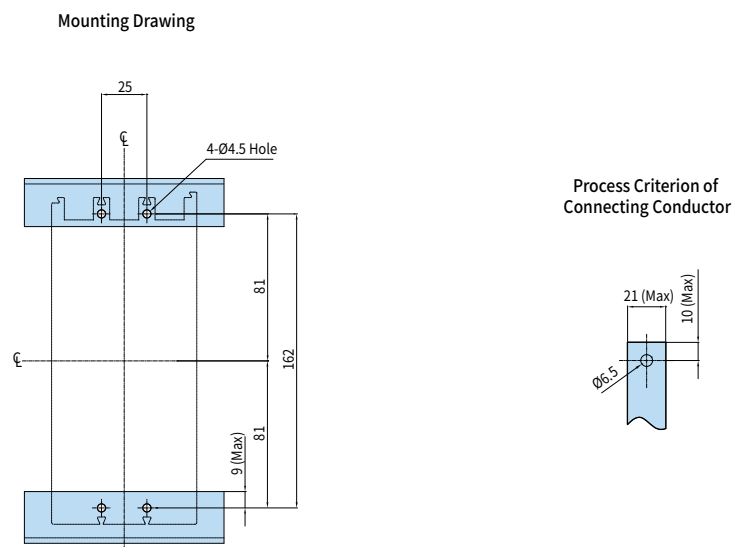

※ When installing the product in close contact, please consider tolerances for external dimensions.

# Dimensions

## Plug-in Type HGM100

• HGM30, 50E/S, 60, 100

External Dimension (TDF Type)

Unit : mm

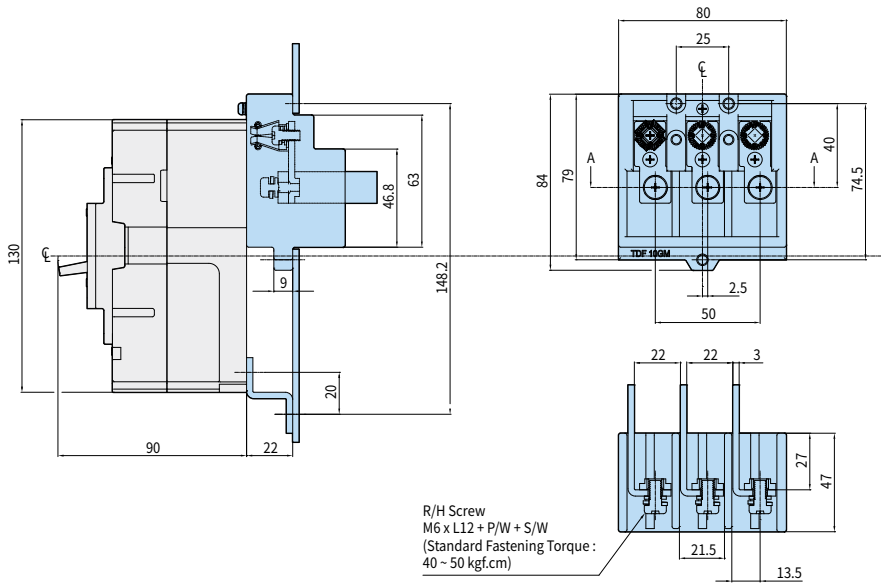

## Panel Installation Dimension and Cover Cutting Dimension

Mounting Drawing

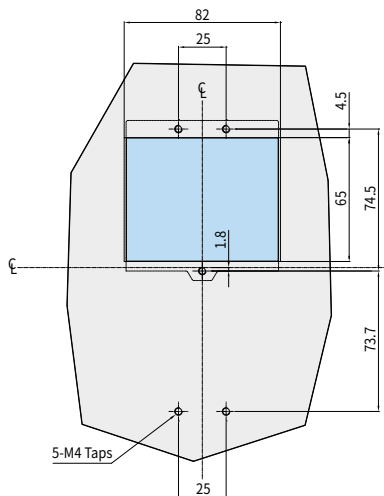

Process Criterion of Connecting Conductor

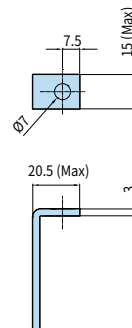

※ When installing the product in close contact, please consider tolerances for external dimensions.



## Plug-in Type HGM125

• HGM50H/L, 125

### External Dimension (TDM Type)

Unit: mm

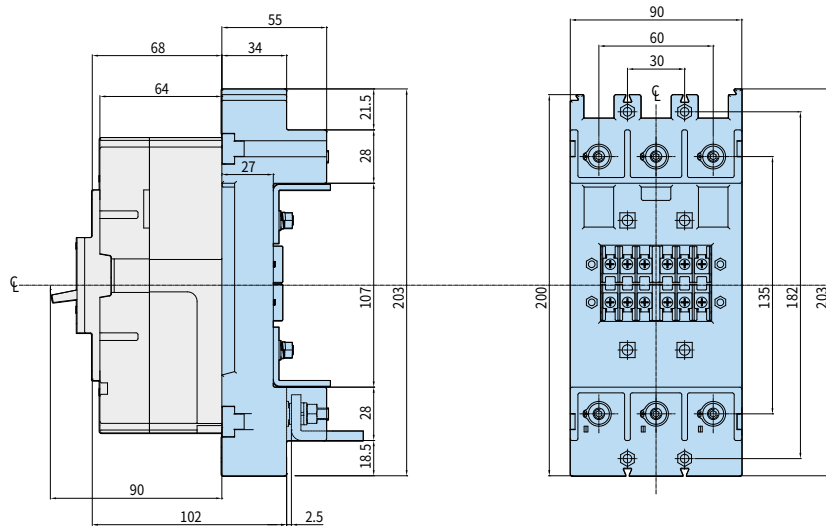

### Panel Installation Dimension and Cover Cutting Dimension

Detailed Drawing of Connection

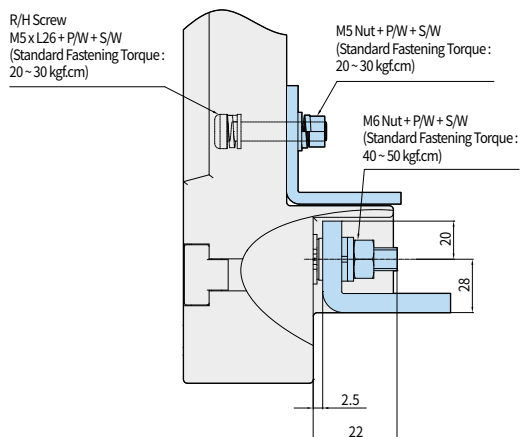

Mounting Drawing

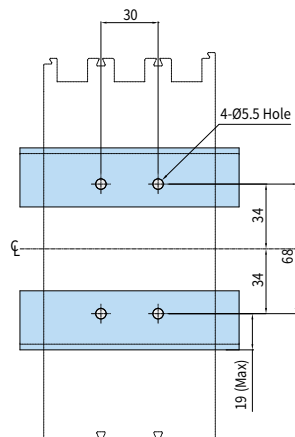

Process Criterion of Connecting Conductor

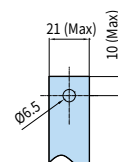

※ When installing the product in close contact, please consider tolerances for external dimensions.

# Dimensions

## Plug-in Type HGM125

• HGM50H/L, 125

### External Dimension (TDA D Type)

Unit : mm

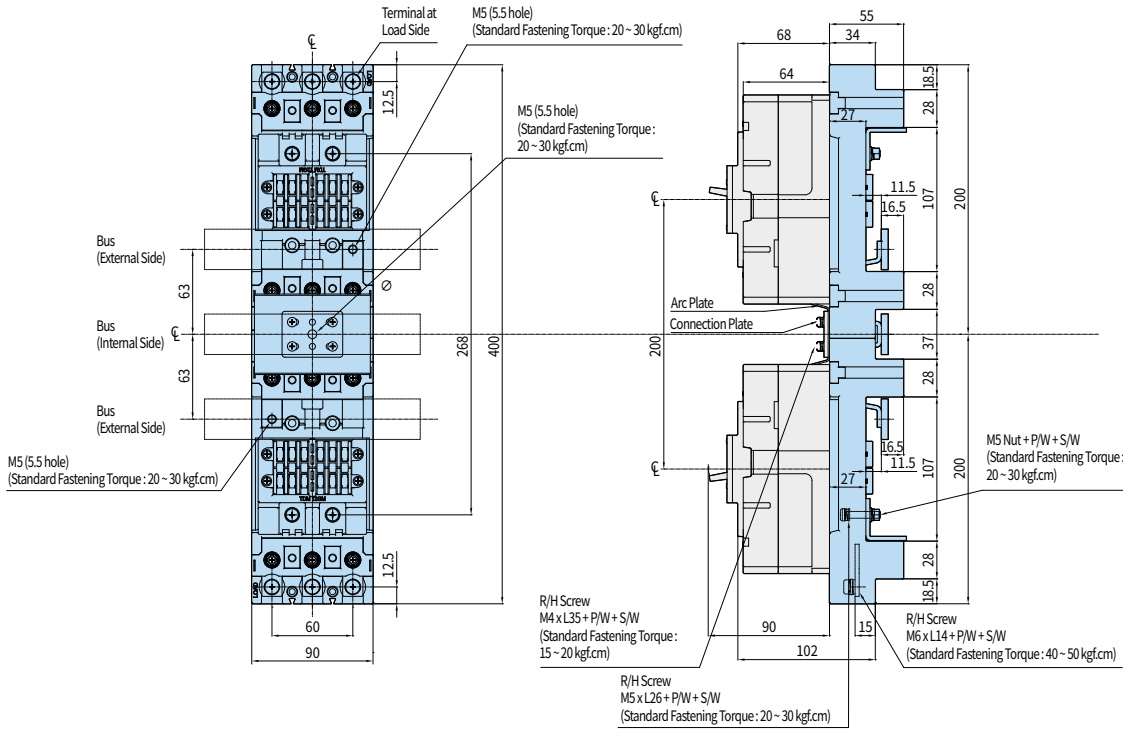

### Panel Installation Dimension and Cover Cutting Dimension

Mounting Drawing

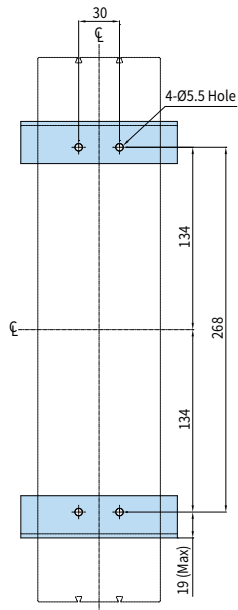

Process Criterion of Connecting Conductor

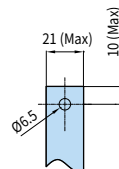

※ When installing the product in close contact, please consider tolerances for external dimensions.

## Plug-in Type HGM125

• HGM50H/L, 125

### External Dimension (TDA S Type)

Unit: mm

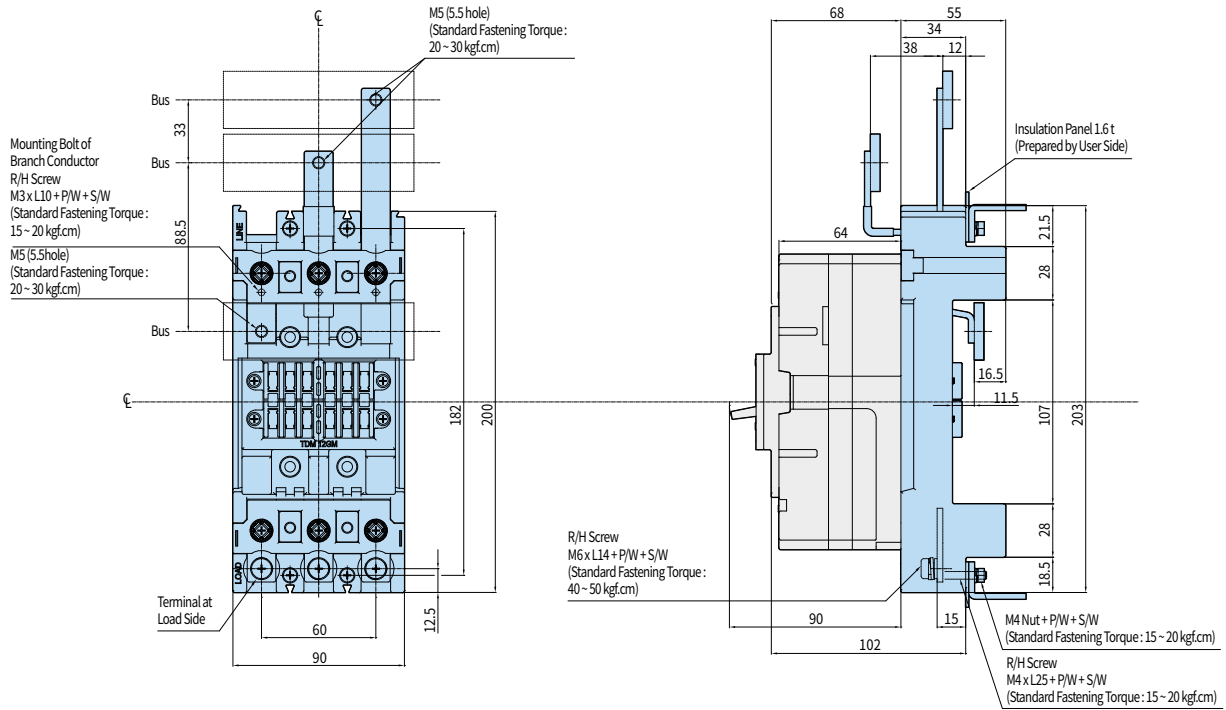

### Panel Installation Dimension and Cover Cutting Dimension

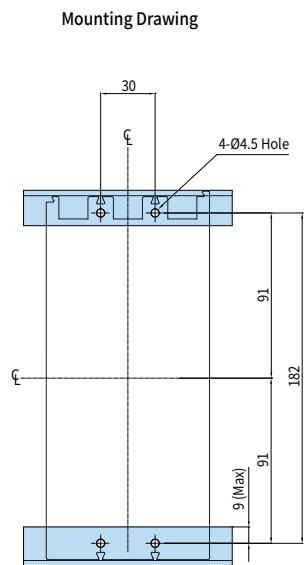

### Process Criterion of Connecting Conductor

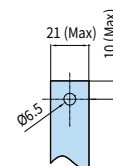

※ When installing the product in close contact, please consider tolerances for external dimensions.

# Dimensions

## Plug-in Type HGM125

• HGM50H/L, 125

External Dimension (TDF Type)

Unit : mm

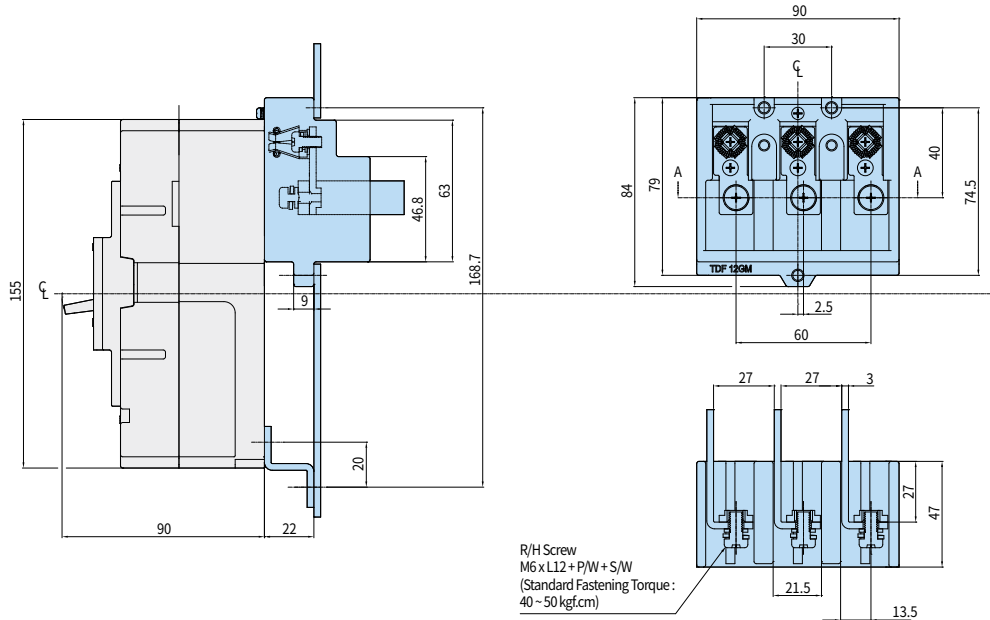

## Panel Installation Dimension and Cover Cutting Dimension

Mounting Drawing

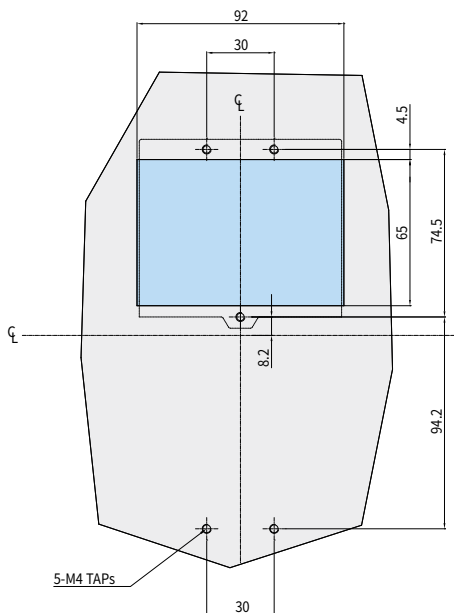

Process Criterion of Connecting Conductor

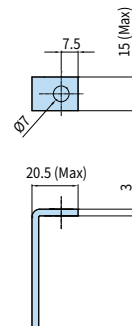

※ When installing the product in close contact, please consider tolerances for external dimensions.

Plug-in Type HGM250

• HGM160, 250

External Dimension (TDM Type)

Unit: mm

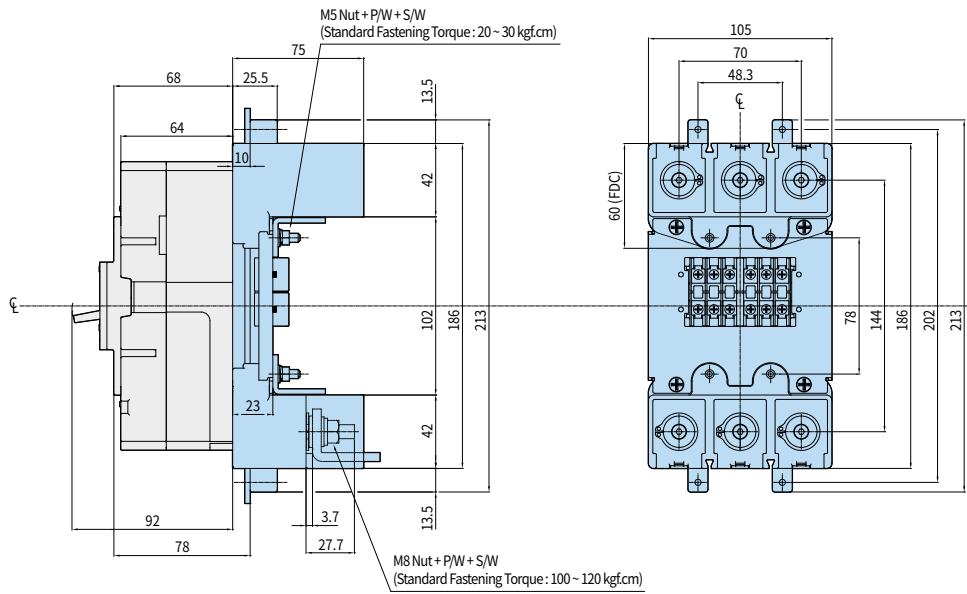

Panel Installation Dimension and Cover Cutting Dimension

Mounting Drawing

Dimension of Front Cover Cutting

Process Criterion of Connecting Conductor

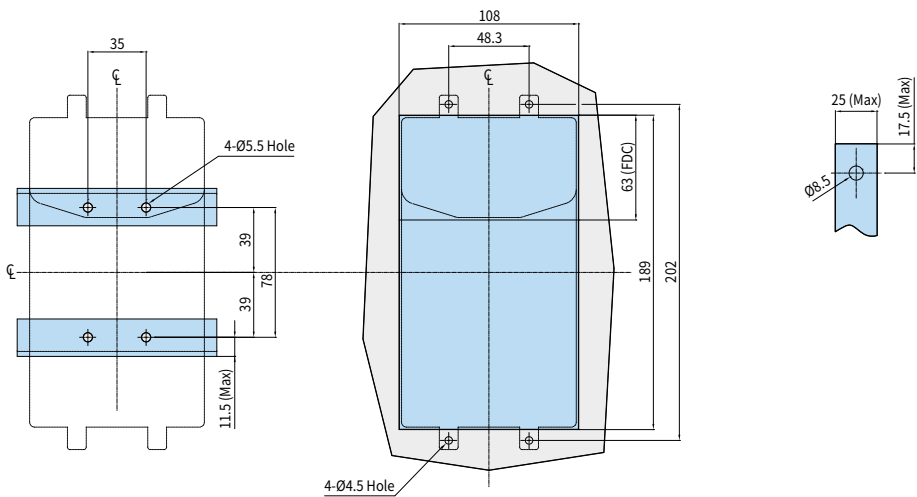

※ When installing the product in close contact, please consider tolerances for external dimensions.

# Dimensions

## Plug-in Type HGM400

• HGM400

### External Dimension (TDM Type)

Unit : mm

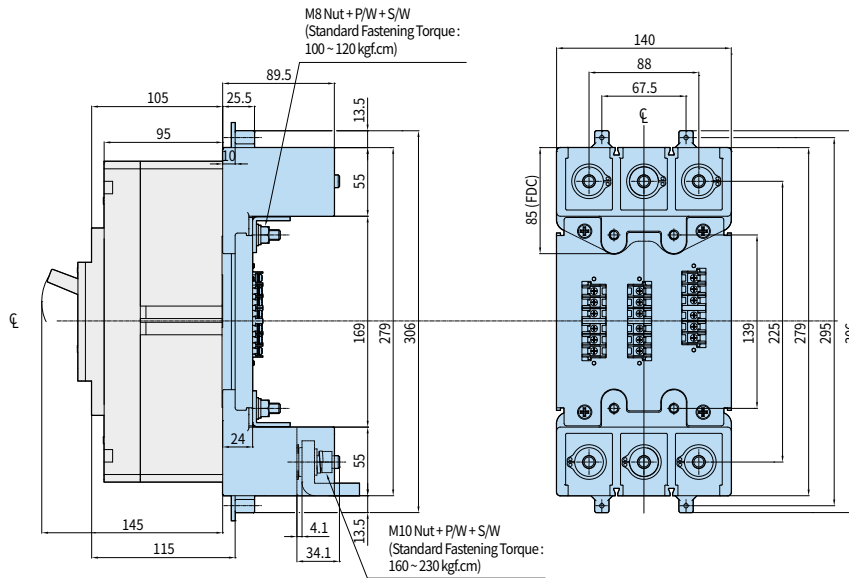

### Panel Installation Dimension and Cover Cutting Dimension

Mounting Drawing

Dimension of Front Cover Cutting

Process Criterion of Connecting Conductor

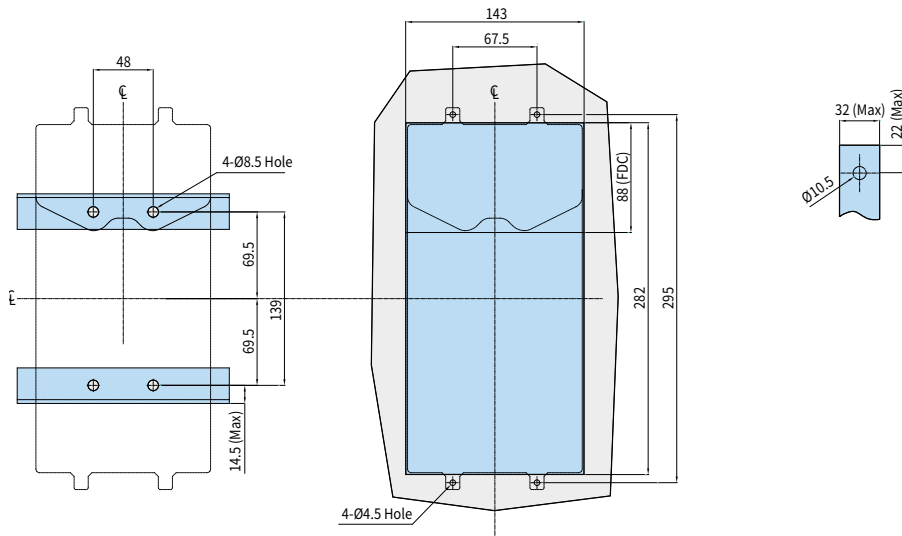

※ When installing the product in close contact, please consider tolerances for external dimensions.

Plug-in Type HGM800

• HGM630, 800

External Dimension (TDM Type)

Unit: mm

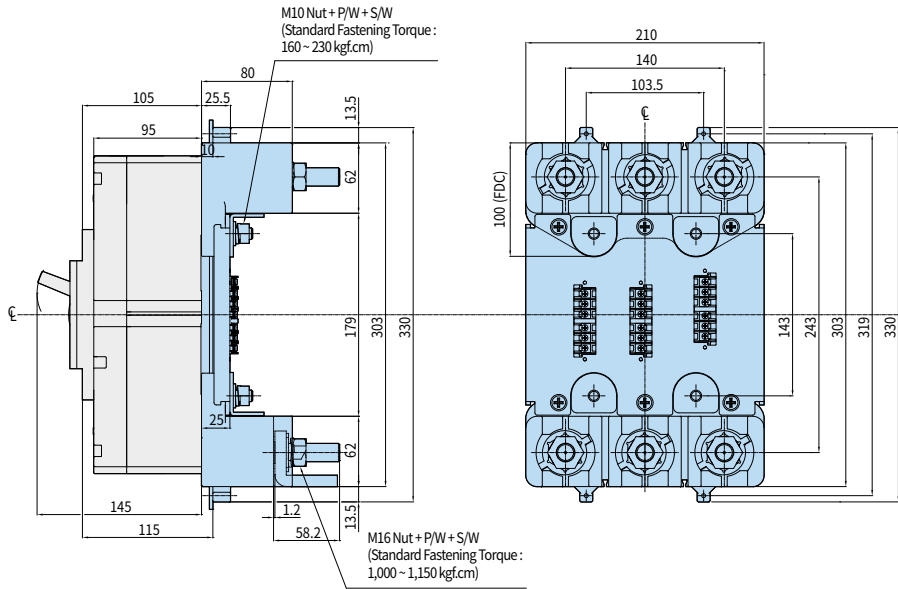

Panel Installation Dimension and Cover Cutting Dimension

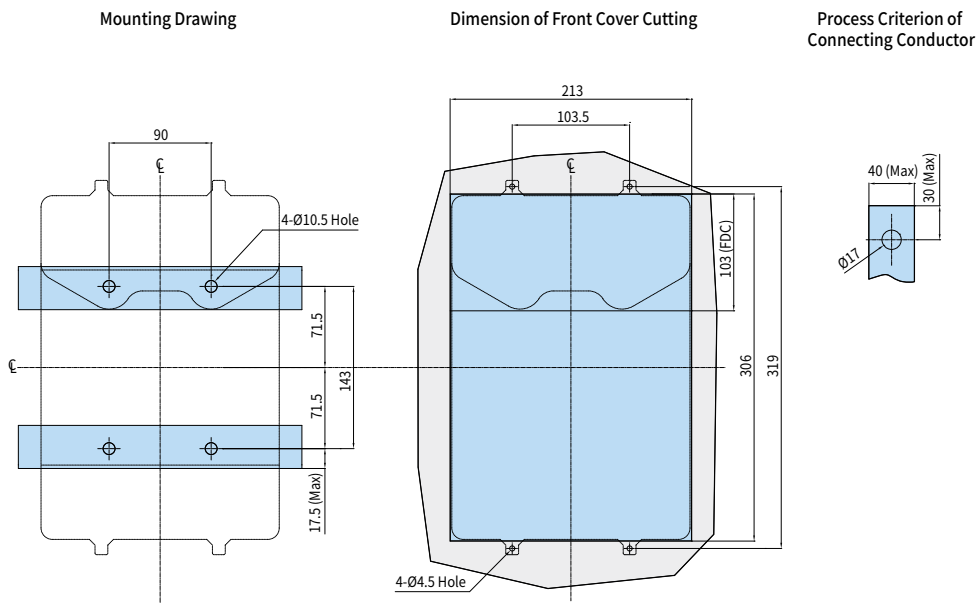

※ When installing the product in close contact, please consider tolerances for external dimensions.

# Dimensions

## Plug-in Type HGP160D

• HGP50D, 125D, 160D

### External Dimension

Unit : mm

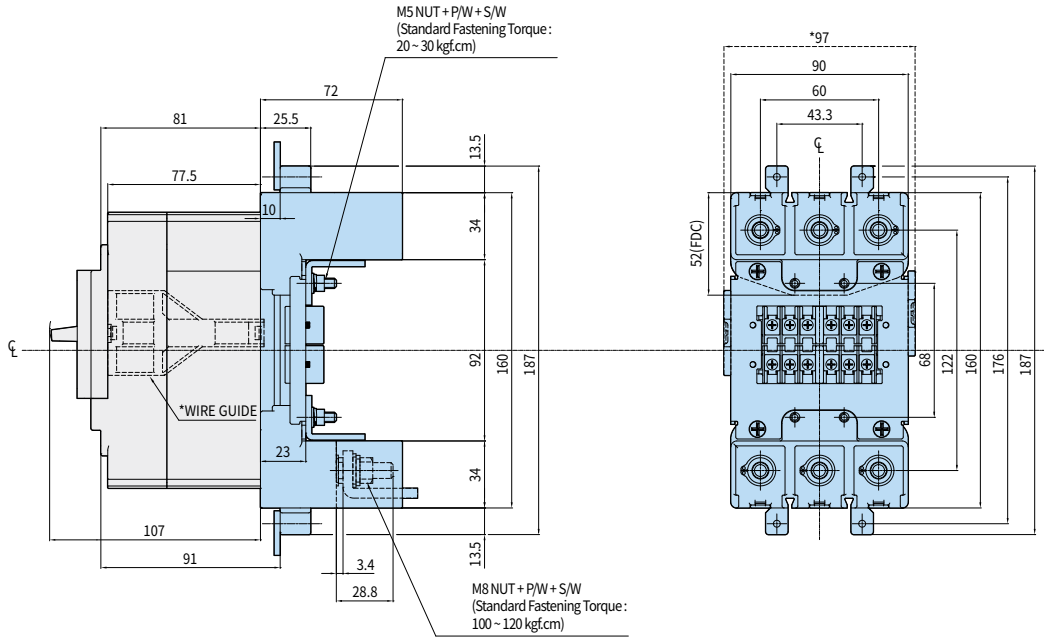

### Panel Installation Dimension and TDM Cover Cutting Dimension

Mounting Drawing

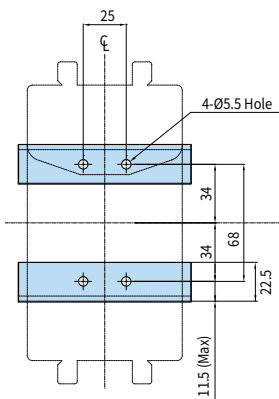

Dimension of Front Cover Cutting

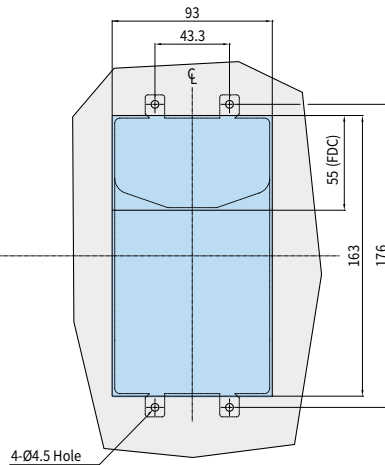

Process Criterion of Connecting Conductor

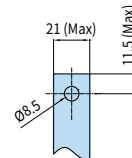

※ When installing the product in close contact, please consider tolerances for external dimensions.



## Plug-in Type HGP250

• HGP100, 160, 250

### External Dimension

Unit: mm

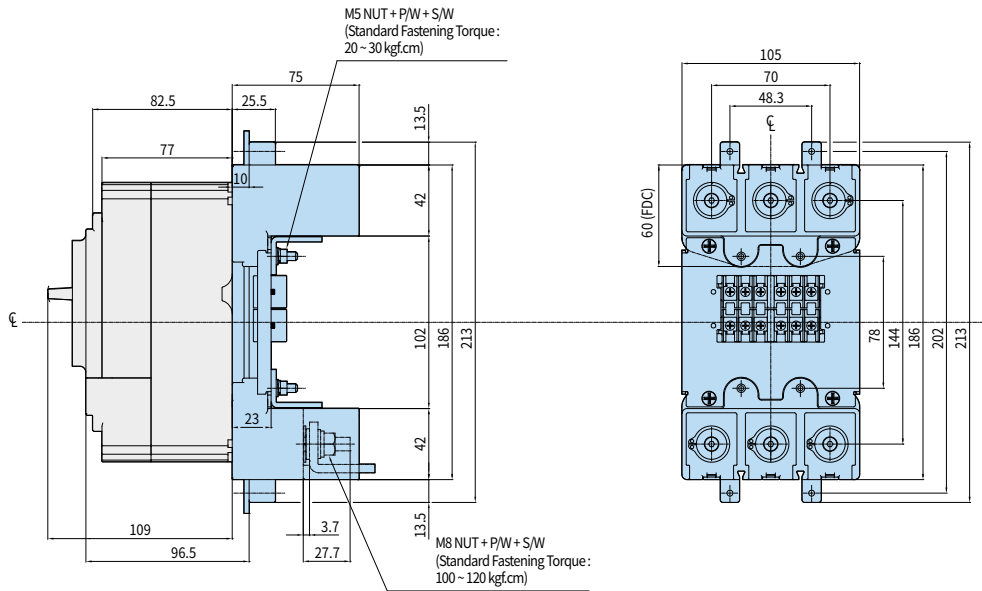

### Panel Installation Dimension and TDM Cover Cutting Dimension

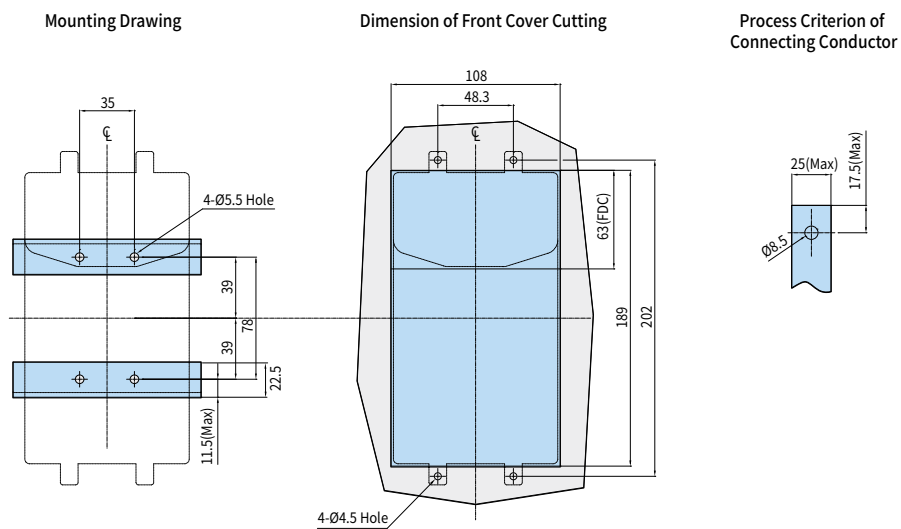

※ When installing the product in close contact, please consider tolerances for external dimensions.

# Dimensions

## Plug-in Type HGP630

• HGP400, 630

### External Dimension

Unit : mm

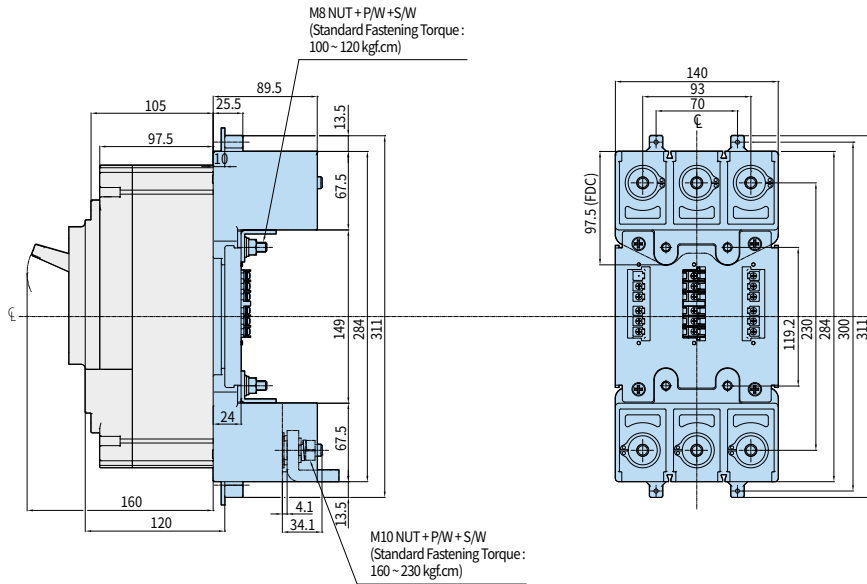

### Panel Installation Dimension and TDM Cover Cutting Dimension

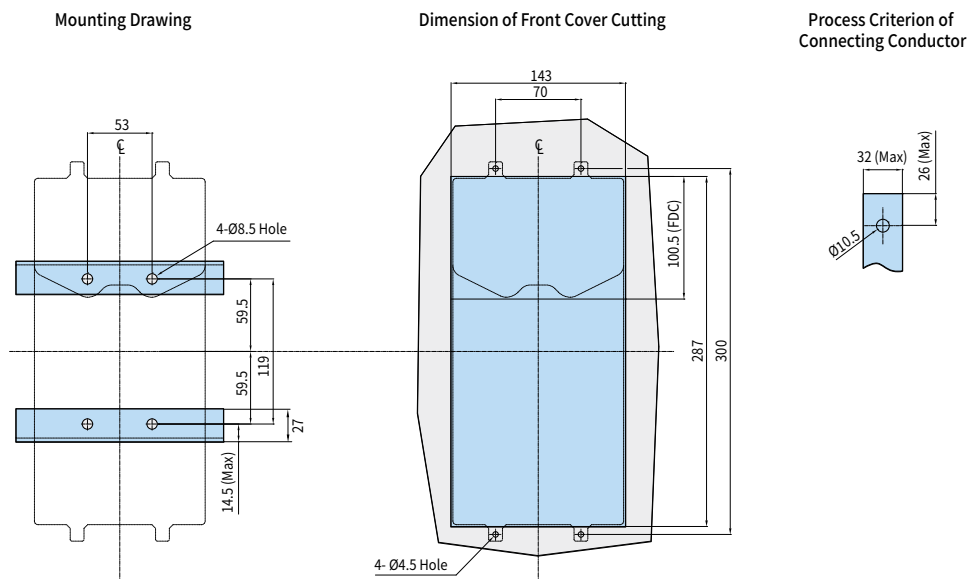

※ When installing the product in close contact, please consider tolerances for external dimensions.

## Plug-in Type HGP800

• HGP800

### External Dimension

Unit: mm

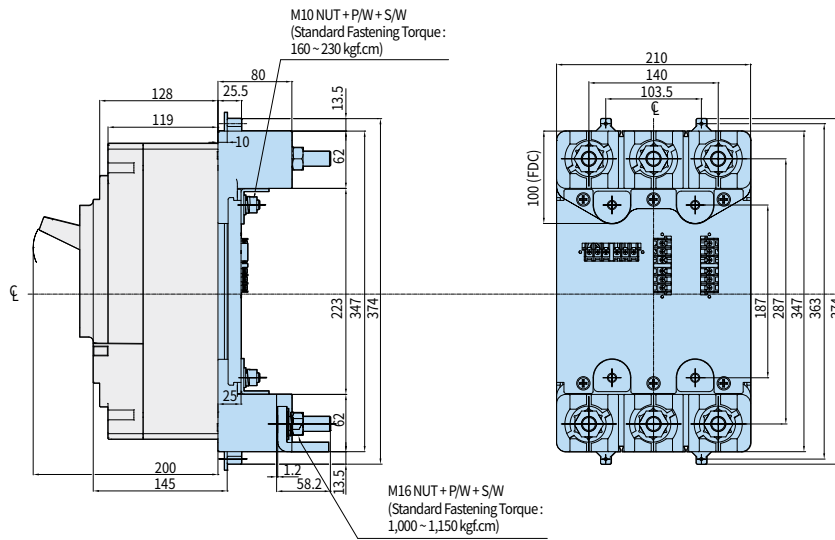

### Panel Installation Dimension and TDM Cover Cutting Dimension

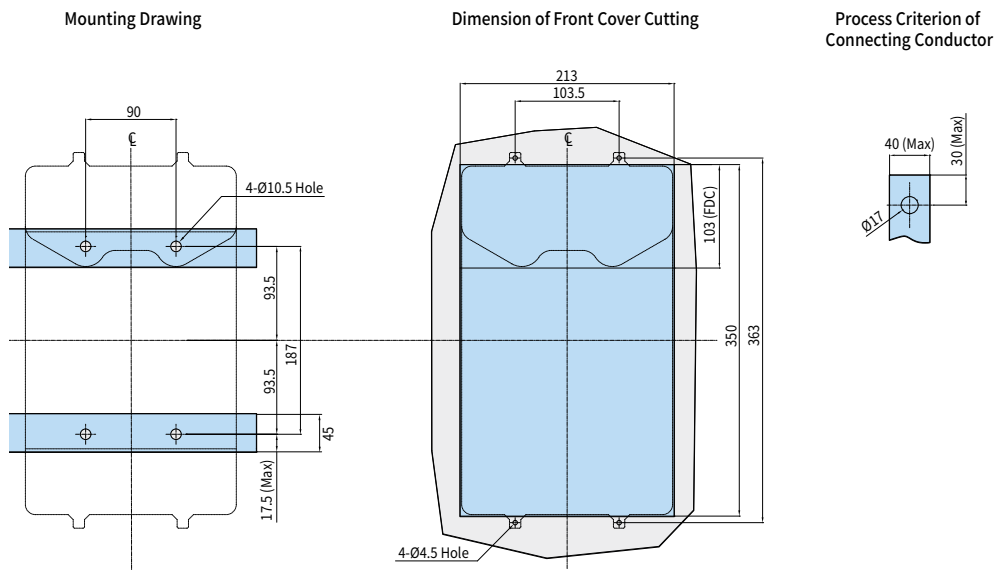

※ When installing the product in close contact, please consider tolerances for external dimensions.

## Dimensions

### External Rotary Handle HGM100

• HGM30, 50E/S, 60, 100

#### External Dimension - Front Contact Type

Unit : mm

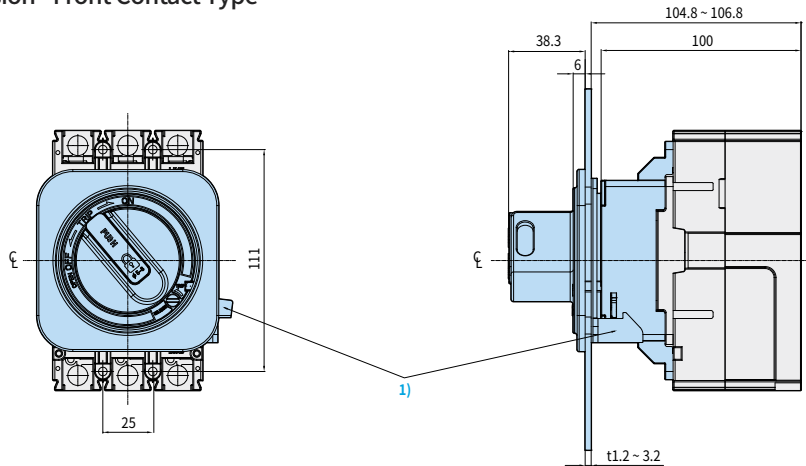

※ 1) Note that the LOCK PLATE may need to be positioned for combined operation with the handle.

#### External Dimension - Extension Type

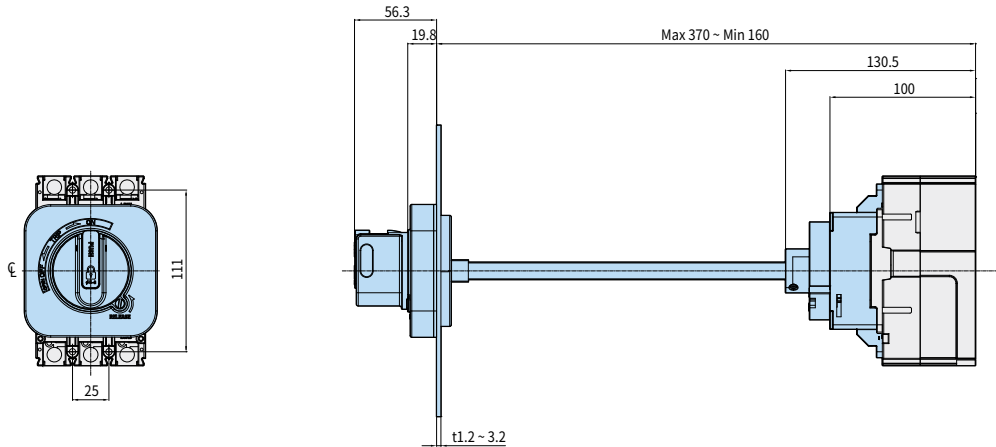

#### Panel Installation Dimension

Front Contact Type

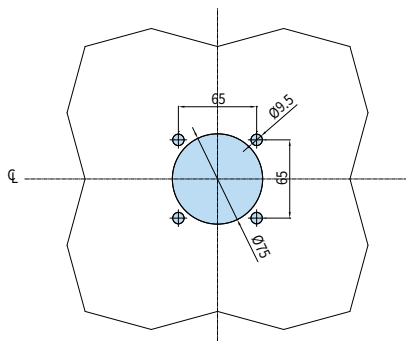

Extension Type

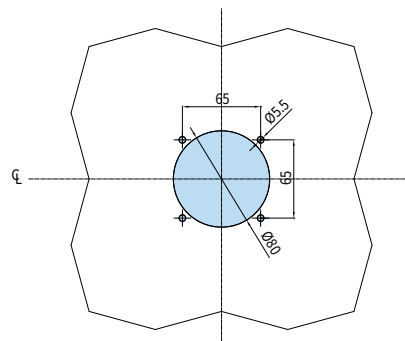

※ When installing the product in close contact, please consider tolerances for external dimensions.

## External Rotary Handle HGM125

• HGM50H/L, 125

### External Dimension - Front Contact Type

Unit: mm

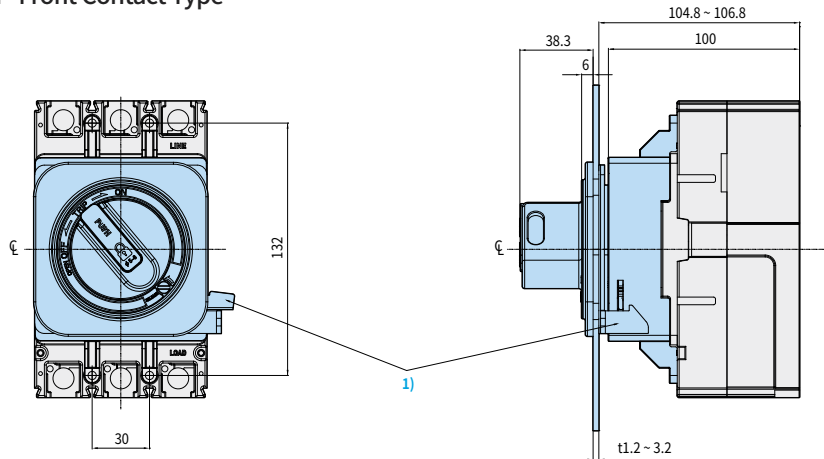

※ 1) Note that the LOCK PLATE may need to be positioned for combined operation with the handle.

### External Dimension - Extension Type

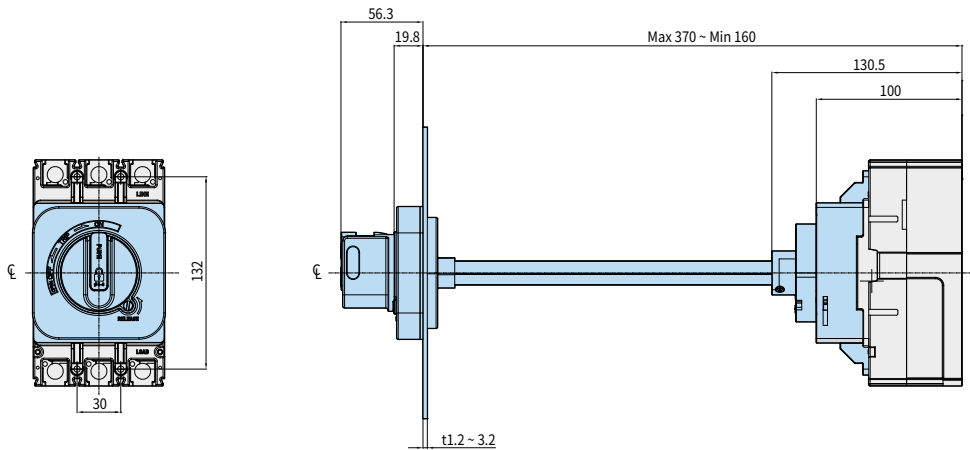

### Panel Installation Dimension

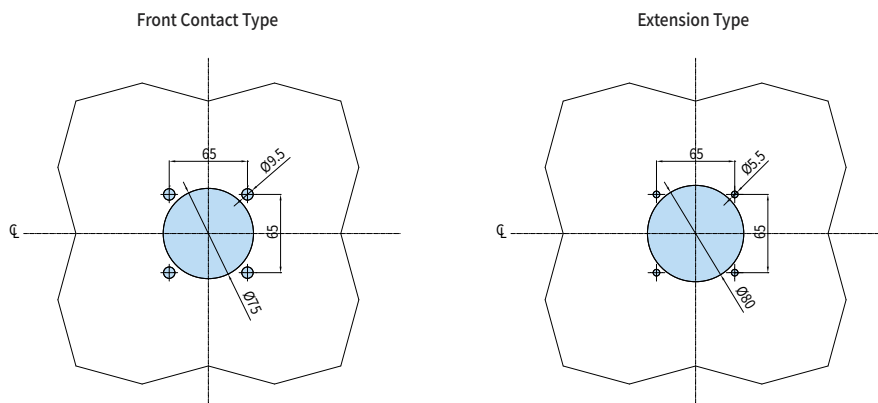

※ When installing the product in close contact, please consider tolerances for external dimensions.

# Dimensions

## External Rotary Handle HGM250

• HGM160, 250

### External Dimension - Front Contact Type

Unit : mm

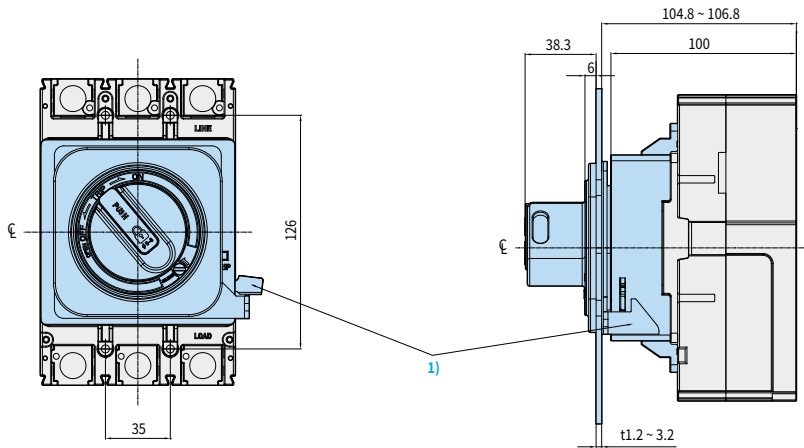

※ 1) Note that the LOCK PLATE may need to be positioned for combined operation with the handle.

### External Dimension - Extension Type

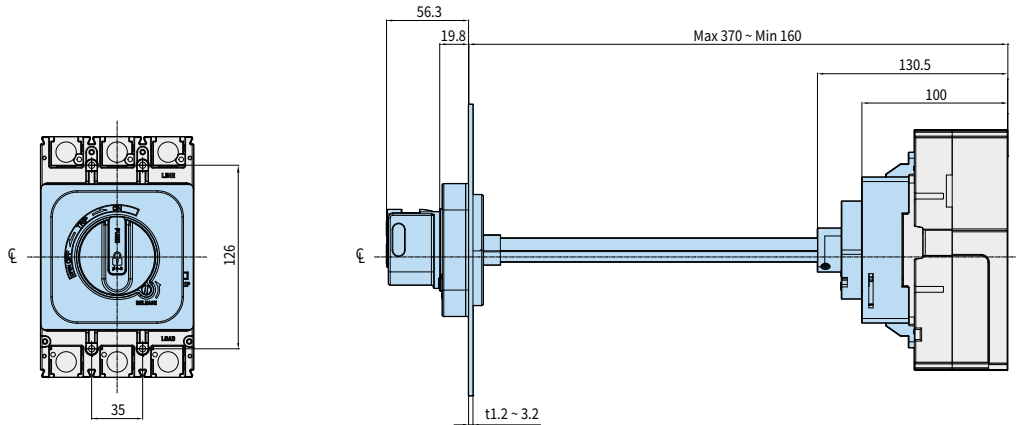

### Panel Installation Dimension

Front Contact Type

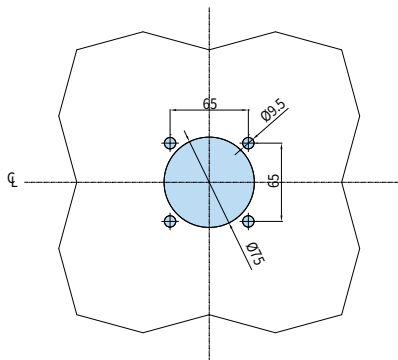

Extension Type

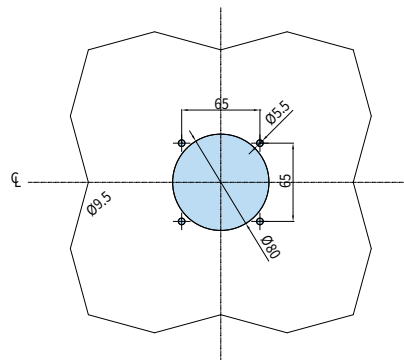

※ When installing the product in close contact, please consider tolerances for external dimensions.

## External Rotary Handle HGM400

• HGM400

### External Dimension - Front Contact Type

Unit: mm

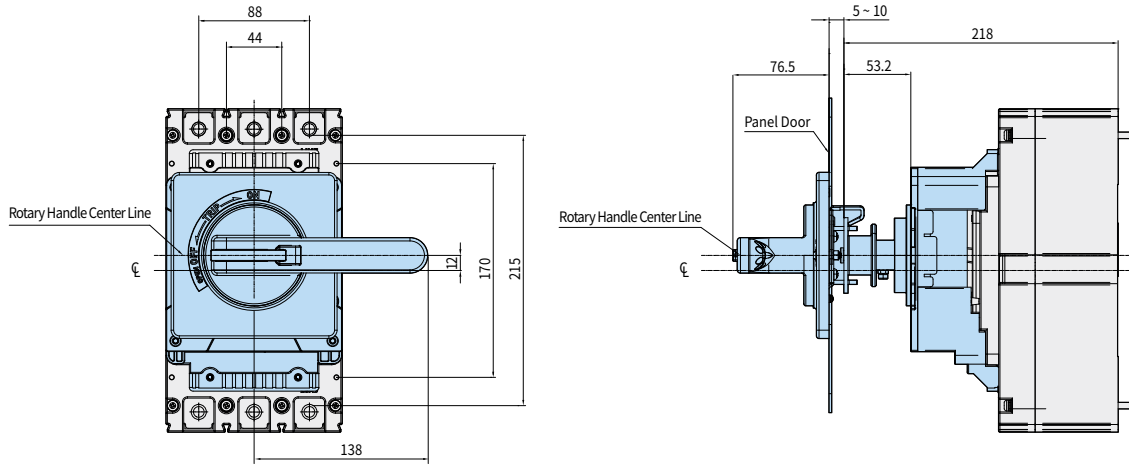

### External Dimension - Extension Type

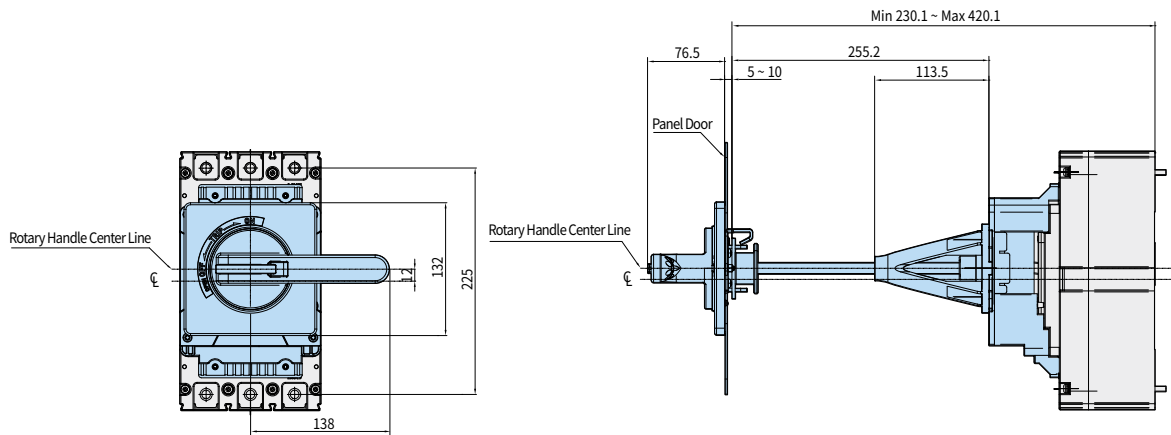

### Panel Installation Dimension

Front Contact Type

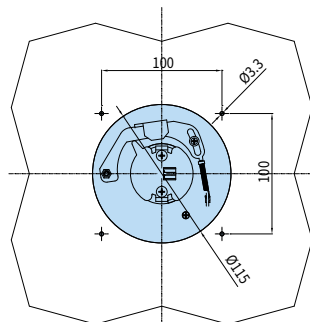

Extension Type

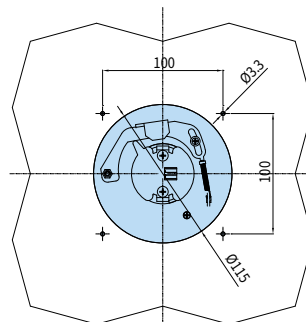

※ When installing the product in close contact, please consider tolerances for external dimensions.

# Dimensions

## External Rotary Handle HGM800

• HGM630, 800

### External Dimension - Front Contact Type

Unit : mm

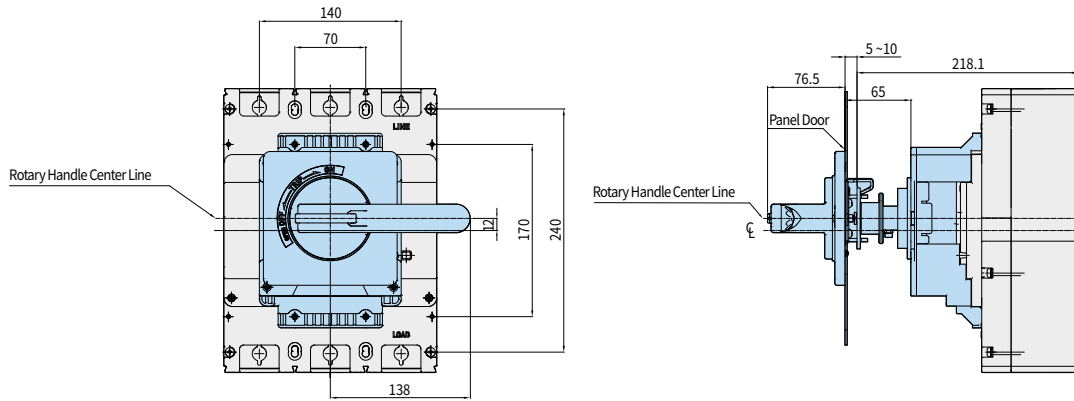

### External Dimension - Extension Type

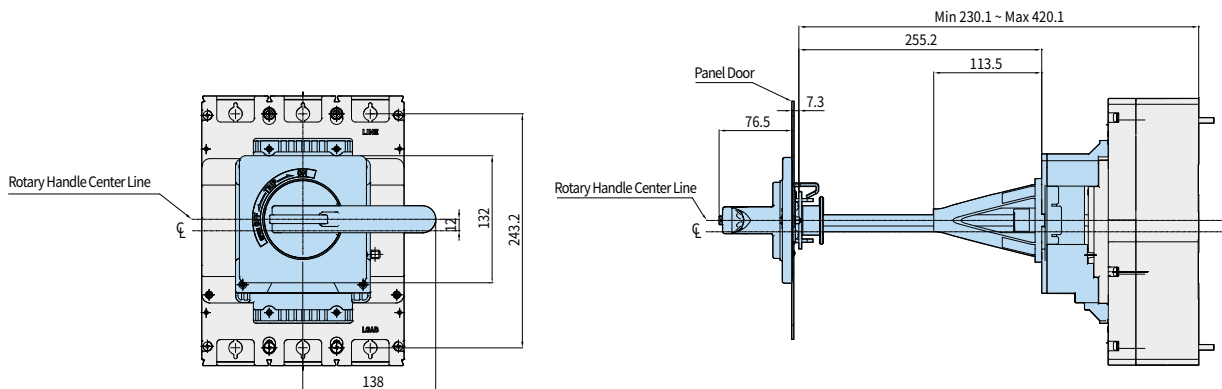

### Panel Installation Dimension

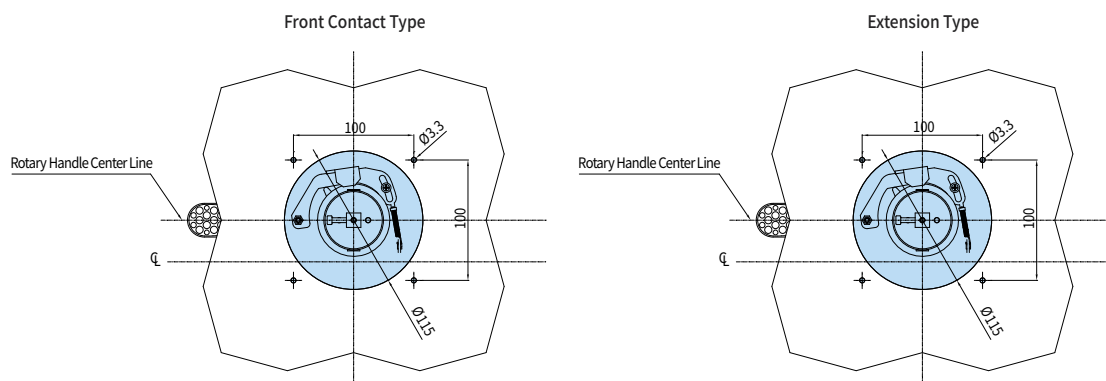

※ When installing the product in close contact, please consider tolerances for external dimensions.



## External Rotary Handle HGP160D

• HGP50D, 125D, 160D

### External Dimension - Front Contact Type

Unit: mm

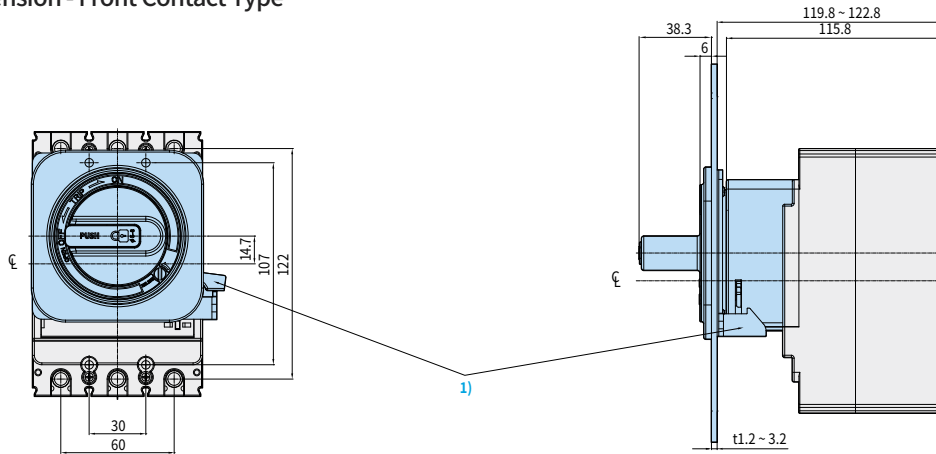

※ 1) Note that the LOCK PLATE may need to be positioned for combined operation with the handle.

### External Dimension - Extension Type

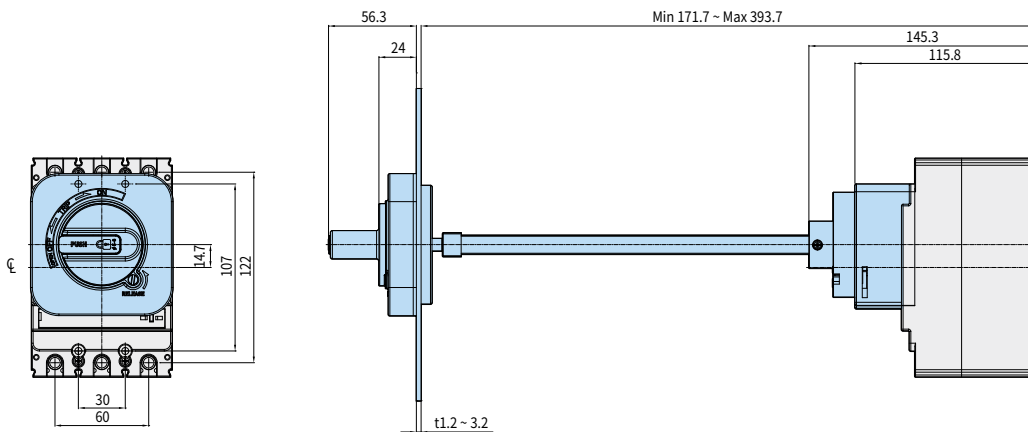

### Panel Installation Dimension

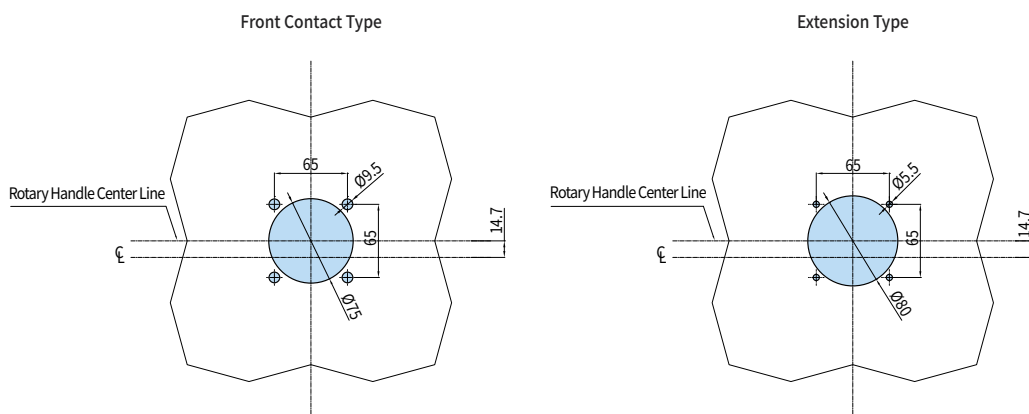

※ When installing the product in close contact, please consider tolerances for external dimensions.

# Dimensions

## External Rotary Handle HGP250

• HGP100, 160, 250

### External Dimension - Front Contact Type

Unit : mm

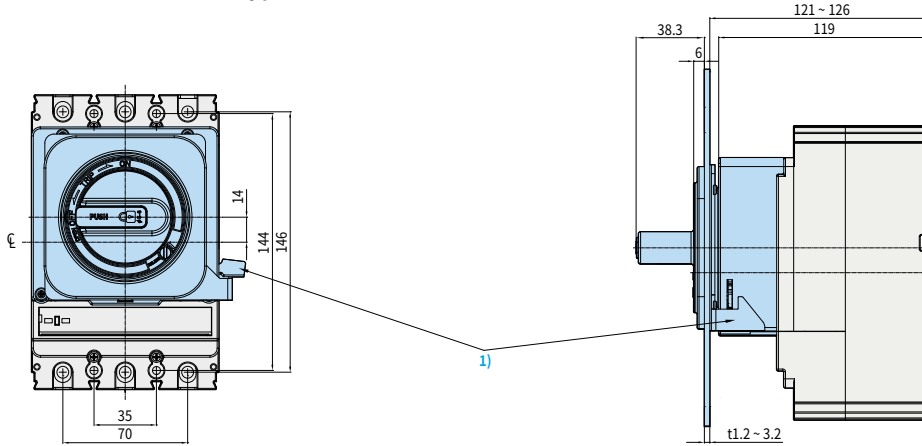

※ 1) Note that the LOCK PLATE may need to be positioned for combined operation with the handle.

### External Dimension - Extension Type

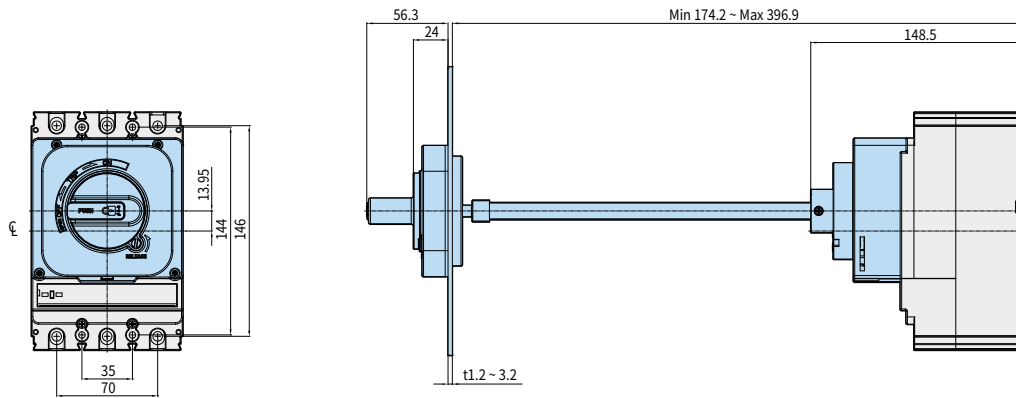

### Panel Installation Dimension

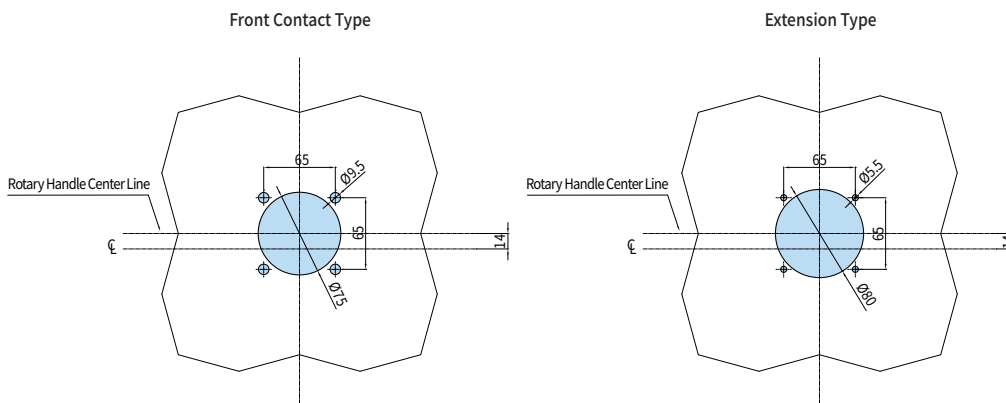

※ When installing the product in close contact, please consider tolerances for external dimensions.

## External Rotary Handle HGP630

• HGP400, 630

### External Dimension - Front Contact Type

Unit: mm

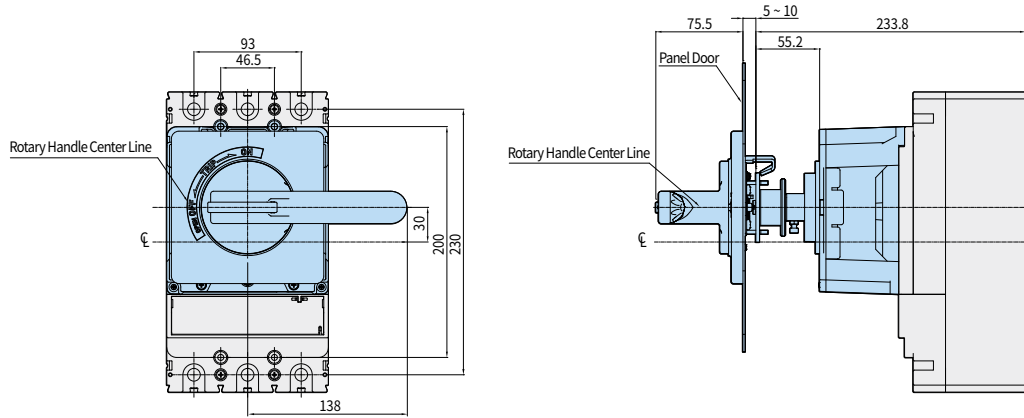

### External Dimension - Extension Type

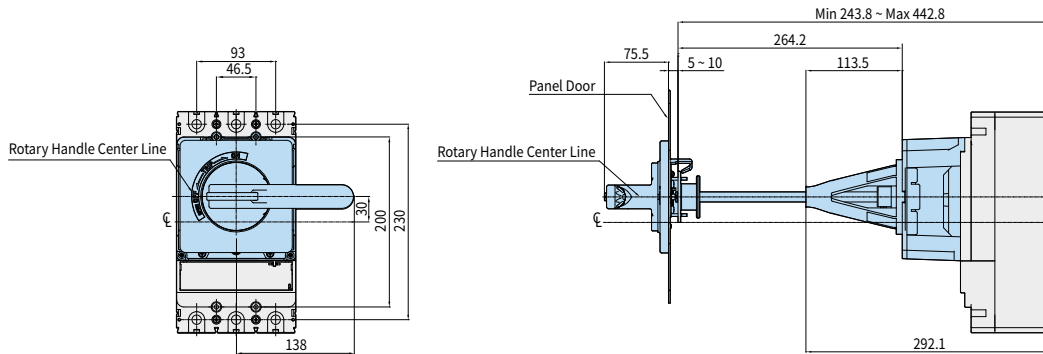

### Panel Installation Dimension

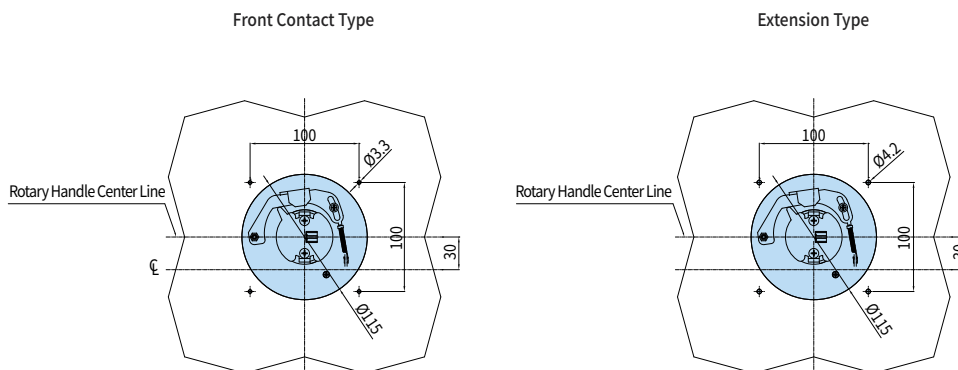

※ When installing the product in close contact, please consider tolerances for external dimensions.

# Dimensions

## External Rotary Handle HGP800

• HGP800

### External Dimension - Front Contact Type

Unit : mm

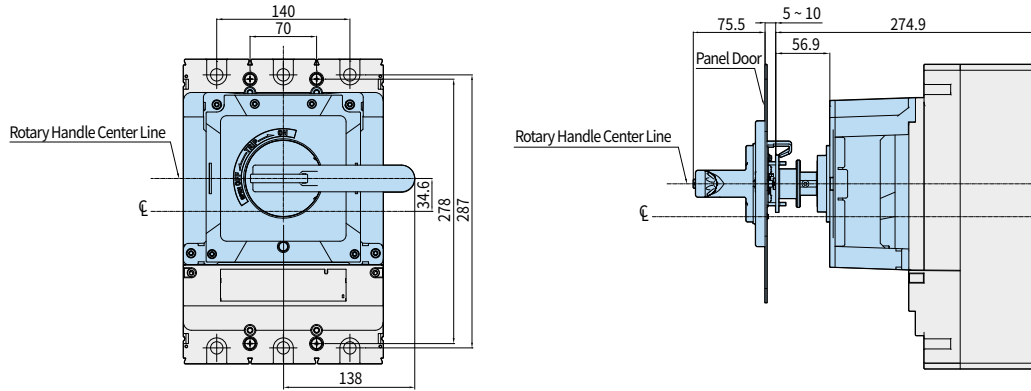

### External Dimension - Extension Type

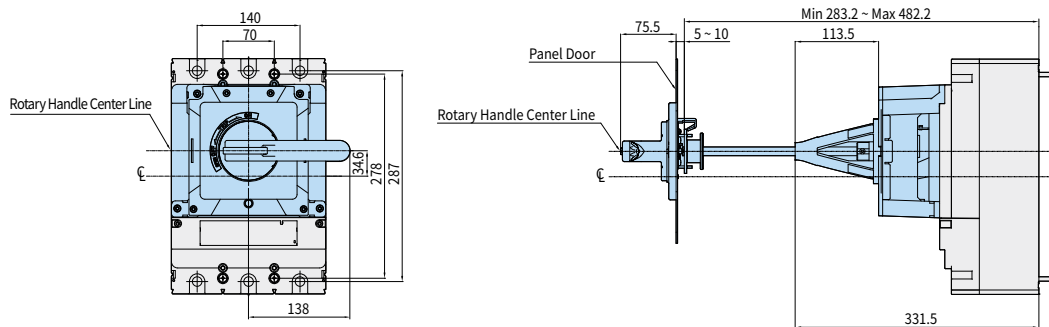

### Panel Installation Dimension

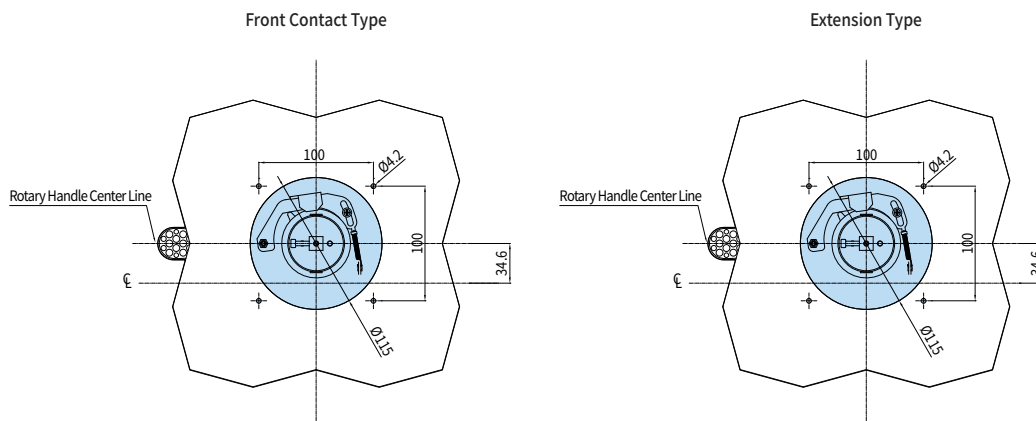

※ When installing the product in close contact, please consider tolerances for external dimensions.

## Mechanical Interlock HGM100

• HGM30, 50E/S, 60, 100

### External Dimension

Unit: mm

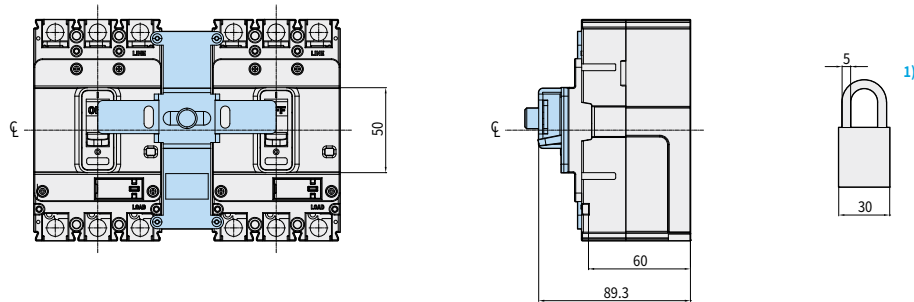

### Panel Installation Dimension

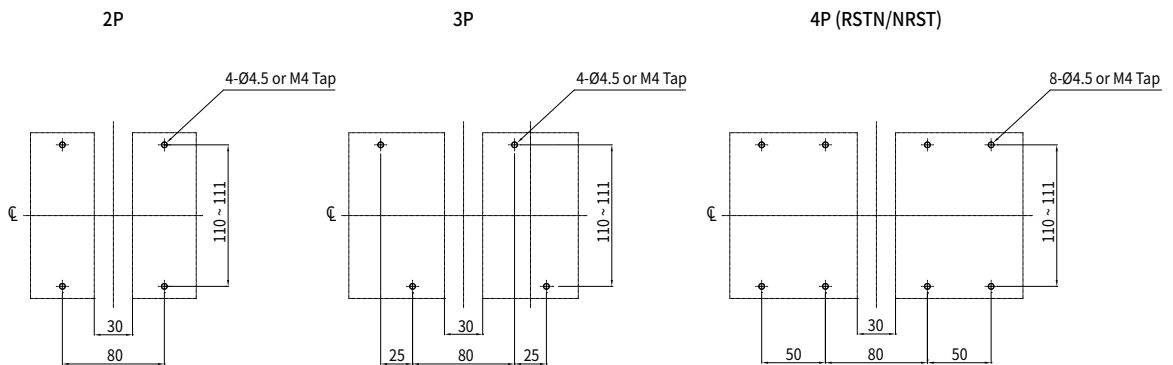

### Dimension of Panel Cover Cutting

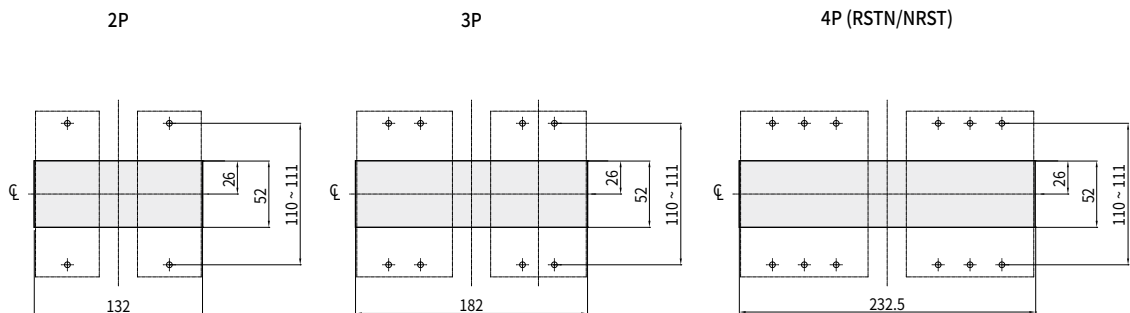

※ 1) Padlock not included.

※ When installing the product in close contact, please consider tolerances for external dimensions.

# Dimensions

## Mechanical Interlock HGM125

• HGM50H/L, 125

### External Dimension

Unit: mm

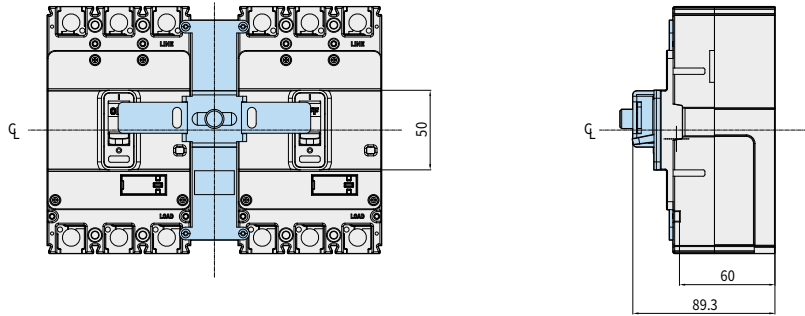

### Panel Installation Dimension

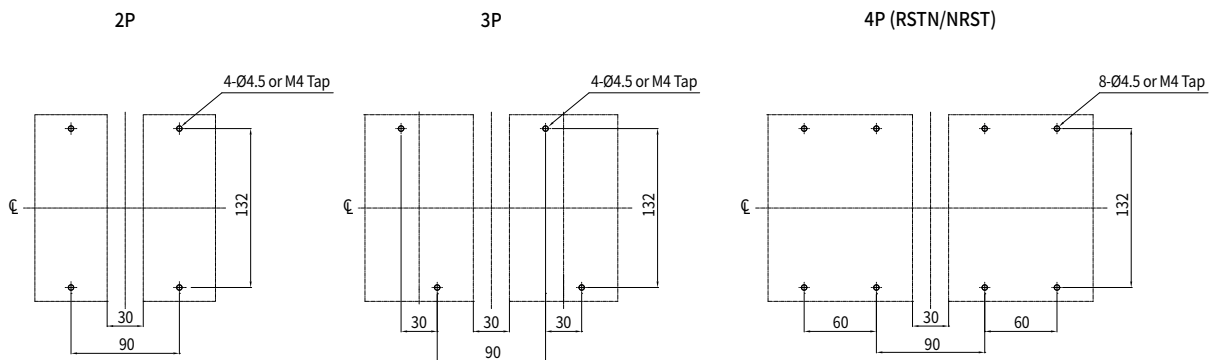

### Dimension of Panel Cover Cutting

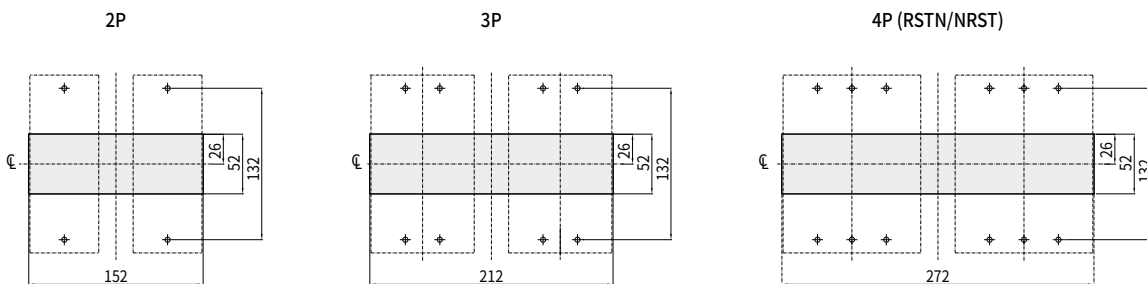

※ When installing the product in close contact, please consider tolerances for external dimensions.

## Mechanical Interlock HGM250

• HGM160, 250

### External Dimension

Unit: mm

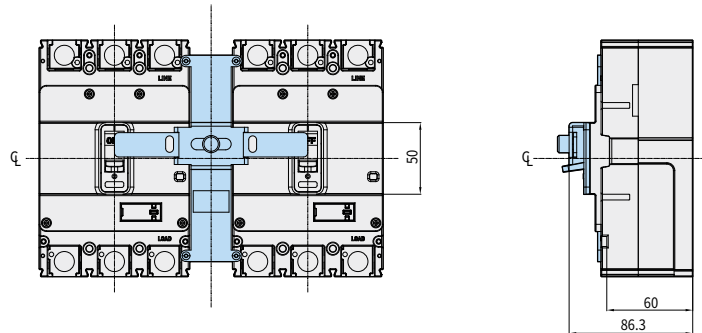

### Panel Installation Dimension

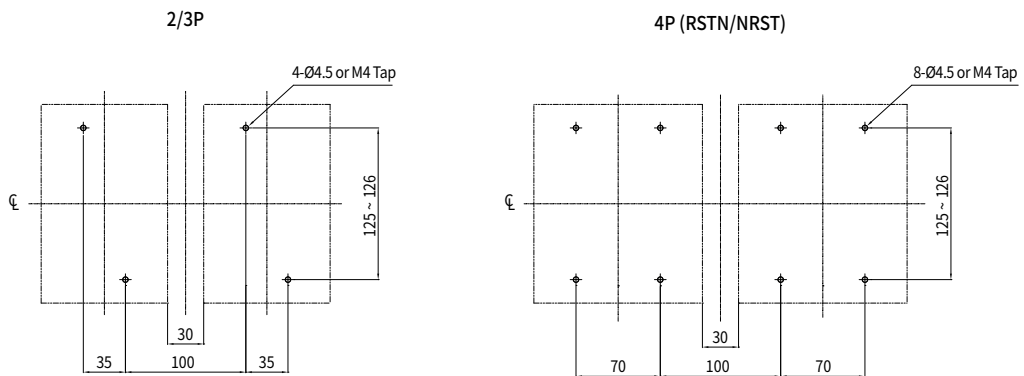

### Dimension of Panel Cover Cutting

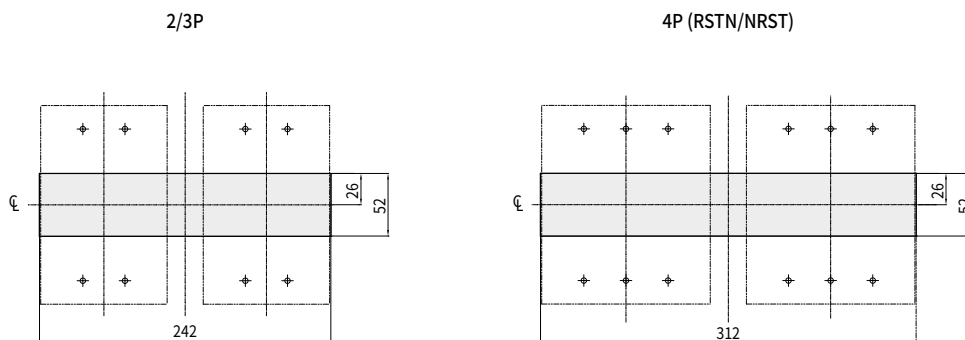

※ When installing the product in close contact, please consider tolerances for external dimensions.

# Dimensions

## Mechanical Interlock HGM400

• HGM400

### External Dimension

Unit : mm

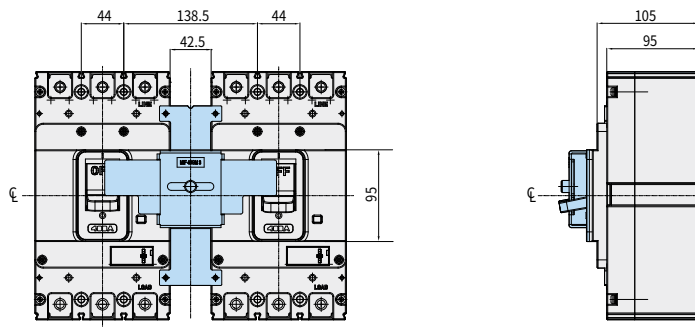

### Panel Installation Dimension

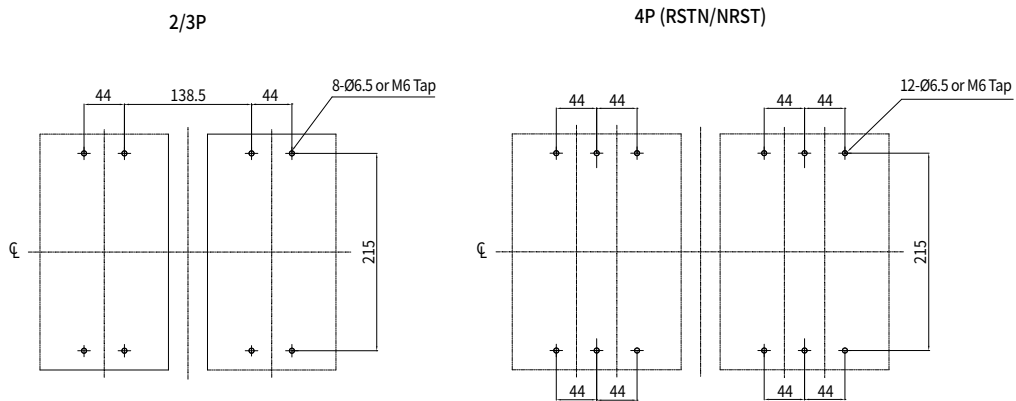

### Dimension of Panel Cover Cutting

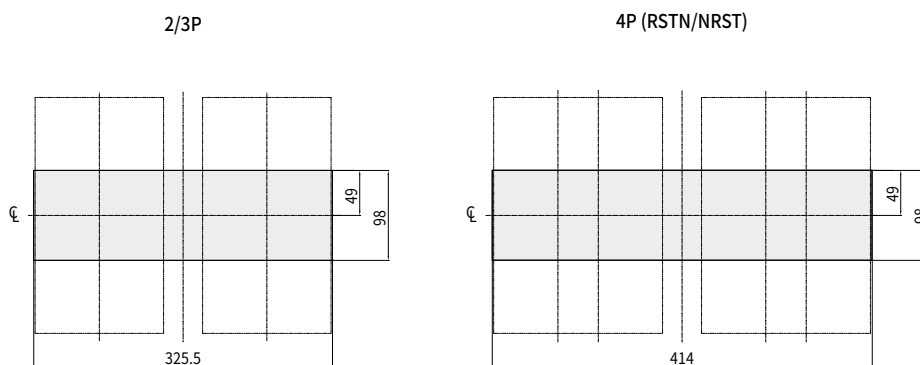

※ When installing the product in close contact, please consider tolerances for external dimensions.



## Mechanical Interlock HGM800

• HGM630, 800

### External Dimension

Unit: mm

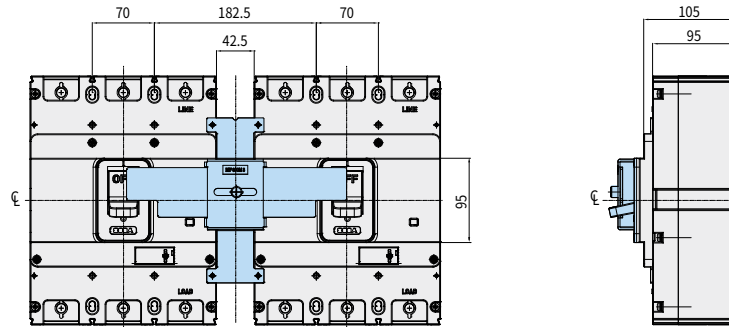

### Panel Installation Dimension

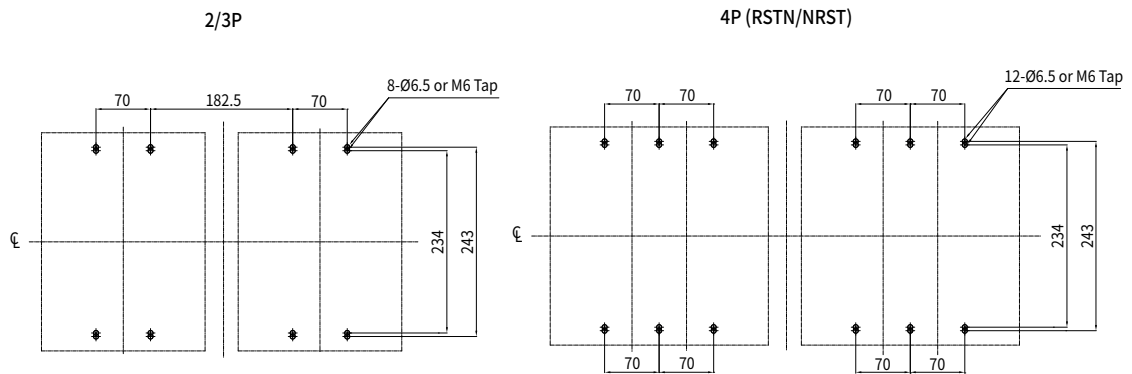

### Dimension of Panel Cover Cutting

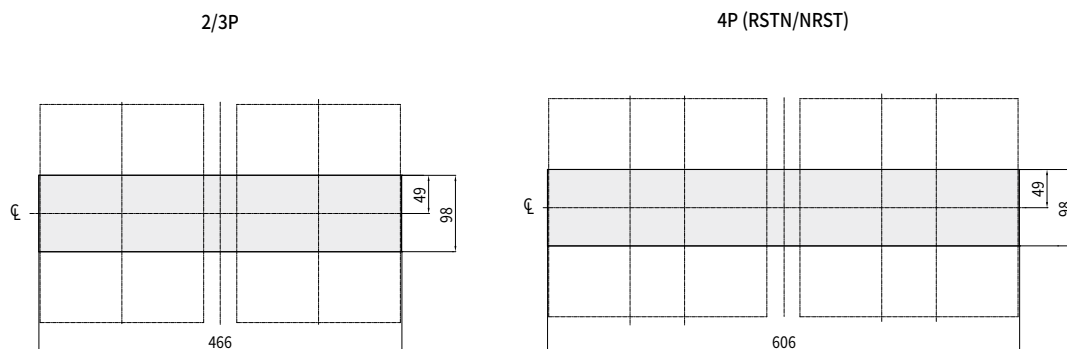

※ When installing the product in close contact, please consider tolerances for external dimensions.

# Dimensions

## Mechanical Interlock HGP160D

• HGP50D, 125D, 160D

### External Dimension

Unit : mm

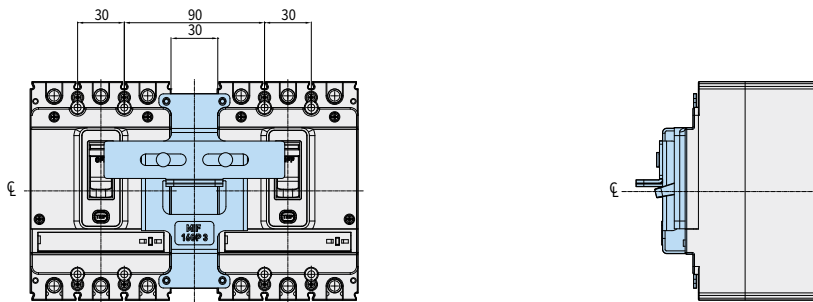

### Panel Installation Dimension

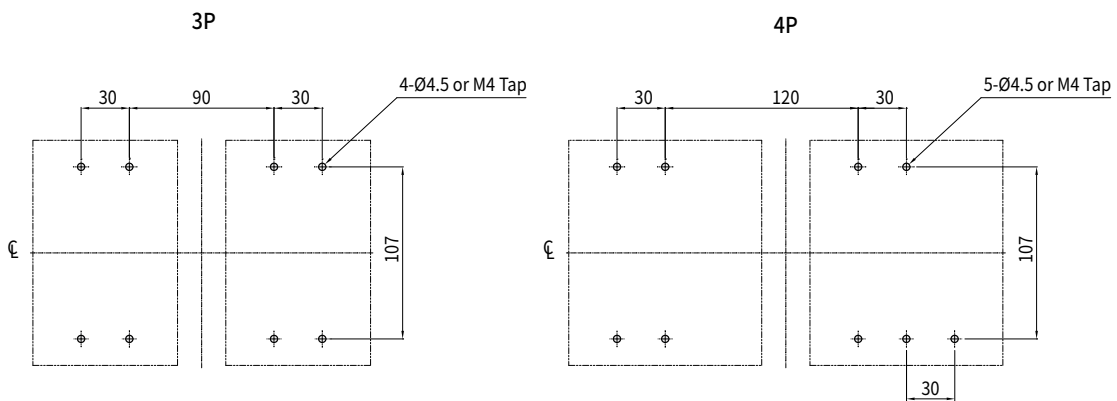

### Dimension of Panel Cover Cutting

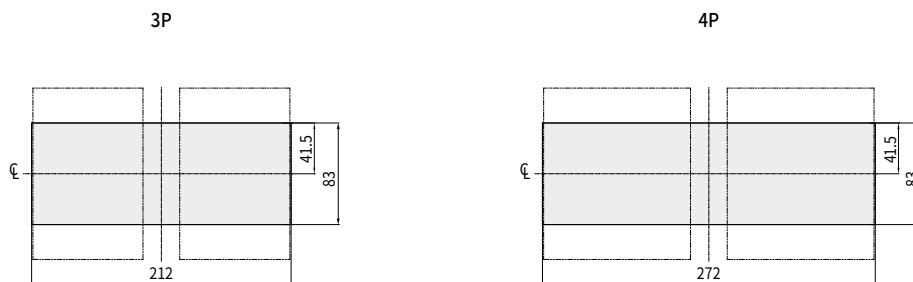

※ When installing the product in close contact, please consider tolerances for external dimensions.

## Mechanical Interlock HGP250

• HGP100, 160, 250

### External Dimension

Unit: mm

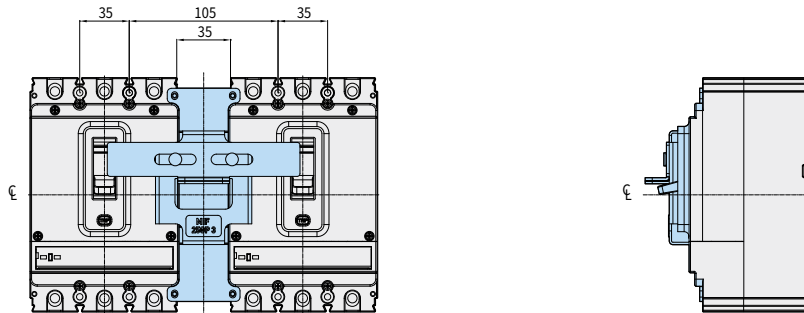

### Panel Installation Dimension

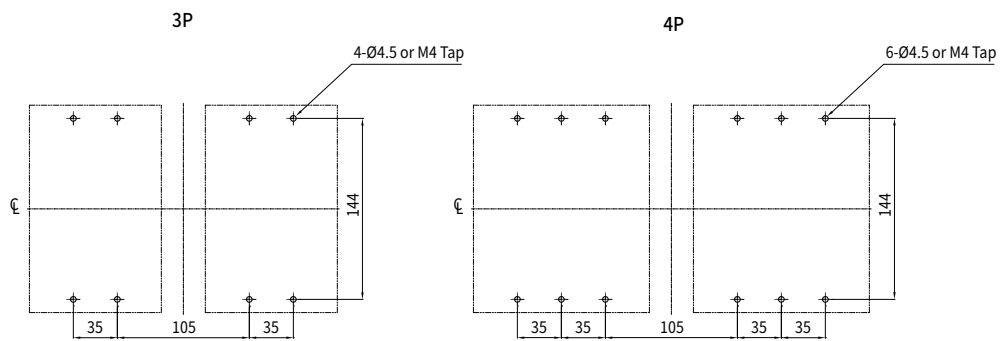

### Dimension of Panel Cover Cutting

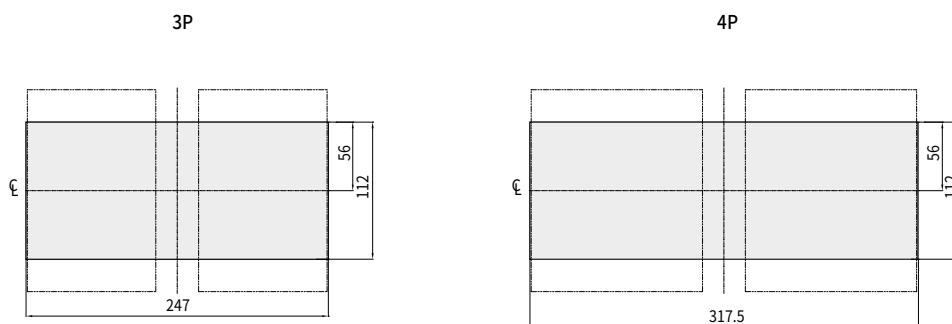

※ When installing the product in close contact, please consider tolerances for external dimensions.

# Dimensions

## Mechanical Interlock HGP630

• HGP400, 630

### External Dimension

Unit : mm

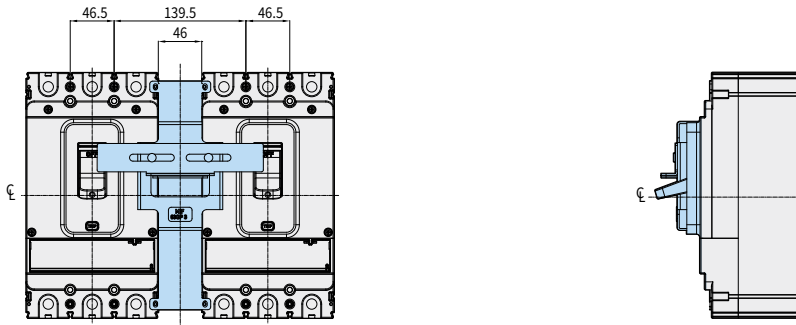

### Panel Installation Dimension

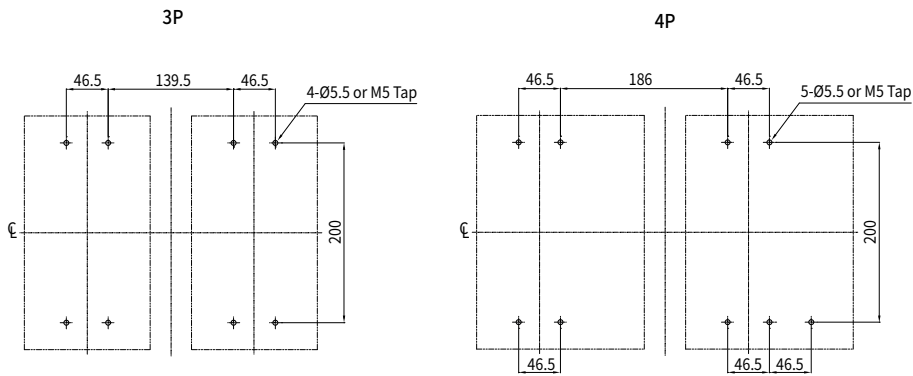

### Dimension of Panel Cover Cutting

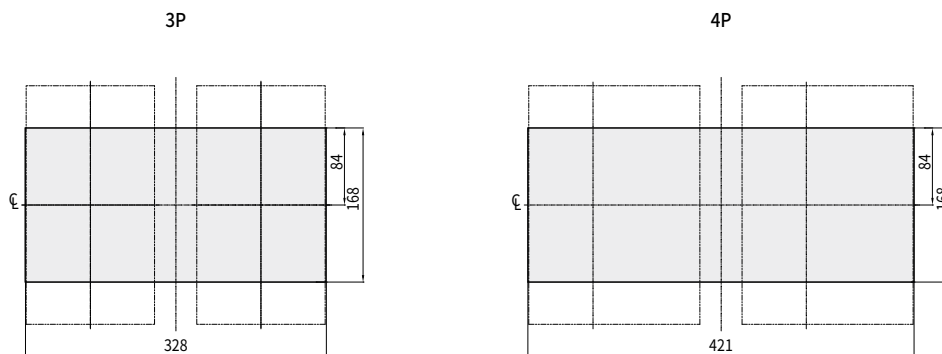

※ When installing the product in close contact, please consider tolerances for external dimensions.

## Mechanical Interlock HGP800

• HGP800

### External Dimension

Unit: mm

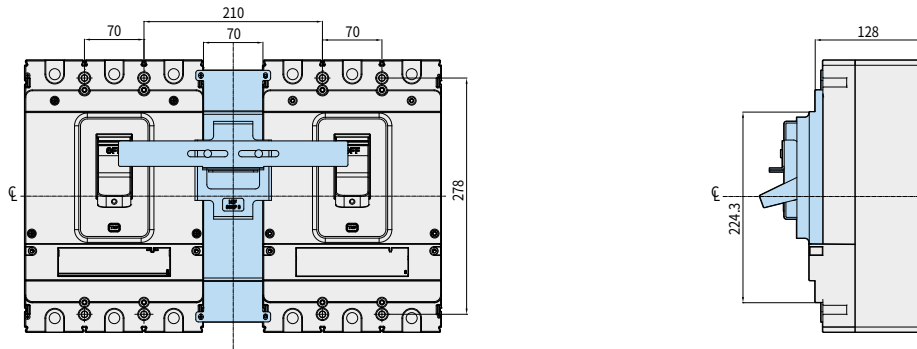

### Panel Installation Dimension

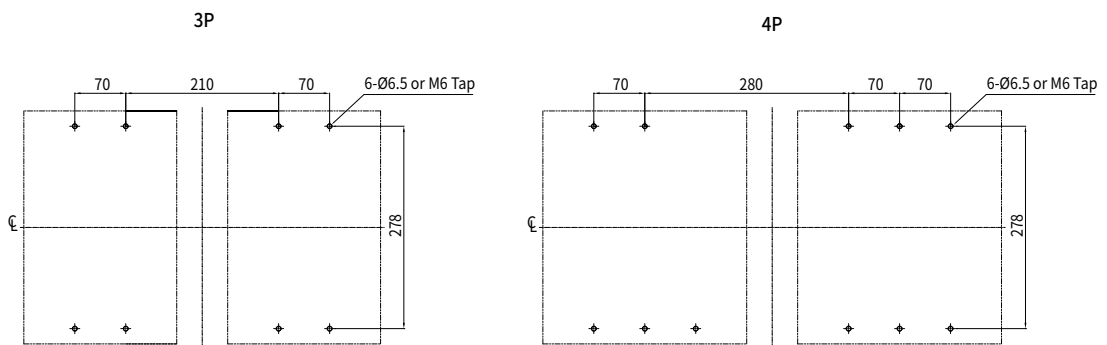

### Dimension of Panel Cover Cutting

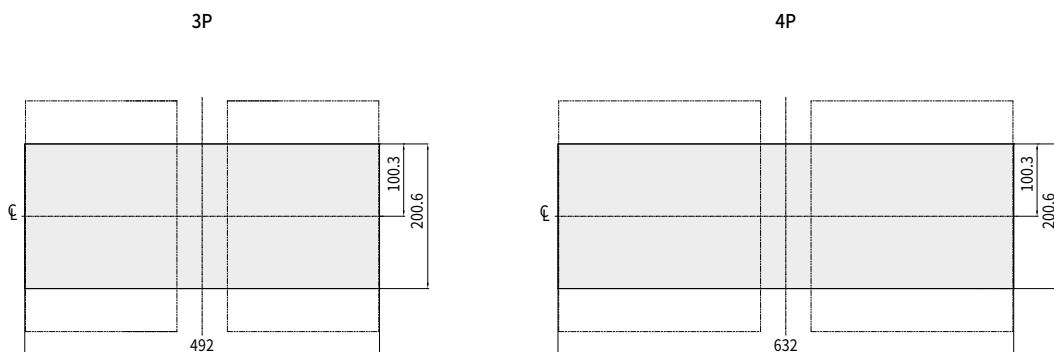

※ When installing the product in close contact, please consider tolerances for external dimensions.

## Dimensions

### Terminal Cover HGM100

• HGM30, 50E/S, 60, 100

Long Type

Short Type

Unit : mm

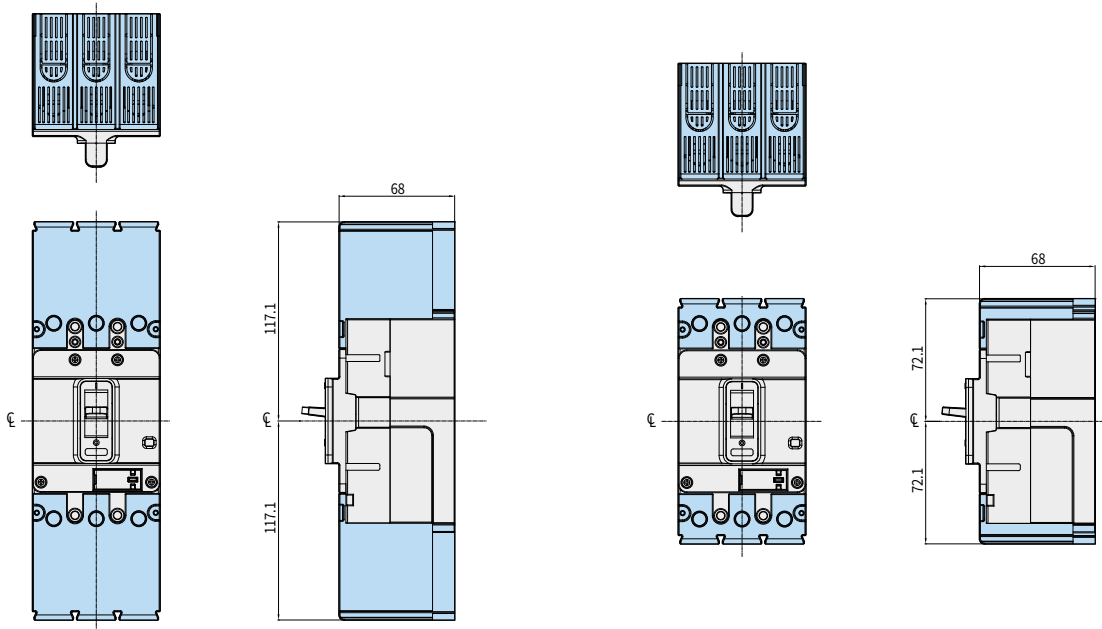

### Terminal Cover HGM125

• HGM50H/L, 125

Long Type

Short Type

Unit : mm

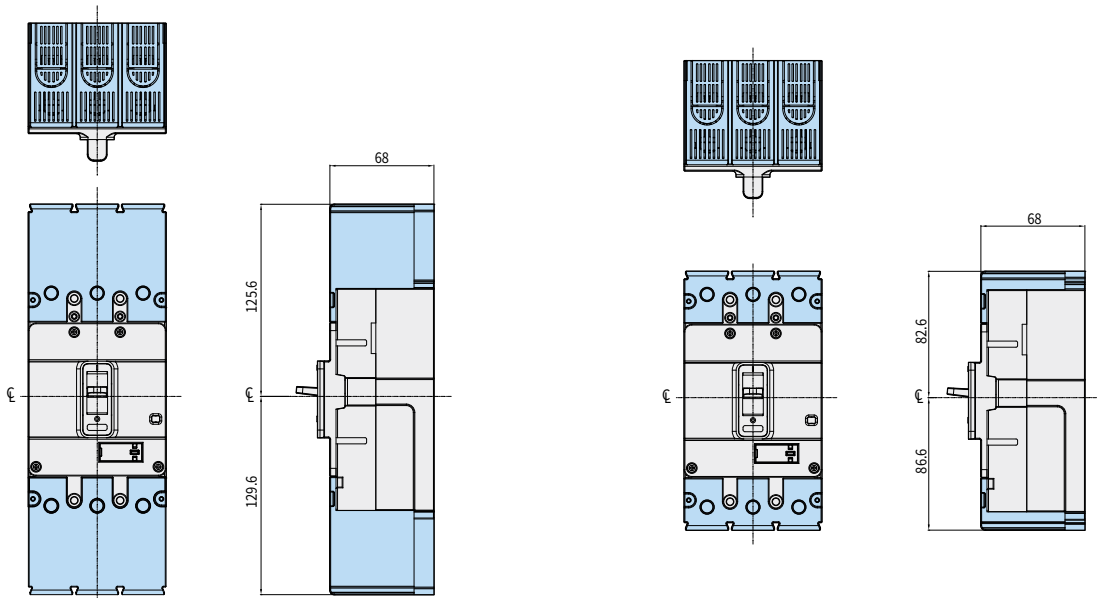

※ When installing the product in close contact, please consider tolerances for external dimensions.

### Terminal Cover HGM250

• HGM160, 250

Long Type

Short Type

Unit: mm

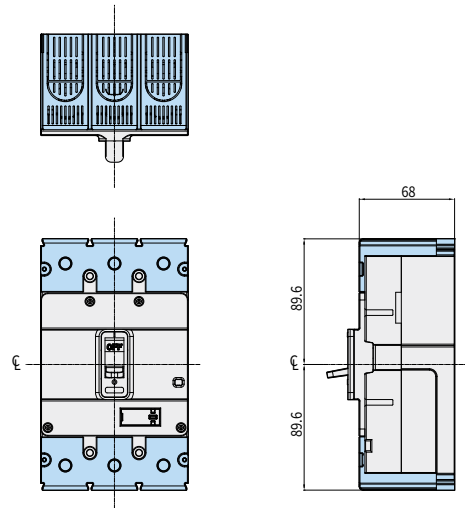
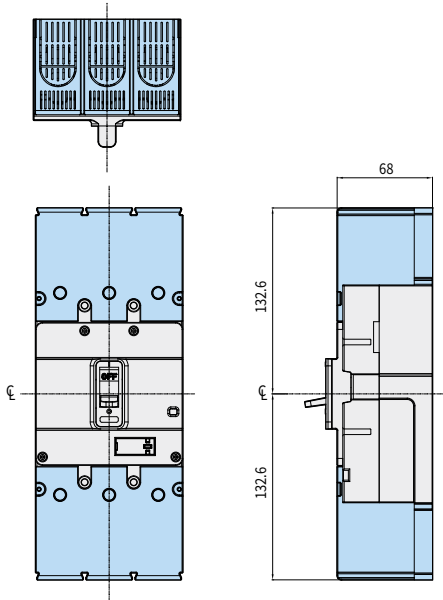

### Terminal Cover HGM400

• HGM400

Long Type

Short Type

Unit: mm

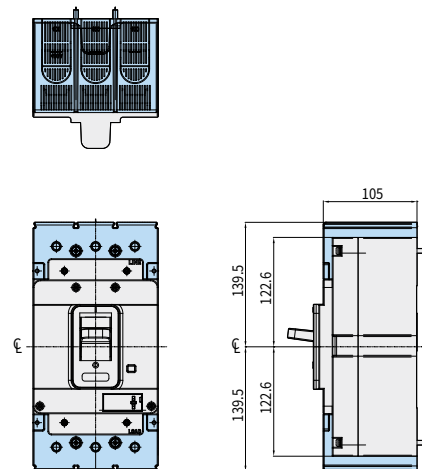
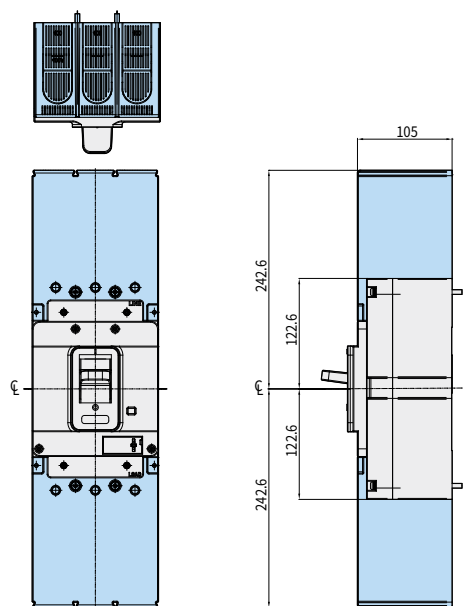

※ When installing the product in close contact, please consider tolerances for external dimensions.

# Dimensions

## Terminal Cover HGM800

• HGM630, 800

Long Type

Short Type

Unit : mm

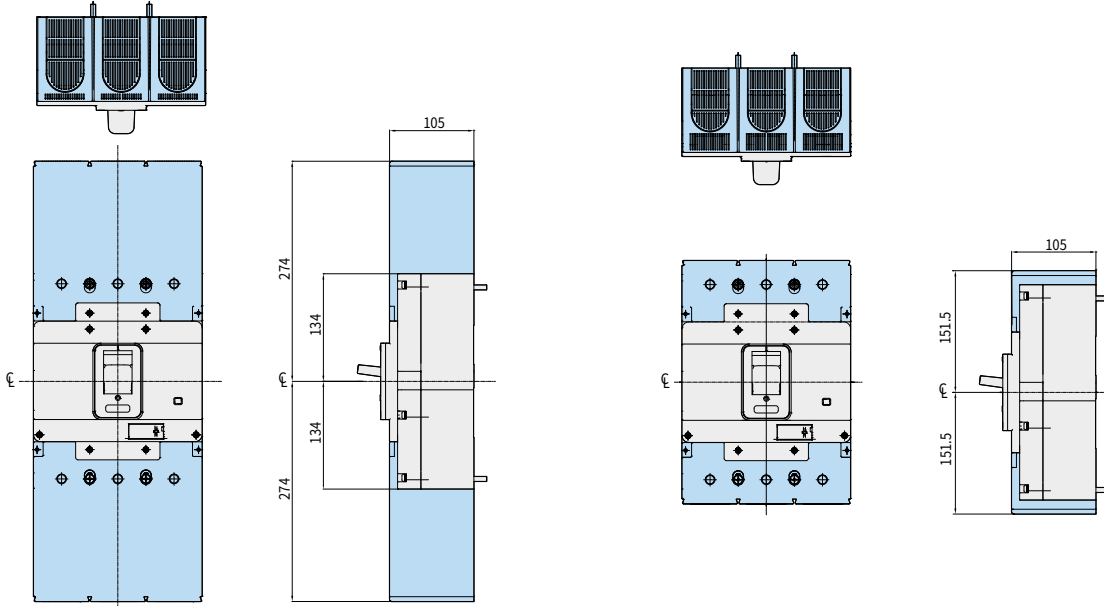

## Terminal Cover HDB100 (for Distribution Panel)

• HDB/HDG30, 50, 100 (for Distribution Panel)

Short Type 2P

Short Type 3P

단위 : mm

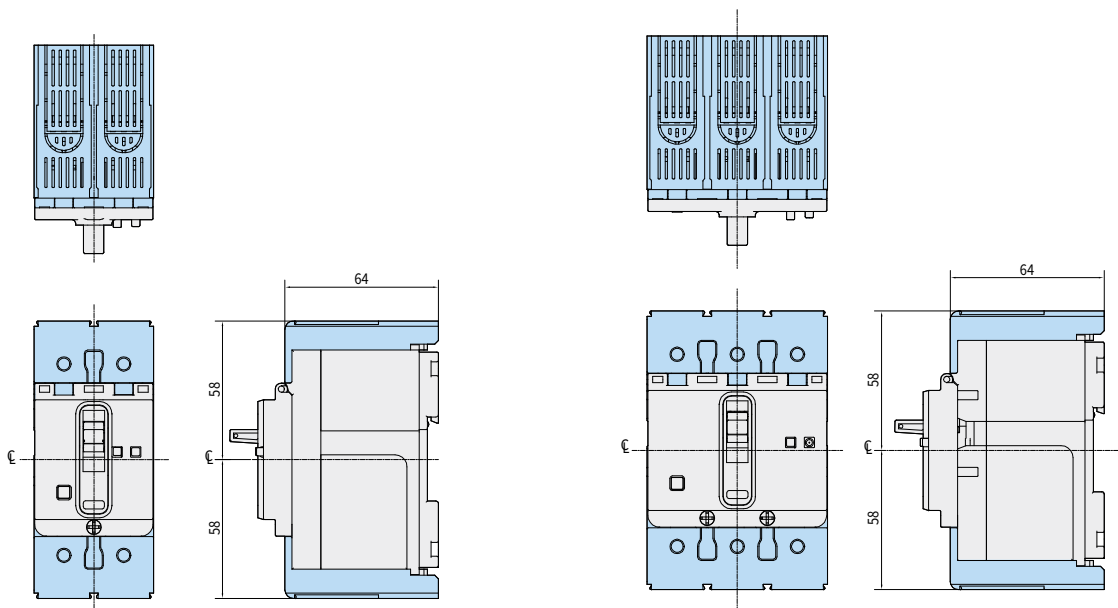

※ When installing the product in close contact, please consider tolerances for external dimensions.



### Terminal Cover HGP50D, 125D, 160D

• HGP50D, 125D, 160D

Long Type 3P/4P

Short Type 3P

Unit: mm

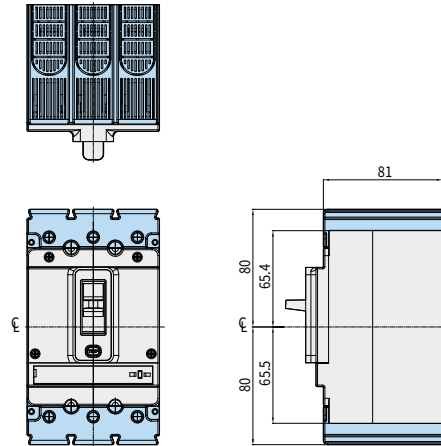
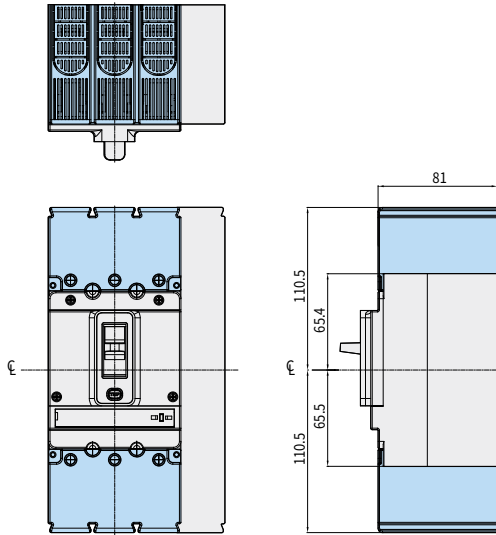

### Terminal Cover HGP250

• HGP100, 160, 250

Long Type 3P/4P

Short Type 3P

Unit: mm

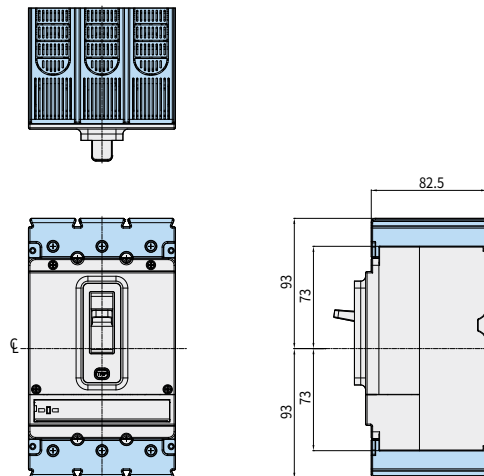
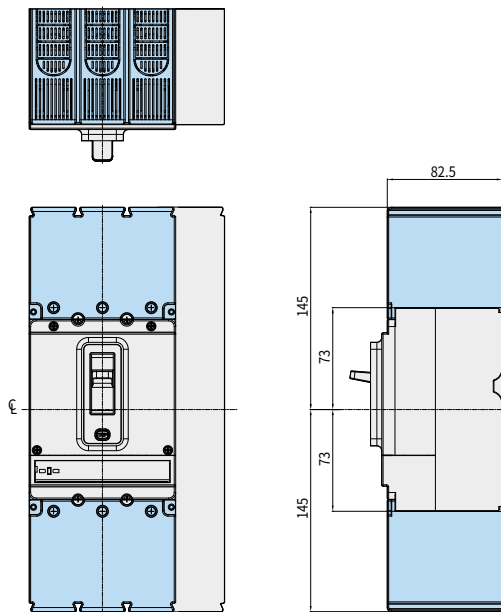

※ When installing the product in close contact, please consider tolerances for external dimensions.

## Dimensions

### Terminal Cover HGP400, 630

• HGP400, 630

Long Type 3P/4P

Short Type 3P

Unit: mm

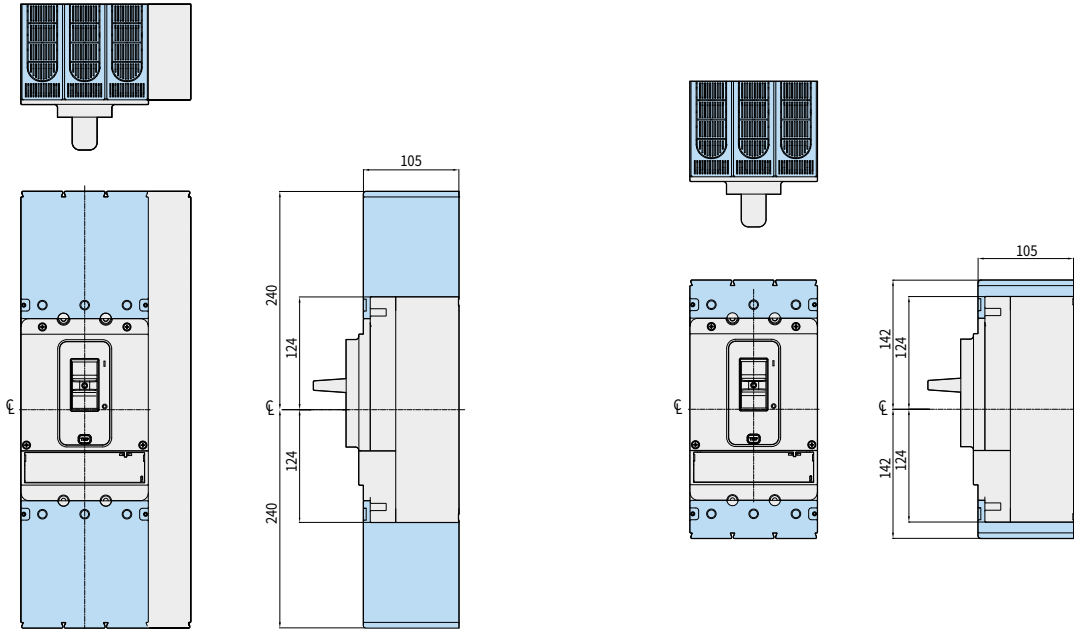

### Terminal Cover HGP800

• HGP800

Long Type 3P/4P

Short Type 3P

Unit: mm

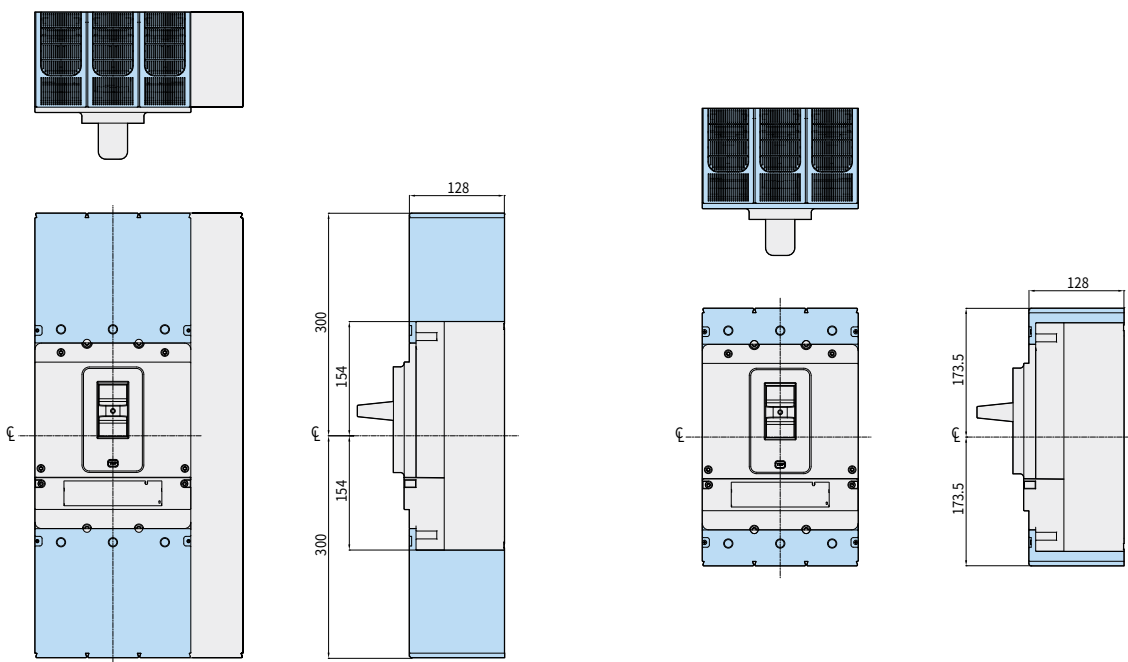

※ When installing the product in close contact, please consider tolerances for external dimensions.

## Motor Operator

HGM30, 50E/S, 60, 100

Unit: mm

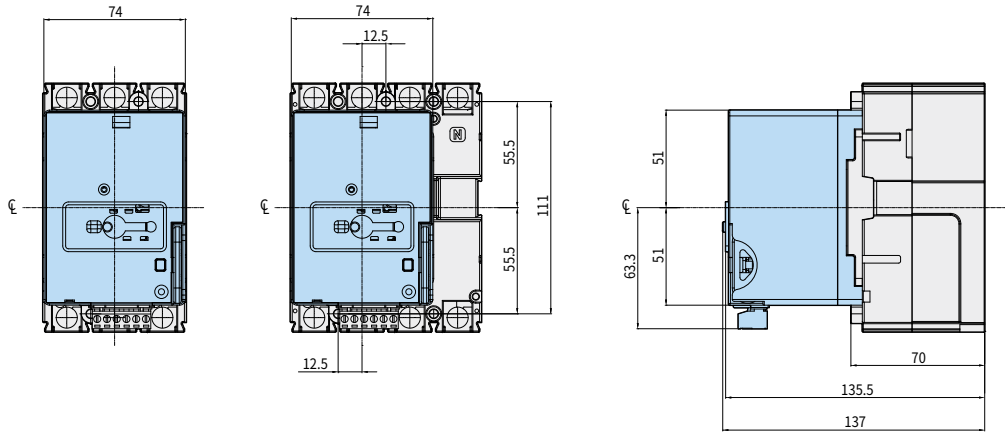

HGM50H/L, 125

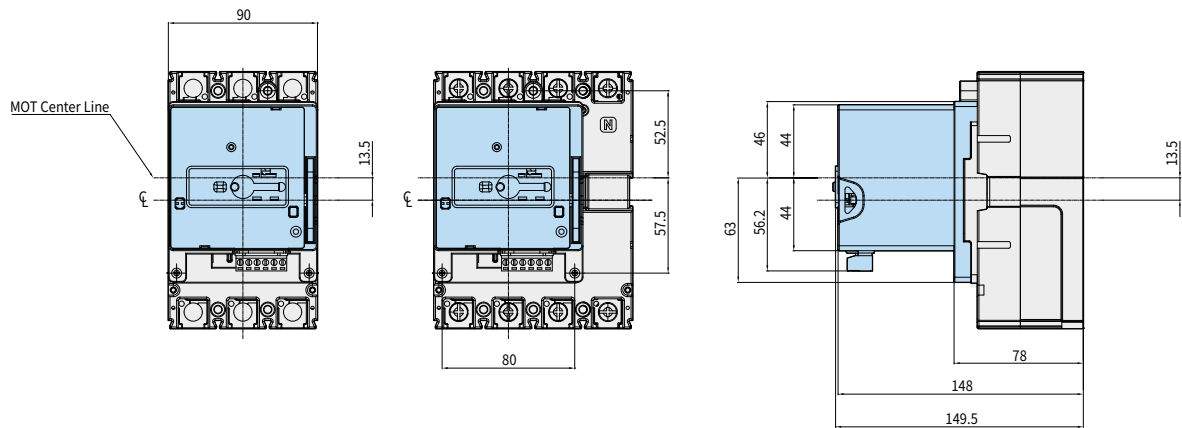

HGM160, 250

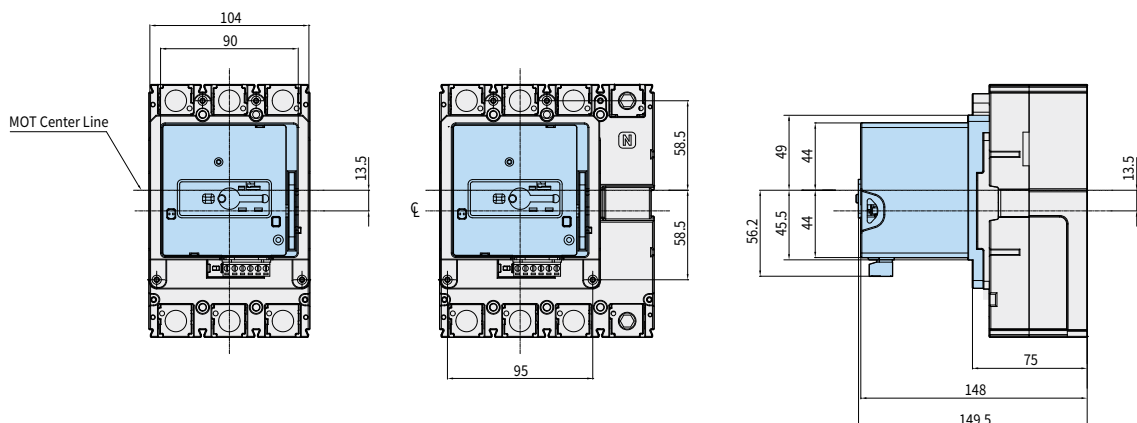

※ When installing the product in close contact, please consider tolerances for external dimensions.

# Dimensions

## Motor Operator

HGM400

Unit : mm

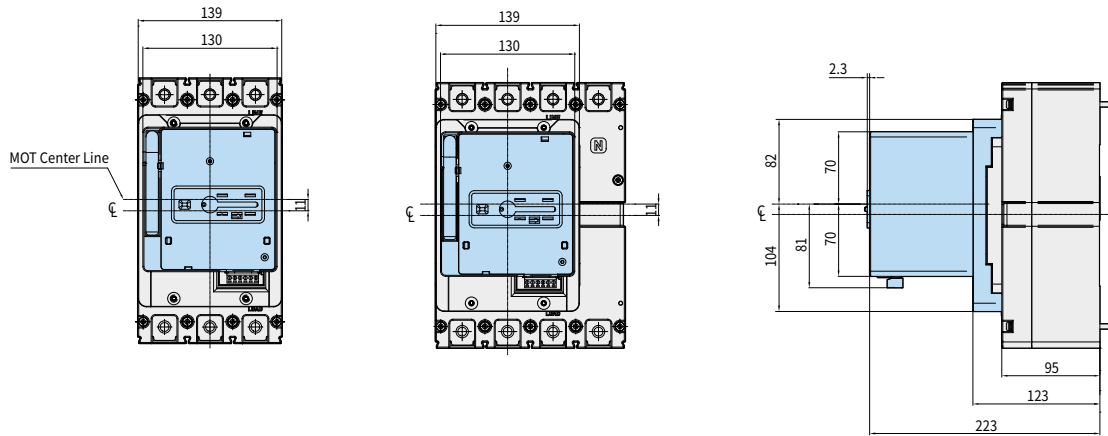

HGM630, 800

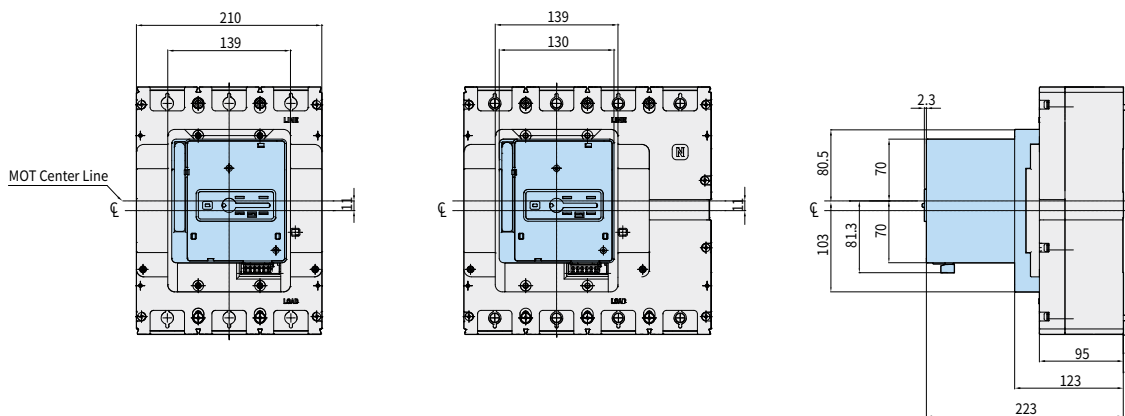

※ When installing the product in close contact, please consider tolerances for external dimensions.

HGP50D, 125D, 160D

Unit: mm

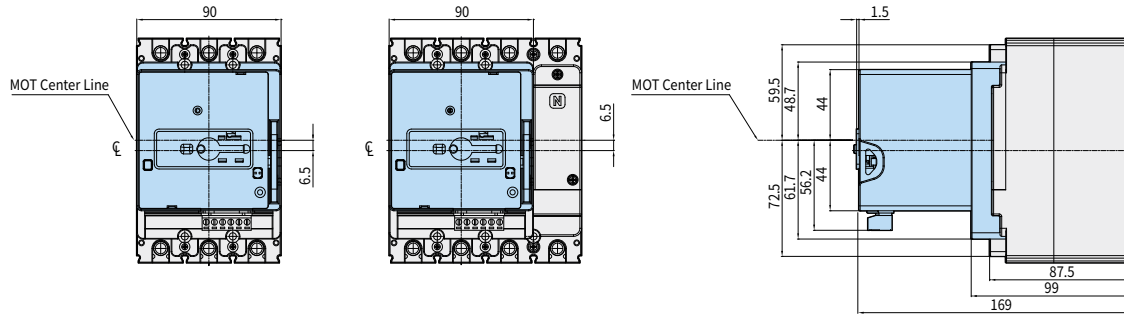

HGP100, 160, 250

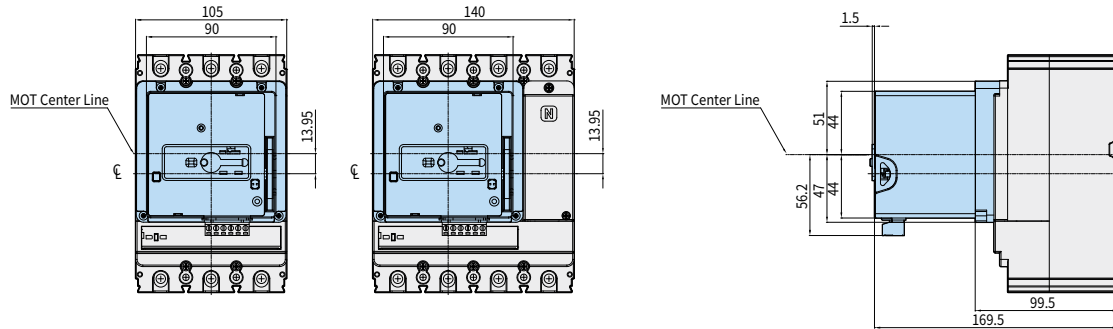

HGP400, 630

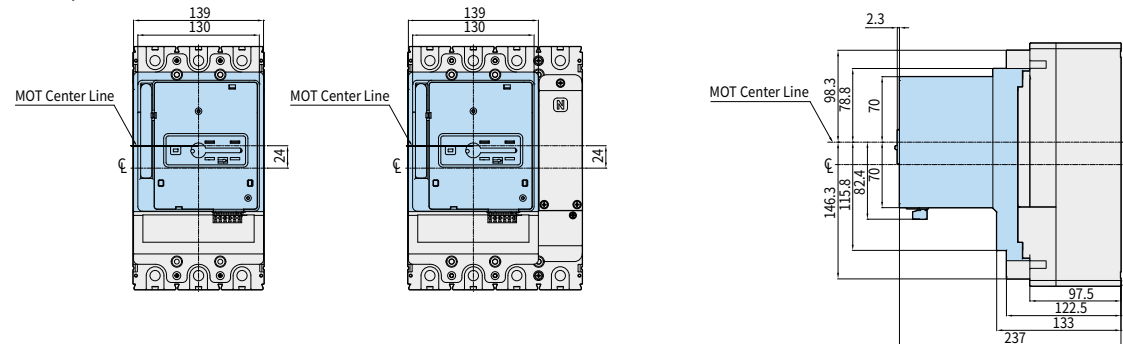

HGP800

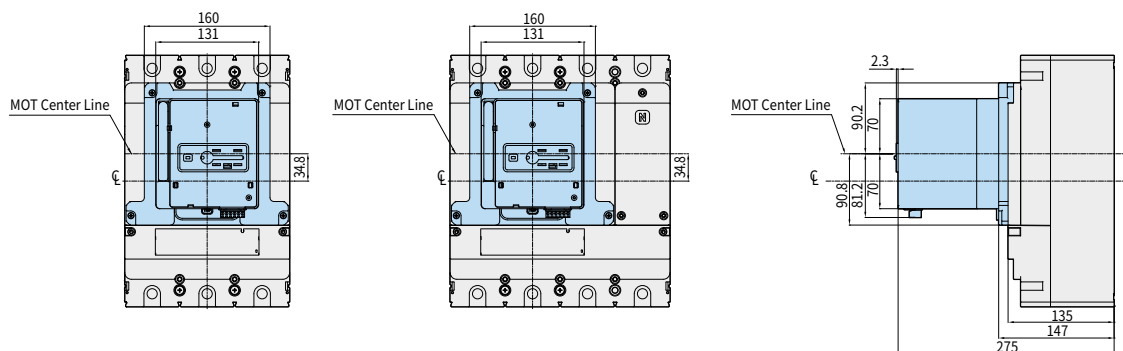

※ When installing the product in close contact, please consider tolerances for external dimensions.

## Dimensions

### LUG Terminal

HGM30, 50E/S, 60, 100

Unit: mm

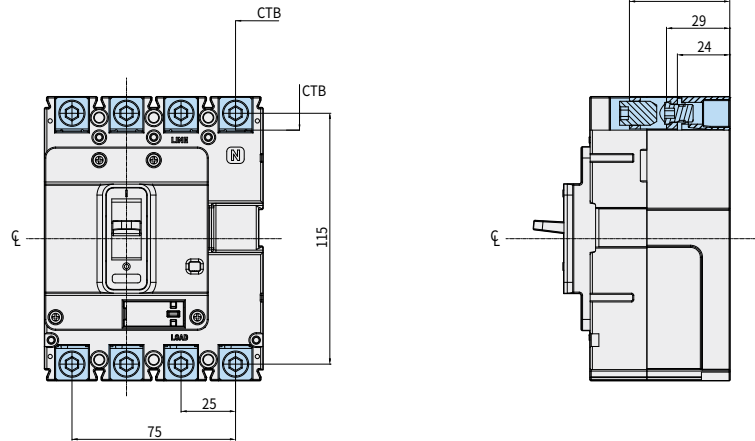

HGM50H/L, 125

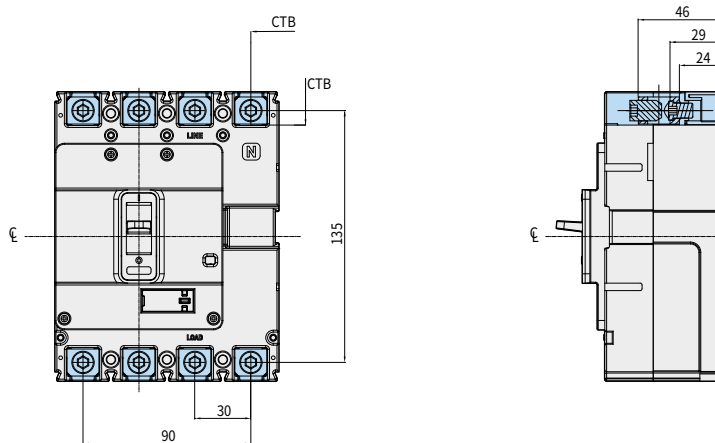

HGM160, 250

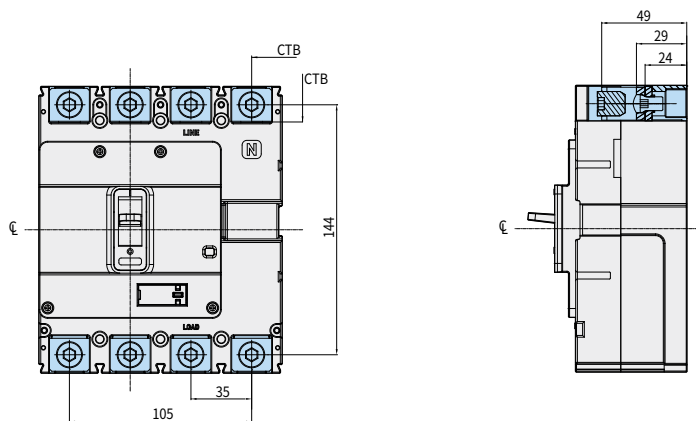

※ When using CTB, in case the Line/Load Insulation Barrier is not mounted, insulation tube or insulation tape does not provide complete insulation between bare conductors which may cause secondary short-circuit accidents so it must be used.

※ When installing the product in close contact, please consider tolerances for external dimensions.

HGM400

Unit: mm

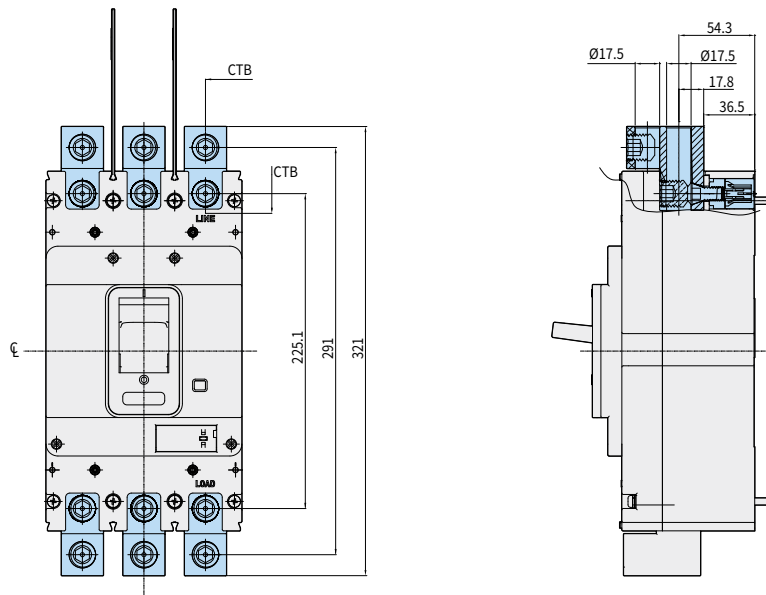

HGM630, 800

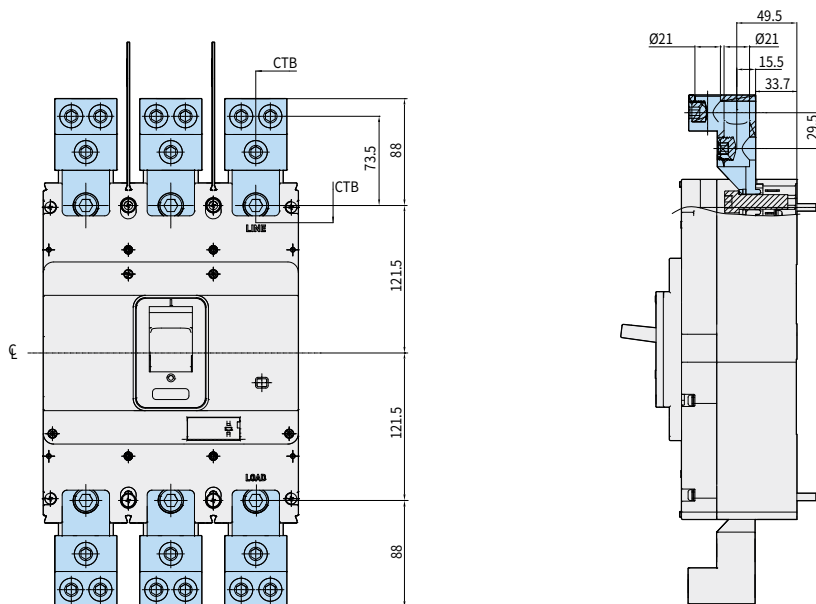

※ When using CTB, in case the Line/Load Insulation Barrier is not mounted, insulation tube or insulation tape does not provide complete insulation between bare conductors which may cause secondary short-circuit accidents so it must be used.  
 ※ When installing the product in close contact, please consider tolerances for external dimensions.

## Dimensions

### LUG Terminal

HGP50D, 125D, 160D

Unit : mm

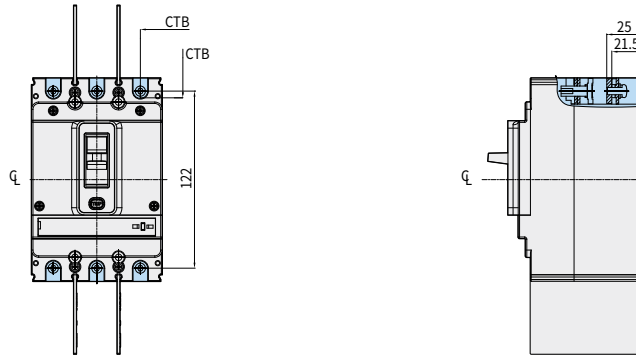

HGP100, 160, 250

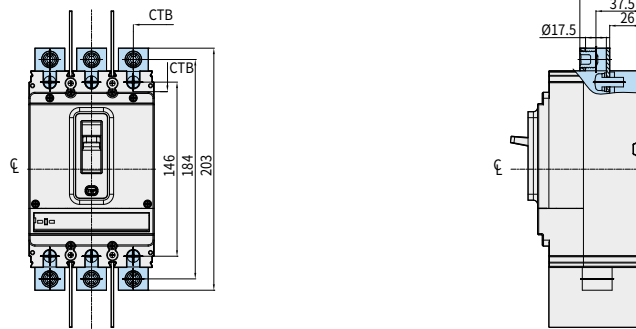

HGP400, 630

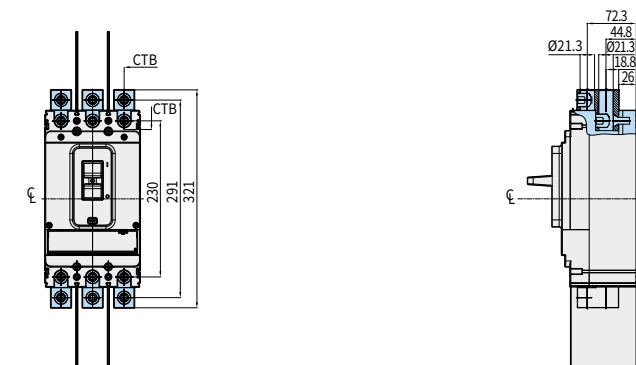

HGP800

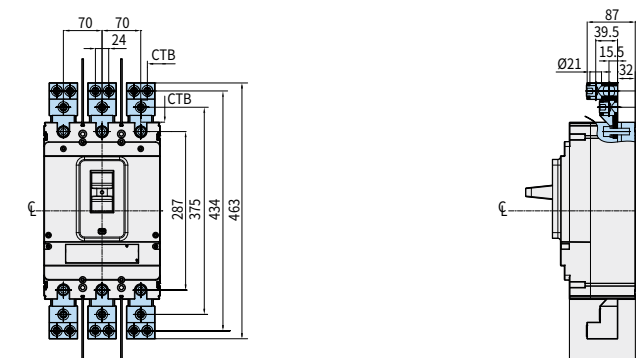

※ When installing the product in close contact, please consider tolerances for external dimensions.



### Series Busbar(SBB) HGP250

• HGP100, 160, 250

#### External Dimension

Unit : mm

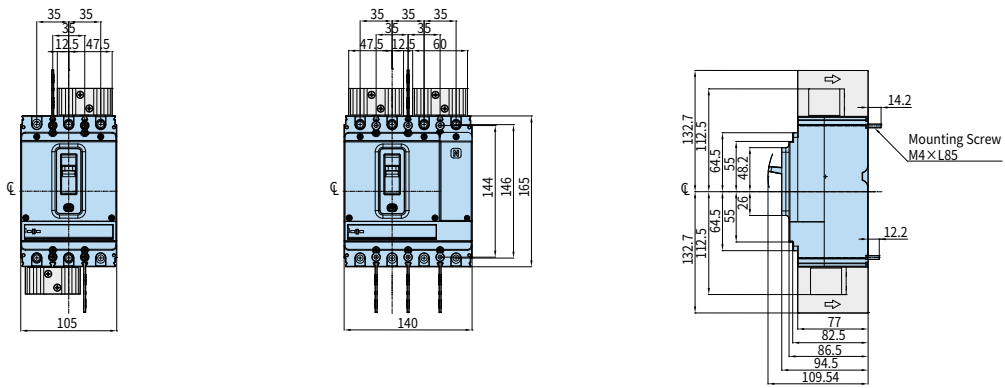

#### Detail Drawing of Terminal Part

#### Detail Drawing of SBB

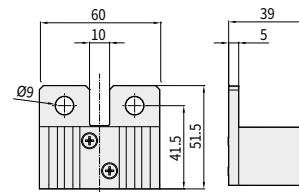
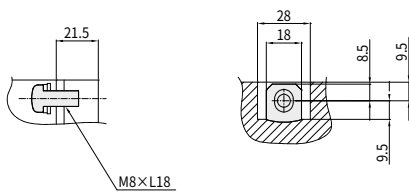

### Series Busbar(SBB) HGP630

• HGP400, 630

#### External Dimension

Unit : mm

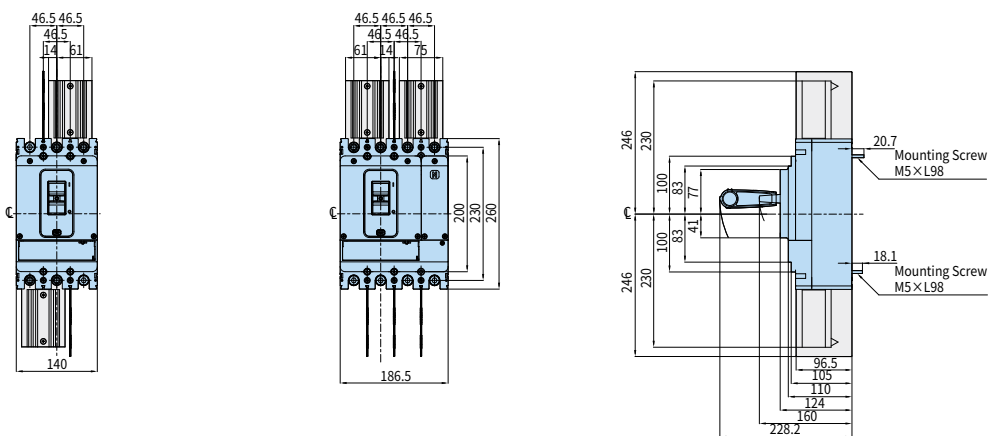

#### Detail Drawing of Terminal Part

#### Detail Drawing of SBB

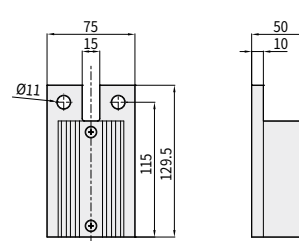
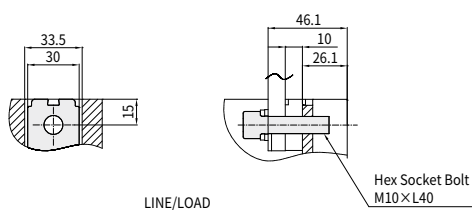

※ When installing the product in close contact, please consider tolerances for external dimensions.

# Dimensions

## Series Busbar(SBB) HGP800

• HGP800

### External Dimension

Unit : mm

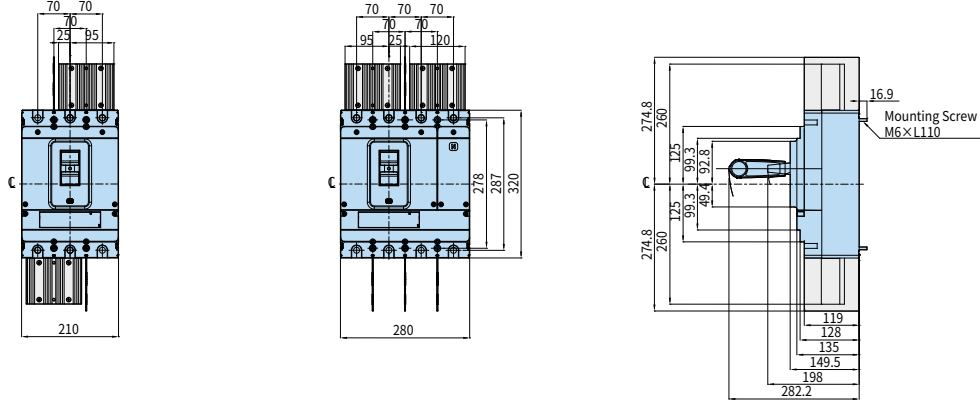

### Detail Drawing of Terminal Part

### Detail Drawing of SBB

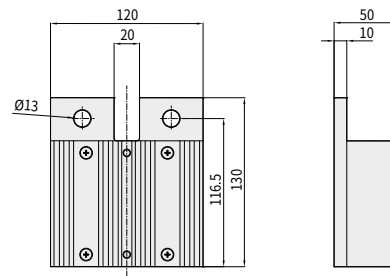
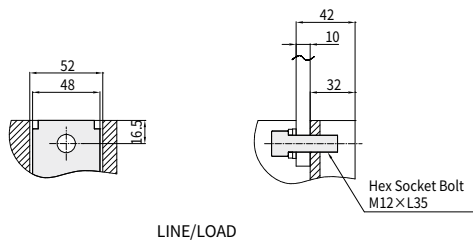

※ When installing the product in close contact, please consider tolerances for external dimensions.

## DIN Rail Adaptor

• HGM100

### Dimension of DIN Rail Mounting Hole

Unit : mm

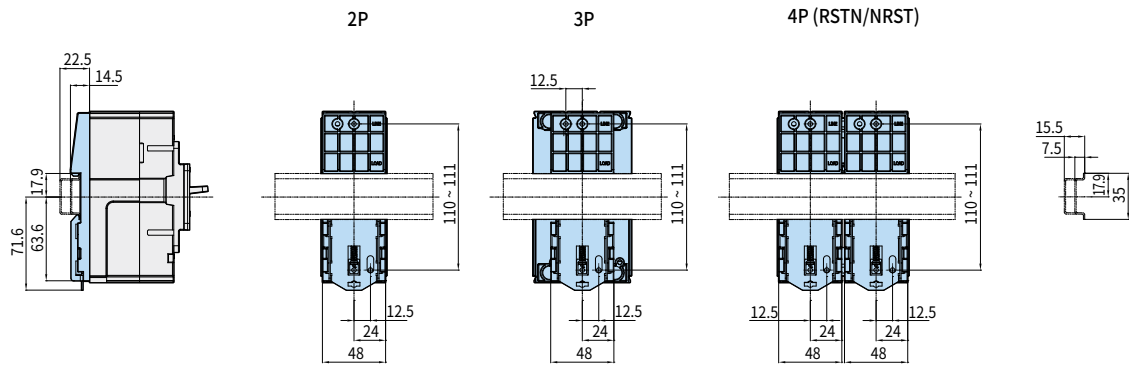

※ When assembling the DRA, remove the back barrier beforehand.  
 ※ When installing the product in close contact, please consider tolerances for external dimensions.

## Order Code

### HGM Type of Molded Case Circuit Breaker, Earth Leakage Circuit Breaker

HGM		50		E		3P		T4		S			
Model Name		Frame Size		Short-Circuit Breaking Category Code		No. of Poles (Category per Circuit Breaker)		Product Category		Connection Method			
HGM	Molded Case Circuit Breaker	30	32 AF	E	E Type	General Type of MCCB/ELCB		MCCB : Ambient Temperature		S	Front Connection		
	HGE	Earth Leakage Circuit Breaker	50	50 AF	S	S Type	2P	2 Pole	T4	40/45 °C	BS <sup>3)</sup>	Terminal Bus Bar (Straight Type)	
60			63 AF	H	H Type	3P	3 Pole	T5	50 °C	BE <sup>4)</sup>	Terminal Bus Bar (Spreader Type)		
100			100 AF	L	L Type	4P	4 Pole (RSTN)	ELCB : Adjustable Residual Current				P	Plug-in
125			125 AF	NA	Switch-Disconnecter	4PN	4 Pole (NRST)	ZCT Embedded Type of MCCB		G4	30 mA	F	Line Side : Plug-in Load Side : Front Connection
160			160 AF			2Z	2 Pole	Instantaneous Circuit Breaker		G5 <sup>1)</sup>	100 mA		
250			250 AF			3Z	3 Pole	Switch-Disconnecter		MO <sup>2)</sup>	Instantaneous		
400			400 AF			4Z	4 Pole	Switch-Disconnecter		DS	Switch-Disconnecter		
630			630 AF										
800	800 AF												

※ 1) In case of 100/300/500/1,000 mA adjustable and time delay type, place order as 100 mA.

2) As for instantaneous products, only 3P can be ordered.

3) Only for 400 ~ 800 AF.

4) Only for 400 AF.

5) Rated current of instantaneous products : Above 40 A

00		00		C	00016		F	
Signal Device (AUX/ALT)		Trip Device (SHT/UVT)		Frequency	Rated Current <sup>5)</sup>		Trip Device Characteristics (Applicable To MCCB Only)	
<b>00</b>	Not Attached	HGM/HGE 30 ~ 250 AF		<b>C</b>	<b>00016</b>	16 A	For Protecting Overload Short-Circuit	
<b>10</b>	AUX 1C	<b>00</b>	Not Attached		<b>00020</b>	20 A		
<b>20</b>	AUX 2C	<b>S1</b>	SHT AC 100 - 120 V				-	Thermal Fixed/ Instantaneous Fixed
<b>01</b>	ALT 1C	<b>S2</b>	SHT AC 200 - 250 V					
<b>11</b>	AUX 1C + ALT 1C	<b>S3</b>	-				<b>F</b>	Thermal Adjustable/ Instantaneous Fixed
<b>21</b>	AUX 2C + ALT 1C	<b>S4</b>	SHT AC 380 - 480 V		<b>00800</b>	800 A		Instantaneous
		<b>S5</b>	SHT DC 24 V				<b>B</b>	Instantaneous Fixed (10×In)
		<b>S6</b>	SHT DC 100 - 120 V					Switch-Disconnecter
		<b>S7</b>	SHT DC 48 V				-	No Protection Function
		<b>S8</b>	SHT DC 60 V					
		<b>S9</b>	SHT DC 125 V					
		<b>U1</b>	UVT AC 100 - 120 V					
		<b>U2</b>	UVT AC 200 - 230 V					
		<b>U3</b>	UVT AC 380 - 415 V					
		<b>U4</b>	UVT AC 440 - 480 V					
		<b>U5</b>	UVT DC 24 V					
		<b>U6</b>	UVT DC 100 - 110 V					
		<b>U7</b>	UVT DC 48 V					
		HGM/HGE 400 ~ 800 AF						
		<b>00</b>	Not Attached					
		<b>S1</b>	SHT AC 100 - 120 V					
		<b>S2</b>	SHT AC 200 - 230 V					
		<b>S3</b>	SHT AC 380 - 415 V					
		<b>S4</b>	SHT AC 440 - 480 V					
		<b>S5</b>	SHT DC 24 V					
		<b>S6</b>	SHT DC 100 - 110 V					
		<b>U1</b>	UVT AC 100 - 120 V					
		<b>U2</b>	UVT AC 200 - 230 V					
		<b>U3</b>	UVT AC 380 - 415 V					
		<b>U4</b>	UVT AC 440 - 480 V					
		<b>U5</b>	UVT DC 24 V					
		<b>U6</b>	UVT DC 100 - 110 V					

## Order Code

### HGP Type of Molded Case Circuit Breaker / Switch Disconnecter

HGP		250		X		-G		3P		T4		S		
Model Name		Frame Size		Short-Circuit Breaking Category Code <sup>1)</sup>		Classification-250 AF		No. of Poles		Product Category		Connection Method		
HGP	Molded Case Circuit Breaker / Earth Leakage Circuit Breaker	50D	50 AF	AC		-	Terminal Height (24-26 mm) <sup>10)</sup>	3P	AC 3 pole	Molded Case Circuit Breaker	S		Front Connection	
		125D	125 AF	F <sup>8)</sup>	36 kA			4P	AC 4 pole		BS <sup>4)</sup>	Straight Type of Bus Bar Packaging		
		160D	160 AF	S	65 <sup>6)</sup> / 70 <sup>7)</sup> kA	-G <sup>2)</sup>	New Type Terminal Height (21.5 mm)	D3	DC 3 pole		T4 <sup>9)</sup>	Ambient Temperature of 40 °C	BE <sup>11)</sup>	Spreader Type of Bus Bar Packaging
		100	100 AF	H	85 kA			D4	DC 4 pole		T5	Ambient Temperature of 50 °C	P	Plug-in PC/CBM Attached
		160	160 AF	X	150 kA						Electronic <sup>3)</sup>		F	Line Side: Plug-in Load Side: Front Connection
		250	250 AF	NA	Switch-Disconnecter								X	Plug-in PC/CBM Not Attached
		400	400 AF	DC										
		630	630 AF	F	10 kA									
		800	800 AF	S	55 kA									
				H	85 kA									
		X	100 kA											
										Motor Protection				
										MP		For Motor Protection		
										Switch-Disconnecter				
										DS		Switch-Disconnecter		

※ 1) Based on AC 440/460 V

2) For HGP100,160,250 AC,DC mechanical / electronic type only (Can't be applicable to 50D,125D,160D, 250 of motor protection and etc.)

3) 50D, 125D, 160D : Electronic type N/A

4) Applicable to both Line part / Load part, HGP400~800

5) Applicable to HGP400 ~ 800

6) HGP50D, 125D, 160D, 100, 160, 250 AF

7) HGP400, 630, 800 AF

8) F type is for overseas and ship.

9) For DC products, only T4 is applicable.

10) Discontinued March 2020

11) Applicable to both Line part / Load part, HGP400

00		00		C		00016		F	
Signal Device (AUX/ALT)		Trip Device (SHT/UVT)		Frequency		Rated Current		Trip Device Characteristics	
00	Not Attached	00	Not Attached	C	50/60 Hz	002.5	2.5 A	For Protecting Overload Short-Circuit	
10	AUX 1C	S1	SHT AC 100 - 120 V	Z	DC	006.3	6.3 A	-	Thermal Fixed/Instantaneous Fixed (MTM - FF)
20	AUX 2C	S2	SHT AC 200 - 230 V				.	F	Thermal Adjustable/Instantaneous Fixed (MTM - JF)
01	ALT 1C	S3	SHT AC 380 - 415 V				:	H	Thermal Adjustable/Instantaneous Adjustable (MTM - JJ)
11	AUX 1C + ALT 1C	S4	SHT AC 440 - 480 V			00800	800 A	N	Thermal Fixed/Instantaneous Fixed (MTM - FF) + 4P N Phase Protection
21	AUX 2C + ALT 1C	S5	SHT DC 24 V					FN	Thermal Adjustable/Instantaneous Fixed (MTM - JF) + 4P N Phase Protection
31 <sup>5)</sup>	AUX 3C + ALT 1C	S6	SHT DC 100 - 110 V					HN	Thermal Adjustable/Instantaneous Adjustable (MTM - JJ) + 4P N Phase Protection
32 <sup>5)</sup>	AUX 3C + ALT 2C	U1	UVT AC 100 - 120 V					Electronic	
		U2	UVT AC 200 - 230 V					-	Not Applicable (ETU)
		U3	UVT AC 380 - 415 V					Motor Protection	
		U4	UVT AC 440 - 480 V					-	No Thermal/Instantaneous Adjustable (MCP - OJ)
		U5	UVT DC 24 V					Switch-Disconnecter	
		U6	UVT DC 100 - 110 V					-	No Protection Function (DSU)

## Order Code of Accessories

### HGM/HGE Type of Accessory Unit

#### HGM/HGE30, 50E/S, 60, 100

##### Connection Method

		2 Pole	3 Pole	4 Pole
Plug-in	TDM (LINE/LOAD)	-	TDM 10GM P3	-
	TDM (LINE Only)	-	TDM 10GM F3	-
	TDF (LINE Only)	-	TDF 10GM 3	-
	TDA (1 row)	-	TDA 10GM S3	-
	TDA (2 rows)	TDA 10GM D2	TDA 10GM D3	-
Conn. Block (CBM)	CBM 10GM 2P UNIT	CBM 10GM UNIT	-	
CBB BLOCK UNIT	-	CBB BLOCK UNIT CBB BLOCK UNIT2C	-	
CBB PLATE	-	CBBPLATE 10GM	-	
PC MALE	-	PCMALE 10GM 50 A ( $\leq 50$ A) PCMALE 10GM 100 A ( $> 50$ A)	-	
Terminal Busbar (TBB)	Straight Busbar	-	-	-
	Spreader Busbar	-	-	-
Rear Connection Terminal (RCT)	LINE/LOAD ( $\leq 50$ A)	RCT 05GM F2	RCT 05GM F3	RCT 05GM F4
	LINE/LOAD ( $> 50$ A)	RCT 10GM F2	RCT 10GM F3	RCT 10GM F4
Cage Terminal (CTB)	( $\leq 50$ A) inch	CTB 10GM 2S50	CTB 10GM 3S50	CTB 10GM 4S50
	( $> 50$ A) inch	CTB 10GM 2S100	CTB 10GM 3S100	CTB 10GM 4S100
	( $\leq 50$ A) mm	CTB 10GM 2S50-MM	CTB 10GM 3S50-MM	CTB 10GM 4S50-MM
	( $> 50$ A) mm	CTB 10GM 2S100-MM	CTB 10GM 3S100-MM	CTB 10GM 4S100-MM
Din Rail Adaptor (DRA)	DRA 10GM	DRA 10GM	DRA 10GM	

##### Internal Accessory

		Auxiliary Switch (AUX)	Alarm Switch (ALT)	Auxiliary/Alarm (AXT)
Indication Contacts		AUX 10GM C1	ALT 10GM L1	AXT 10GM L1
		AUX 10GM C2	ALT 10GM R1	AXT 10GM R1
Remote Tripping		Shunt Trip (SHT)		
		SHT 10GM DC 24 V	Under-Voltage Trip (UVT)	
		SHT 10GM DC 100 - 120 V	UVT 10GM DC 24 V	
		SHT 10GM DC 48 V	UVT 10GM DC 100 - 110 V	
		SHT 10GM DC 60 V	UVT 10GM DC 48 V	
		SHT 10GM DC 125 V	UVT 10GM AC 100 - 120 V	
		SHT 10GM AC 100 - 120 V	UVT 10GM AC 200 - 230 V	
		SHT 10GM AC 200 - 250 V	UVT 10GM AC 380 - 415 V	
		SHT 10GM AC 380 - 480 V	UVT 10GM AC 440 - 480 V	

##### External Accessory

		Front Contact (TFG)	Extension (TFH)	
Rotary Handle	Upper Line	TFG 10GM U	TFH 10GM	
	Right Line	TFG 10GM R	TFH 10GM	
	Left Line	TFG 10GM L	TFH 10GM	
Motor Operator <sup>1)</sup>		2 Pole	3 Pole	4 Pole
		-	MOT 10GM DC 24 V	
		-	MOT 10GM AC/DC 110 V	
Terminal Cover	Short	TCF 10GM S2	TCF 10GM S3	TCF 10GM S4
	Long	TCF 10GM L2	TCF 10GM L3	TCF 10GM L4
Locking Device		2 Pole	3 Pole	4 Pole RSTN / NRST
	Padlock	PLD 10GM	PLD 10GM	PLD 10GM
	Mechanical Interlock	MIF 10GM 2	MIF 10GM 3	MIF 10GM R4 / MIF 10GM N4
Interpole Barrier		2 Pole	3 Pole	4 Pole
Auxiliary Handle		TQQ 10GM 2	TQQ 10GM 3	TQQ 10GM 4

※ 1) For HGM only.



**HGM/HGE50H/L, 125****Connection Method**

		2 Pole	3 Pole	4 Pole
Plug-in	TDM (LINE/LOAD)	-	TDM 12GM P3	-
	TDM (LINE Only)	-	TDM 12GM F3	-
	TDF (LINE Only)	-	TDF 12GM 3	-
	TDA (1 row)	-	TDA 12GM S3	-
	TDA (2 rows)	-	TDA 12GM D3	-
Conn. Block (CBM)		-	CBM 10GM UNIT	-
CBB BLOCK UNIT		-	CBB BLOCK UNIT CBB BLOCK UNIT2C	-
CBB PLATE		-	CBBPLATE 10GM	-
PC MALE		-	PCMALE 12GM	-
Terminal Busbar (TBB)	Straight Busbar	-	-	-
	Spreader Busbar	-	-	-
Rear Connection Terminal (RCT)	LINE/LOAD	RCT 12GM F2	RCT 12GM F3	RCT 12GM F4
Cage Terminal (CTB)	inch	CTB 12GM 2S	CTB 12GM 3S	CTB 12GM 4S
	mm	CTB 12GM 2S-MM	CTB 12GM 3S-MM	CTB 12GM 4S-MM
Din Rail Adaptor (DRA)		-	-	-

**Internal Accessory**

		Auxiliary Switch (AUX)	Alarm Switch (ALT)	Auxiliary/Alarm (AXT)
Indication Contacts		AUX 10GM C1	ALT 10GM L1	AXT 10GM L1
		AUX 10GM C2	ALT 10GM R1	AXT 10GM R1
Remote Tripping		Shunt Trip (SHT)	Under-Voltage Trip (UVT)	
		SHT 10GM DC 24 V	UVT 10GM DC 24 V	
		SHT 10GM DC 100 - 120 V	UVT 10GM DC 100 - 110 V	
		SHT 10GM DC 48 V	UVT 10GM DC 48 V	
		SHT 10GM DC 60 V	UVT 10GM AC 100 - 120 V	
		SHT 10GM DC 125 V	UVT 10GM AC 200 - 230 V	
		SHT 10GM AC 100 - 120 V	UVT 10GM AC 380 - 415 V	
		SHT 10GM AC 200 - 250 V	UVT 10GM AC 440 - 480 V	
		SHT 10GM AC 380 - 480 V	-	

**External Accessory**

		Front Contact (TFG)	Extension (TFH)	
Rotary Handle	Upper Line	TFG 12GM U	TFH 12GM	
	Right Line	TFG 12GM R	TFH 12GM	
	Left Line	TFG 12GM L	TFH 12GM	
Motor Operator <sup>1)</sup>		2 Pole	3 Pole	4 Pole
		-	MOT 12GM DC 24 V	
		-	MOT 12GM AC/DC 110 V	
		-	MOT 12GM AC/DC 240 V	
Terminal Cover	Short	TCF 12GM S2	TCF 12GM S3	TCF 12GM S4
	Long	TCF 12GM L2	TCF 12GM L3	TCF 12GM L4
Locking Device	Padlock	PLD 10GM	PLD 10GM	
	Mechanical Interlock	MIF 12GM 2	MIF 12GM 3	MIF 12GM R4 / MIF 12GM N4
Interpole Barrier		TQQ 10GM 2	TQQ 10GM 3	TQQ 10GM 4
Auxiliary Handle		-		

※ 1) For HGM only.

## Order Code of Accessories

### HGM/HGE Type of Accessory Unit

#### HGM/HGE160, 250

##### Connection Method

		2 Pole	3 Pole	4 Pole
Plug-in	TDM (LINE/LOAD)	-	TDM 25GM P3	-
	TDM (LINE Only)	-	TDM 25GM F3	-
	TDF (LINE Only)	-	-	-
	TDA (1 row)	-	-	-
	TDA (2 rows)	-	-	-
Conn. Block (CBM)		-	CBM 10GM UNIT	-
CBB BLOCK UNIT		-	CBB BLOCK UNIT CBB BLOCK UNIT2C	-
CBB PLATE		-	CBBPLATE 10GM	-
PC MALE		-	PCMALE 25GM	-
Terminal Busbar (TBB)	Straight Busbar	TBB 25GP 2S	TBB 25GP 3S	TBB 25GP 4S
	Spreader Busbar	-	TBB 25GP 3E45	TBB 25GP 4E45
Rear Connection Terminal (RCT)	LINE/LOAD	RCT 25GM F2	RCT 25GM F3	RCT 25GM F4
Cage Terminal (CTB)	inch	CTB 25GM 2S	CTB 25GM 3S	CTB 25GM 4S
	mm	CTB 25GM 2S-MM	CTB 25GM 3S-MM	CTB 25GM 4S-MM
Din Rail Adaptor (DRA)		-	-	-

##### Internal Accessory

	Auxiliary Switch (AUX)	Alarm Switch (ALT)	Auxiliary/Alarm (AXT)
Indication Contacts	AUX 10GM C1	ALT 10GM L1	AXT 10GM L1
	AUX 10GM C2	ALT 10GM R1	AXT 10GM R1
Remote Tripping	Shunt Trip (SHT)		Under-Voltage Trip (UVT)
	SHT 10GM DC 24 V	UVT 10GM DC 24 V	
	SHT 10GM DC 100 - 120 V	UVT 10GM DC 100 - 110 V	
	SHT 10GM DC 48 V	UVT 10GM DC 48 V	
	SHT 10GM DC 60 V	UVT 10GM AC 100 - 120 V	
	SHT 10GM DC 125 V	UVT 10GM AC 200 - 230 V	
	SHT 10GM AC 100 - 120 V	UVT 10GM AC 380 - 415 V	
	SHT 10GM AC 200 - 250 V	UVT 10GM AC 440 - 480 V	
SHT 10GM AC 380 - 480 V	-		

##### External Accessory

		Front Contact (TFG)	Extension (TFH)	
Rotary Handle	Upper Line	TFG 25GM U	TFH 25GM	
	Right Line	TFG 25GM R	TFH 25GM	
	Left Line	TFG 25GM L	TFH 25GM	
Motor Operator <sup>1)</sup>	2 Pole		3 Pole	4 Pole
	-		MOT 25GM DC 24 V	
	-		MOT 25GM AC/DC 110 V	
	-		MOT 25GM AC/DC 240 V	
Terminal Cover	Short	TCF 25GM S3	TCF 25GM S4	
	Long	TCF 25GM L3	TCF 25GM L4	
Locking Device	2 Pole		3 Pole	4 Pole RSTN / NRST
	Padlock	PLD 10GM	PLD 10GM	PLD 10GM
Mechanical Interlock	MIF 25GM 3		MIF 25GM R4 / MIF 25GM N4	
Interpole Barrier	2 Pole		3 Pole	4 Pole
	TQQ 25GM 2		TQQ 25GM 3	TQQ 25GM 4
Auxiliary Handle		-		

※ 1) For HGM only.

## HGM/HGE400

## Connection Method

		2 Pole	3 Pole	4 Pole
Plug-in	TDM (LINE/LOAD)	-	TDM 40GM P3	-
	TDM (LINE Only)	-	TDM 40GM F3	-
Conn. Block (CBM)		-	CBM 10GM UNIT	-
CBB BLOCK UNIT		-	CBB BLOCK UNIT CBB BLOCK UNIT2C	-
CBB PLATE		-	CBBPLATE 40GM	-
PC MALE		-	PCMALE 40GM	-
Terminal Busbar (TBB)	Straight Busbar	TBB 40GM 2S	TBB 40GM 3S	TBB 40GM 4S
	Spreader Busbar	-	TBB 40GM 3E59	TBB 40GM 4E59
Rear Connection Terminal (RCT)	LINE	-	RCT 40GM F3 LINE	RCT 40GM F4 LINE
	LOAD	-	RCT 40GM F3 LOAD	RCT 40GM F4 LOAD
Cage Terminal (CTB)	1 Hole	-	CTB 40GM 3S1H	CTB 40GM 4S1H
	2 Hole	-	CTB 40GM 3S	CTB 40GM 4S

## Internal Accessory

	Auxiliary Switch (AUX)	Alarm Switch (ALT)
Indication Contacts	AUX 40GM C1	ALT 40GM L1
	Shunt Trip (SHT)	Under-Voltage Trip (UVT)
Remote Tripping	SHT 40GM DC 24 V	UVT 40GM DC 24 V
	SHT 40GM DC 100 - 110 V	UVT 40GM DC 100 - 110 V
	SHT 40GM AC 100 - 120 V	UVT 40GM AC 100 - 120 V
	SHT 40GM AC 200 - 230 V	UVT 40GM AC 200 - 230 V
	SHT 40GM AC 380 - 415 V	UVT 40GM AC 380 - 415 V
	SHT 40GM AC 440 - 480 V	UVT 40GM AC 440 - 480 V

## External Accessory

		Front Contact (TFG)	Extension (TFH)	
Rotary Handle	Upper Line	TFG 40GM U	TFH 40GM	
	Right Line	TFG 40GM R	TFH 40GM	
	Left Line	TFG 40GM L	TFH 40GM	
		2 Pole	3 Pole	4 Pole
Motor Operator <sup>1)</sup>		-	MOT 40GM DC 24 V	
		-	MOT 40GM AC/DC 110 V	
		-	MOT 40GM AC/DC 240 V	
Terminal Cover	Short	TCF 40GM S3		TCF 40GM S4
	Long	TCF 40GM L3		TCF 40GM L4
Locking Device	Padlock	PLD 40GM	PLD 40GM	PLD 40GM
	Mechanical Interlock	MIF 40GM 3		MIF 40GM R4 / MIF 40GM N4
Interpole Barrier		TQQ 40GM 2	TQQ 40GM 3	TQQ 40GM 4
Auxiliary Handle		THA 48GM		

※ 1) For HGM only.

## Order Code of Accessories

### HGM/HGE Type of Accessory Unit

#### HGM/HGE630, 800

##### Connection Method

		2 Pole	3 Pole	4 Pole
Plug-in	TDM (LINE/LOAD)	-	TDM 80GM P3	-
	TDM (LINE Only)	-	TDM 80GP F3	-
Conn. Block (CBM)		-	CBM 10GM UNIT	-
CBB BLOCK UNIT		-	CBB BLOCK UNIT CBB BLOCK UNIT2C	-
CBB PLATE		-	CBBPLATE 80GM	-
PC MALE		-	PCMALE 80GM	-
Terminal Busbar (TBB)	Straight Busbar	TBB 63GM 2S (HGM/HGE630) TBB 80GM 2S (HGM/HGE800)	TBB 63GM 3S (HGM/HGE630) TBB 80GM 3S (HGM/HGE800)	TBB 63GM 4S (HGM/HGE630) TBB 80GM 4S (HGM/HGE800)
	Spreader Busbar	-	-	-
Rear Connection Terminal (RCT)	LINE	-	RCT 80GM F3 LINE	RCT 80GM F4 LINE
	LOAD	-	RCT 80GM F3 LOAD	RCT 80GM F4 LOAD
Cage Terminal (CTB)		-	CTB 80GM 3S	CTB 80GM 4S

##### Internal Accessory

		Auxiliary Switch (AUX)	Alarm Switch (ALT)
Indication Contacts		AUX 40GM C1	ALT 40GM L1
		Shunt Trip (SHT)	Under-Voltage Trip (UVT)
		SHT 40GM DC 24 V	UVT 40GM DC 24 V
		SHT 40GM DC 100 - 110 V	UVT 40GM DC 100 - 110 V
Remote Tripping		SHT 40GM AC 100 - 120 V	UVT 40GM AC 100 - 120 V
		SHT 40GM AC 200 - 230 V	UVT 40GM AC 200 - 230 V
		SHT 40GM AC 380 - 415 V	UVT 40GM AC 380 - 415 V
		SHT 40GM AC 440 - 480 V	UVT 40GM AC 440 - 480 V

##### External Accessory

		Front Contact (TFG)	Extension (TFH)	
Rotary Handle	Upper Line	TFG 80GM U	TFH 80GM	
	Right Line	TFG 80GM R	TFH 80GM	
	Left Line	TFG 80GM L	TFH 80GM	
		2 Pole	3 Pole	4 Pole
Motor Operator <sup>1)</sup>		-	MOT 80GM DC 24 V	
		-	MOT 80GM AC/DC 110 V	
		-	MOT 80GM AC/DC 240 V	
Terminal Cover	Short	TCF 80GM S3		TCF 80GM S4
	Long	TCF 80GM L3		TCF 80GM L4
Locking Device	Padlock	PLD 40GM	PLD 40GM	PLD 40GM
	Mechanical Interlock	MIF 80GM 3		MIF 80GM R4 / MIF 80GM N4
Interpole Barrier		TQQ 40GM 2	TQQ 40GM 3	TQQ 40GM 4
Auxiliary Handle		THA 48GM		

※ 1) For HGM only.



## Order Code of Accessories

### HGP Type of Accessory Unit

#### HGP50/125/160D

##### Connection Method

Plug-in		3 Pole	4 Pole
TDM (LINE/LOAD)		TDM 16GP P3	-
TDM (LINE Only)		TDM 16GP F3	-
Conn. Block (CBM)		CBM 10GM UNIT	-
CBB BLOCK UNIT		CBB BLOCK UNIT CBB BLOCK UNIT2C	-
CBB PLATE		CBBPLATE 16GP	-
PC MALE		PCMALE 16GP	-
Terminal Busbar (TBB)	Straight Busbar	-	-
	Spreader Busbar	-	-
Rear Connection Terminal (RCT)	LINE/LOAD	RCT 16GP F3	RCT 16GP F4
Cage Terminal (CTB)		CTB 16GP 3	CTB 16GP 4

##### Internal Accessory

	Auxiliary Switch (AUX)	Alarm Switch (ALT)
Indication Contacts	AUX 16GP R1	ALT 16GP L1
	AUX 16GP R2	-
	Shunt Trip (SHT)	Under-Voltage Trip (UVT)
Remote Tripping	SHT 16GP DC 24 V	UVT 16GP DC 24 V
	SHT 16GP DC 100 - 110 V	UVT 16GP DC 100 - 110 V
	SHT 16GP AC 100 - 120 V	UVT 16GP AC 100 - 120 V
	SHT 16GP AC 200 - 230 V	UVT 16GP AC 200 - 230 V
	SHT 16GP AC 380 - 415 V	UVT 16GP AC 380 - 415 V
	SHT 16GP AC 440 - 480 V	UVT 16GP AC 440 - 480 V

##### External Accessory

Extended (TFH)		Front Contact (TFG)	Extension (TFH)
Rotary Handle	Upper Line	TFG 16GP U	TFH 16GP
	Right Line	TFG 16GP R	TFH 16GP
	Left Line	TFG 16GP L	TFH 16GP
		3 Pole / 4 Pole	
Motor Operator		MOT 16GP DC 24 V	
		MOT 16GP AC/DC 110 V	
		MOT 16GP AC/DC 240 V	
		3 Pole	4 Pole
Terminal Cover	Short	TCF 16GP S3	-
	Long	TCF 16GP L3	TCF 16GP L4
Locking Device	Padlock	PLD 16GP	PLD 16GP
	Mechanical Interlock	MIF 16GP 3	MIF 16GP R4
Interpole Barrier		TQQ 16GP 3	TQQ 16GP 4
Auxiliary Handle		-	

## HGP100/160/250

## Connection Method

Plug-in		3 Pole	4 Pole
TDM (LINE/LOAD)		TDM 25GM P3	-
TDM (LINE Only)		TDM 25GM F3	-
Conn. Block (CBM)		CBM 10GM UNIT	-
CBB BLOCK UNIT		CBB BLOCK UNIT CBB BLOCK UNIT2C	-
CBB PLATE		CBBPLATE 10GM	-
PC MALE		PCMALE 25GP-G	-
Terminal Busbar (TBB)	Straight Busbar	TBB 25GP 3S	TBB 25GP 4S
	Spreader Busbar	TBB 25GP 3E4S	TBB 25GP 4E4S
Rear Connection Terminal (RCT)	LINE/LOAD	RCT 25GP-G F3	RCT 25GP-G F4
Cage Terminal (CTB)		CTB 25GP 3	CTB 25GP 4
Series Busbar (SBB)		SBB 25 GP	SBB 25 GP
Terminal Height Compensation Terminal (STP) <sup>6)</sup>		STP 25GP-G 3T2.5 STP 25GP-G 3T4.5	STP 25GP-G 4T2.5 STP 25GP-G 4T4.5

## Internal Accessory

		Auxiliary Switch (AUX)	Alarm Switch (ALT)
Indication Contacts		AUX 25GP L1 AUX 25GP R2	ALT 25GP L1 ALT 25GP R2
Remote Tripping		Shunt Trip (SHT) SHT 25GP-G DC 24 V SHT 25GP-G DC 100 - 110 V SHT 25GP-G AC 100 - 120 V SHT 25GP-G AC 200 - 230 V SHT 25GP-G AC 380 - 415 V SHT 25GP-G AC 440 - 480 V	Under-Voltage Trip (UVT) UVT 25GP-G DC 24 V UVT 25GP-G DC 100 - 110 V UVT 25GP-G AC 100 - 120 V UVT 25GP-G AC 200 - 230 V UVT 25GP-G AC 380 - 415 V UVT 25GP-G AC 440 - 480 V
Electronic Internal Option	Indicator fault alarm LED	FAL 25GP <sup>1)</sup>	
	DC 24 V POWER CABLE <sup>2)</sup>	PWC 25GP DC 24 V	
	DC 24 V TERMINAL BLOCK <sup>3)</sup>	TB 25GP DC 24 V	
	DC 3.6 V BATTERY	BAT 25GP 10 EA <sup>4)</sup> BAT 25GP 1 EA <sup>5)</sup>	

## External Accessory

		Front Contact (TFG)	Extension (TFH)
Rotary Handle	Upper Line	TFG 25GP U	TFH 25GP
	Right Line	TFG 25GP R	TFH 25GP
	Left Line	TFG 25GP L	TFH 25GP
Motor Operator		3 Pole / 4 Pole MOT 25GP DC 24 V MOT 25GP AC/DC 110 V MOT 25GP AC/DC 240 V	
Terminal Cover	Short	TCF 25GP-G S3	-
	Long	TCF 25GP-G L3	TCF 25GP-G L4
Locking Device	Padlock	PLD 25GP	PLD 25GP
	Mechanical Interlock	MIF 25GP 3	MIF 25GP R4
Interpole Barrier		TQQ 25GP-G 3	TQQ 25GP-G 4
Auxiliary Handle		-	-
Electronic External Option	TEST KIT	TESTKIT 25GP	
	NFC MODULE	NFCMD 25GP	

※ 1) FAL option for Electronic MCCB replace installation space of SHT/UVT 1 + AUX1 in MCCB internal accessory diagram of 81 page.

2) Applicable to ETU "A", "E" type only, length : 1.5 m

3) Applicable to ETU "A", "E" type only

4) 10 EA plastic wrapped

5) 1 EA plastic wrapped

6) Match of terminal height between old and new model (T2.5 : height 2.5 mm / T4.5 : height 4.5 mm, 3 Pole 3 EA / 4 Pole 4 EA)

7) 1 EA

## Order Code of Accessories

### HGP Type of Accessory Unit

#### HGP400/630

##### Connection Method

Plug-in		3 Pole	4 Pole
TDM (LINE/LOAD)		TDM 63GP P3	-
TDM (LINE Only)		TDM 63GP F3	-
Conn. Block (CBM)		CBM 10GM UNIT	-
CBB BLOCK UNIT		CBB BLOCK UNIT CBB BLOCK UNIT2C	-
CBB PLATE		CBBPLATE 63GP	-
PC MALE		PCMALE 63GP	-
Terminal Busbar (TBB)	Straight Busbar	TBB 63GP 3S	TBB 63GP 4S
	Spreader Busbar	TBB 63GP 3E61.5	TBB 63GP 4E61.5
Rear Connection Terminal (RCT)	LINE	RCT 63GP F3 LINE	RCT 63GP F4 LINE
	LOAD	RCT 63GP F3 LOAD	RCT 63GP F4 LOAD
Cage Terminal (CTB)		CTB 63GP 3	CTB 63GP 4
Series Busbar (SBB)		SBB 63 GP	SBB 63 GP

##### Internal Accessory

		Auxiliary Switch (AUX)	Alarm Switch (ALT)
Indication Contacts		AUX 63GP L1	ALT 63GP R1
		AUX 63GP L2	-
		AUX 63GP L3	-
Remote Tripping		Shunt Trip (SHT)	Under-Voltage Trip (UVT)
		SHT 63GP DC 24 V	UVT 63GP DC 24 V
		SHT 63GP DC 100 - 110 V	UVT 63GP DC 100 - 110 V
		SHT 63GP AC 100 - 120 V	UVT 63GP AC 100 - 120 V
		SHT 63GP AC 200 - 230 V	UVT 63GP AC 200 - 230 V
		SHT 63GP AC 380 - 415 V	UVT 63GP AC 380 - 415 V
Electronic Internal Option	Indicator fault alarm LED		FAL 25GP <sup>1)</sup>
	DC 24 V POWER CABLE <sup>2)</sup>		PWC 25GP DC 24 V
	DC 24 V TERMINAL BLOCK <sup>3)</sup>		TB 25GP DC 24 V
	DC 3.6 V BATTERY		BAT 25GP 10 EA <sup>4)</sup>
			BAT 25GP 1 EA <sup>5)</sup>

##### External Accessory

		Front Contact (TFG)	Extension (TFH)
Rotary Handle	Upper Line	TFG 63GP U	TFH 63GP
	Right Line	TFG 63GP R	TFH 63GP
	Left Line	TFG 63GP L	TFH 63GP
Motor Operator		3 Pole/ 4 Pole	
		MOT 63GP DC 24 V	
		MOT 63GP AC/DC 110 V	
	MOT 63GP AC/DC 240 V		
Terminal Cover	Short	TCF 63GP S3	-
	Long	TCF 63GP L3	TCF 63GP L4
Locking Device	Padlock	PLD 63GP	PLD 63GP
	Mechanical Interlock	MIF 63GP 3	MIF 63GP R4
Interpole Barrier		TQQ 63GP 3	TQQ 63GP 4
Auxiliary Handle		THA 63GP	THA 63GP
Electronic External Option	TEST KIT	TESTKIT 25GP	
	NFC MODULE	NFCMD 25GP	

※ 1) FAL option for Electronic MCCB replace installation space of SHT/UVT 1 + AUX1 in MCCB internal accessory diagram of 81 page.

2) Applicable to ETU "A", "E" type only, length : 1.5 m

3) Applicable to ETU "A", "E" type only

4) 10 Ea plastic wrapped

5) 1 Ea plastic wrapped



## HGP800

### Connection Method

Plug-in		3극	4극
TDM (LINE/LOAD)		TDM 80GP P3	-
TDM (LINE Only)		TDM 80GP F3	-
Conn. Block (CBM)		CBM 10GM UNIT	-
CBB BLOCK UNIT		CBB BLOCK UNIT CBB BLOCK UNIT2C	-
CBB PLATE		CBBPLATE 80GP	-
PC MALE		PCMALE 80GP	-
Terminal Busbar (TBB)	Straight Busbar	TBB 80GP 3S	TBB 80GP 4S
	Spreader Busbar	-	-
Rear Connection Terminal (RCT)	LINE	RCT 80GP F3 LINE	RCT 80GP F4 LINE
	LOAD	RCT 80GP F3 LOAD	RCT 80GP F4 LOAD
Cage Terminal (CTB)		CTB 80GP 3	CTB 80GP 4
Series Busbar (SBB)		SBB 80 GP	SBB 80 GP

### Internal Accessory

		Auxiliary Switch (AUX)	Alarm Switch (ALT)
Indication Contacts		AUX 63GP L1	ALT 63GP R1
		AUX 63GP L2	-
		AUX 63GP L3	-
Remote Tripping		Shunt Trip (SHT)	Under-Voltage Trip (UVT)
		SHT 63GP DC 24 V	UVT 63GP DC 24 V
		SHT 63GP DC 100 - 110 V	UVT 63GP DC 100 - 110 V
		SHT 63GP AC 100 - 120 V	UVT 63GP AC 100 - 120 V
		SHT 63GP AC 200 - 230 V	UVT 63GP AC 200 - 230 V
		SHT 63GP AC 380 - 415 V	UVT 63GP AC 380 - 415 V
Electronic Internal Option	Indicator fault alarm LED		FAL 25GP <sup>1)</sup>
	DC 24 V POWER CABLE <sup>2)</sup>		PWC 25GP DC 24 V
	DC 24 V TERMINAL BLOCK <sup>3)</sup>		TB 25GP DC 24 V
	DC 3.6 V BATTERY		BAT 25GP 10 EA <sup>4)</sup>
			BAT 25GP 1 EA <sup>5)</sup>

### External Accessory

		Front Contact (TFG)	Extension (TFH)
Rotary Handle	Upper Line	TFG 80GP U	TFH 80GP
	Right Line	TFG 80GP R	TFH 80GP
	Left Line	TFG 80GP L	TFH 80GP
Motor Operator		3 Pole / 4 Pole	
		MOT 80GP DC 24 V	
		MOT 80GP AC/DC 110 V	
Terminal Cover	Short	TCF 80GP S3	-
	Long	TCF 80GP L3	TCF 80GP L4
Locking Device	Padlock	PLD 80GP	PLD 80GP
	Mechanical Interlock	MIF 80GP 3	MIF 80GP R4
Interpole Barrier		TQQ 80GP 3	TQQ 80GP 4
Auxiliary Handle		THA 80GP	THA 80GP
Electronic External Option	TEST KIT		TESTKIT 25GP
	NFC MODULE		NFCMD 25GP

※ 1) FAL option for Electronic MCCB replace installation space of SHT/UVT 1 + AUX1 in MCCB internal accessory diagram of 81 page.

2) Applicable to ETU "A", "E" type only, length: 1.5 m

3) Applicable to ETU "A", "E" type only

4) 10 EA plastic wrapped

5) 1 EA plastic wrapped

# Handling and Maintenance Inspection

## Storage and Transportation

### Storage Precaution

- | Ambient Temperature | - 20 ~ + 60 °C
- | Altitude | Below 1,000 m above sea level
- | Relative Humidity | Within 45 % ~ 85 %

The surrounding environment may affect the insulation function and Endurance of the molded case and earth leakage circuit breakers so the environment condition for usage must accurately be checked before application.



- Do not store in places with corrosive gas  
Do not leave it around gas containing sulfurous gas or sulfur or ammonia gas and others.



- Do not store in places with high humidity for a long period of time



- Do not leave under direct sunlight for a long period of time.



- Avoid places with a lot of dust  
Do not store in exposed places and use cover or packing material to prevent dust from piling up on the circuit breaker.



- Avoid storage in high or low temperature  
Storage temperature must be maintained between - 20 °C ~ + 60 °C.  
(Exceptionally, the HGM/HGP-MCCB in the original packing can be stored up to - 40 °C.)

### Transportation Precautions

#### ▲ Caution

- Do not apply impact during transportation. Dropping or applying strong impact may cause defect.
- Do not handle while holding the circuit breaker's accessory or the external plug-in wire of the accessory. It may cause injury in the handler or a malfunction of the circuit breaker.

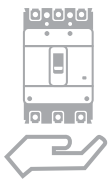

- Hold the main unit of the circuit breaker during transportation  
Do not handle while holding the external guide line of the accessory or the terminal bar.



- Pay attention when handling metal accessories  
Sharp planes or edges in the metal accessory may cause injury.



- Do not apply impact during transportation  
Dropping or applying strong impact may cause defect.

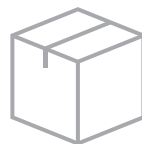

- Pay attention to the packaging of the circuit breaker before transportation  
Inappropriate packaging may cause damage in the circuit breaker during transportation.

## Installation

As for the detailed dimension of each part required for installation, refer to the external structure.

### ⚠ Caution

- Electrical works shall only be conducted by a person qualified for electrical works.
- For wiring works, the upper circuit breaker must be cut off (OFF) and execute the work after checking that it is not charged.
- In case of disconnecting cable or terminal bar, tighten the terminal screw firmly at the standard tightening torque.  
In case the terminal screw is tightened loosely, it may cause damage and fire due to overheating.
- Strictly insulate up to the circuit breaker's portion with terminal barrier, insulating tube, insulating tape and others between bare conductors with regards to the front connection of the circuit breaker.  
In case it is not insulated, it may cause short circuit.

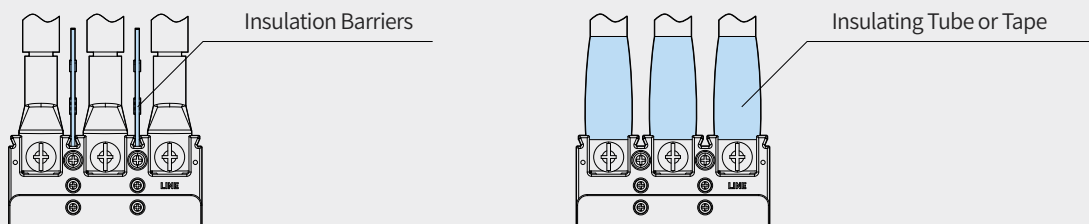

- Secure sufficient arc space (Insulation distance) so that the arc gas discharge outlet is not blocked.  
In case this discharge outlet is blocked, the current may not be blocked.
- Do not install the circuit breaker in abnormal environment such as high temperature, high humidity, dust, corrosive gas, vibration, impact and others. It may cause fire or abnormal trip.
- Install so that foreign substances (Metal powder, concrete powder etc.), rainwater and others do not enter the circuit breaker.  
Such foreign substances in the circuit breaker may cause fire or malfunction.
- In case of 4 pole circuit breaker, the neutral wire of 3 phase 4 wire must be connected to the N phase (Right end part of the circuit breaker).
- When mounting the product, the live part (LINE) signal must be connected to the live part and the load part (LOAD) signal must be connected to the load part. Wrong connection may cause damage in product and electric shock.
- In case the insulation barrier is not mounted between the circuit breaker terminals, it may cause secondary short-circuit accidents so it must be used.

# Handling and Maintenance Inspection

## Installation

### Installation Precautions

- Install the circuit breaker in a place that satisfies the following environment conditions

Installing the circuit breaker in places and environment other than the following may cause malfunction of circuit breaker, fire and others.

- Ambient temperature should be within -5 °C to +50 °C degrees. (The default MCCB based on 40 °C ambient temperature. 50 °C products have a separate code and temperature correction table. If the ambient temperature is - 40 °C to - 5 °C, the HGM/HGP MCCB can be used under limited conditions.)
- Relative humidity to be within 45 ~ 85 %
- Excessive vibration or impact to be avoided
- True height to be below 2,000 m
- To be used in an environment without excessive water vapor, oil vapor, smoke, dust, alkaline, corrosive material and others
- To avoid direct sunlight



- Arc gas exhaust hole must not be blocked  
It may drop the breaking capacity.



- Attention to be paid to dust, metal fragments and others  
After installation, protection cover and covers to be covered during work



- The insulation plate attached to the bottom of the circuit breaker must not be separated  
It may destroy insulation and drop the insulation performance.

### Connection Precautions



- When fastening the terminal screw, it should be fastened according to the specified torque  
Incomplete fastening of terminal screw may cause overheating so each terminal screw must be fastened completely according to the specified torque. In addition, excessive fastening torque may cause damage in the terminal screw and the circuit breaker case.



- Use of lubricant at the terminal screw part is prohibited  
Lubricant reduces the friction of the screw, causing the screw to loosen, ultimately leading to an increase in temperature.



- Exposed conductor must be insulated  
Insulating tube or insulating tape must be used for complete insulation between the bare conductors of the MCCB.  
In case the terminals are not insulated, it may cause secondary short-circuit during short-circuit accidents.

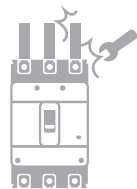

- Stud must not be deformed  
Excessive force must not be applied to the stud at the conductor connecting part of the rear connection type.  
In addition, stud must not be deformed during wiring.



- In case of 4 pole circuit breaker, the neutral wire of 3 phase 4 wire must be connected to the N phase.  
It may not function in overcurrent which may cause fire.



- The conductor must be fixed firmly on a flat state.  
As for the connecting conductor, electromagnetic force between conductors is generated by extremely big fault current so it must be fixed firmly.

## Connection Precautions

The following table is the impact electromagnetic force generated by fault current.

### Impact Electromagnetic Force per 1 m Conductor

Regulated Short-Circuit Current kA (Power Factor)	Electromagnetic Force (In Case of 3 Phase Short Circuit) N (kgf)	
	10 cm Conductor Interval	20 cm Conductor Interval
10 (0.4)	490 (50)	245 (25)
18 (0.3)	1,863 (190)	932 (95)
25 (0.2)	4,412 (450)	2,206 (225)
35 (0.23)	8,630 (880)	4,315 (440)
42 (0.2)	12,455 (1,270)	6,277 (635)
50 (0.2)	17,652 (1,800)	8,826 (900)
65 (0.2)	29,910 (3,050)	14,955 (1,525)
85 (0.2)	51,190 (5,220)	25,595 (2,510)
100 (0.2)	70,804 (7,220)	35,402 (3,610)
125 (0.2)	110,815 (11,300)	55,408 (5,650)

- **Contact surface must be clean**

Dust and others must be removed from the contact surface to prevent increase in connection resistance at the contact surface.

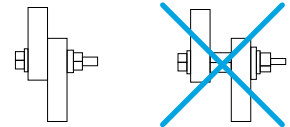

- **Conductor must be connected so that it has direct contact with the contact surface**

Do not use bolt or nut between the contact surfaces of the conductor.  
If there is no direct contact between conductors, it may cause increase in temperature and fire.

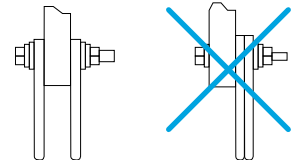

- **Do not overlap the conductors**

When numerous conductors are connected to the terminal bar, do not overlap and assemble.  
Assemble at both ends of the terminal bar.

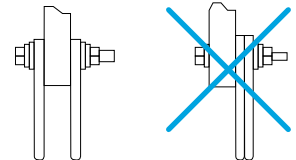

## Maintenance Inspection

### Initial Inspection

- Residues of steel plate, grinded materials of the wire, other conductor's foreign substances and others must not be left around the terminal of the circuit breaker
- There must be no crack and damage in the cover and base
- The fastening status of the terminal fastening part must be checked
- Check must be made if the rated voltage and breaking capacity of the circuit breaker are correct
- When the insulation resistance is measured using a 500 V insulation-resistance tester, it must be above 5 MΩ

### Withstand Voltage

Main Circuit		Auxiliary Circuit or Control Circuit <sup>1)</sup>	
Rated Insulation Voltage	Test Voltage (Effective Value of Interchange)	Rated Insulation Voltage of Operational Circuit	Test Voltage (Effective Value of Interchange)
$U_i \leq 300$ V	2,000 V for 1 min	$U_{is} \leq 60$ V	1,000 V for 1 min
$300 < U_i \leq 600$ V	2,500 V for 1 min	$60$ V < $U_{is} \leq 600$ V	$2 \cdot U_{is}$ 1,000 V (최소 1,500 V) for 1 min

※ Based on the above mentioned table, do not conduct withstand voltage test above it.

1) Between terminal and grounding

# Handling and Maintenance Inspection

## Installation

### Regular Inspection

Inspection shall be conducted once in 1 month before/after the commencement of the equipment operation in order to maintain the performance of the circuit breaker and to prevent unexpected accidents. After that, regular inspection is required depending on the environment.

### Standard of Inspection Period

Extent	Environment	Standard of Inspection Period
Standard Usage State	Clean and dry state of air	Less than 10 years after installation - Once in 2 ~ 3 years
		More than 10 years after installation - Once a year
		More than 15 years after installation - Once in 6 months
	Place without corrosive gas even though there is dust inside	Less than 10 years after installation - Once a year
		More than 10 years after installation - Once in 6 months
		More than 15 years after installation - Once a month
Bad Environment	Place containing sulfurous acid, hydrogen sulfide, salinity, vapor and others	Less than 5 years after installation - Once in 6 months
		More than 5 years after installation - Once a year
	Places with specially more corrosive gas	Once a month

### Regular Inspection Item

Inspection Item	Procedure	Countermeasure
Tightening of Terminal Screw	<ul style="list-style-type: none"> <li>Inspect tightening of terminal screw, conductor connecting screw</li> </ul>	<ul style="list-style-type: none"> <li>Tighten according to the specified torque</li> <li>Ensure that it is not tightened excessively</li> </ul>
Dust and Foreign Substance	<ul style="list-style-type: none"> <li>Check for foreign substance such as dust on the circuit breaker's surface, especially the top of the live part. There must be no dust or foreign substance to secure insulation distance</li> </ul>	<ul style="list-style-type: none"> <li>Remove dust, foreign substance and others using cloth with clean surface types (Do not use thinner or detergent)</li> </ul>
Damage in Mold Case	<ul style="list-style-type: none"> <li>Check for damage or crack on the circuit breaker's cover and base</li> </ul>	<ul style="list-style-type: none"> <li>Replace circuit breaker</li> </ul>
Arc Exhaust Hole	<ul style="list-style-type: none"> <li>Check for pollution in the arc exhaust hole</li> </ul>	<ul style="list-style-type: none"> <li>If there are burns or excessive pollution due to melted metal particles and others, replace the circuit breaker</li> </ul>
Switch Operation	<ul style="list-style-type: none"> <li>If the circuit breaker was maintained at closed state at normal times, operate the switch multiple times. Friction caused by hardened grease and others will be reduced and the contact resistance can be stabilized</li> <li>Press the trip button to trip the circuit breaker multiple times</li> </ul>	<ul style="list-style-type: none"> <li>If there is a problem in the switch operation of the circuit breaker, replace or contact the nearest store</li> <li>If the specified limit value of the switch operation has exceeded, replace</li> </ul>
	<ul style="list-style-type: none"> <li>If internal options were installed in mccb, the options should be checked when mccb is in switch operation</li> </ul>	<ul style="list-style-type: none"> <li>If there is a internal option problem in the swtich operation, replace</li> </ul>
Discoloration of Terminal Part	<ul style="list-style-type: none"> <li>Check for severe discoloration in the terminal part or conductor part</li> <li>If there is severe discoloration in the copper conductor or silver coated part, check the insulation performance caused by thermal damage</li> </ul>	<ul style="list-style-type: none"> <li>Slight discoloration in the silver coated part is not a problem. If there is a problem in insulation due to thermal damage, replace the circuit breaker</li> </ul>
Insulation Resistance	<ul style="list-style-type: none"> <li>Separate all conductors connected to the circuit breaker and measure the insulation resistance between the poles, terminals and groundings</li> </ul>	<ul style="list-style-type: none"> <li>If the insulation resistance is not more than 5 MΩ, replace</li> </ul>

### Inspection and Processing after Blocking Fault Current

In case the circuit breaker has blocked the fault current, determine whether it can be re-used or whether it has to be replaced with a new product depending on the size of the fault current.

- In case the arc exhaust hole is not polluted or there are no other abnormalities, it can be reused.
- In case there is pollution such as dark burns around the arc exhaust hole and in case the insulation resistance is above 5 MΩ, there is no dielectric breakdown when the specified withstand voltage is applied and in case there is no excessive temperature increase in the terminal part, it can be reused.
- If there are burns at the handle part, severe pollution around the arc exhaust hole, melted metal particles and others, replace the circuit breaker immediately.

## Countermeasures with Regards to Abnormal Phenomenon





In case there is abnormal phenomenon during the use of circuit breakers, take appropriate action according to the following table.

Type of Abnormality	Phenomenon	Assumed Cause	Action to be Taken
Abnormal Heating	Heating at terminal part	• Loose terminal screw, conductor connecting screw	Re-tighten according to the specified torque
		• Increased resistance of contact	Replace circuit breaker
	Damage in insulation material at terminal part	• Loose terminal screw, conductor connecting screw • Defect in contact between circuit breaker's terminal and terminal bar or cable lugs due to loose screw tightening and interference caused by foreign substance	Replace circuit breaker
Defect in Current Flow	Abnormal heating in the circuit breaker's external case	• Increased resistance of contact	Replace circuit breaker
		• Loosening at the internal connection part	
		• Increased current density due to disconnection	
Does Not Function	Abnormal voltage at load side	• Big consumption at contact	Replace circuit breaker
		• Foreign substance between contacts	
		• Fusing at conductive part (Excessive opening/closing and corrosion due to corrosive gas)	
Does Not Function	ON does not function	• No reset in trip state	ON after reset
		• Damage in trip mechanism due to excessive opening/closing	Replace circuit breaker
		• Demagnetized state of under-voltage trip device	Apply specified voltage
	OFF does not function	• Fusing at contact	Replace circuit breaker
		• Demagnetized state of under-voltage trip device	Apply specified voltage
	RESET does not function	• Bimetal has not been cooled sufficiently	Reset after sufficient cooling
		• Corrosion or deformation of bimetal • Abnormality in mechanism • Can't be used due to excessive opening/closing • Damage in mechanism due to excessive breaking current	Replace circuit breaker
Frequent Breaking	Trip under rated current	• High ambient temperature (Above 40 °C)	Lower the ambient temperature using wind and others
		• Abnormal heating due to loosening of screw at terminal part	Re-tighten according to the specified torque
		• Internal heating at the circuit breaker	Replace circuit breaker
	Trip in running current	• In case the cross sectional area of connecting conductor is smaller than the regulation	Change the connecting conductor or change the circuit breaker's rated current
		• Trip in running inrush current • Trip during switching at Y-Δ operation • Trip during switching in reversible operation	Change the instantaneous trip current setting or replace with circuit breaker with bigger rated current
Overcurrent does Not Function	Does not function above specified operational current	• Trip in big running current	Replace with circuit breaker with bigger rated current
		• Trip in long running current	Replace with circuit breaker with bigger rated current
		• Short circuit between motor layer • Wrong connection of SHT/UVT's operational circuit	Repair or replace motor Inspect wiring
Abnormality in Accessory	Abnormal operation of shunt trip device (SHT)	• When current limiting breaking of upper fuse or cooperation with upper circuit breaker is low	Review cooperation again
		• When the ambient temperature is significantly low	Check the compensating current
		• Inappropriate rated current	Check the rated current
	Abnormal operation of under-voltage trip device (UVT)	• Abnormal voltage of operational circuit	Check the rated voltage
		• Does not function due to voltage drop in operational circuit	Maintain the rated voltage
		• Coil damage due to difference in the coil's rated voltage, non-operation of damage prevention switch and others	Replace accessory
Abnormal operation of auxiliary switch (AUX) and alarm switch (ALT)	Abnormal operation of auxiliary switch (AUX) and alarm switch (ALT)	• Defect in mechanism	Replace accessory
		• Difference in voltage used	Check the rated voltage
		• Damage in UVT controller	Replace and check disconnection
Abnormal operation of auxiliary switch (AUX) and alarm switch (ALT)	Abnormal operation of auxiliary switch (AUX) and alarm switch (ALT)	• Contact damage due to excessive micro switch rating	Replace and check the micro switch load
		• Defect in mechanism	Replace and repair accessory

## Current Status of Acquired Standards

### Approvals & Certificates

#### MCCB

Type of Certification		Approvals				Certificates
Type of Standard	Safety Certificate	KS	IEC	GB	DEKRA	
Mark						
Testing Institute	KETI	KS	CE	GB 1984	DEKRA	
Certification Country	Korea	Korea	Europe	China	Netherlands	
HGM30	E	●	●	●	●	
	S	●	●	●	●	
HGM50	E	●	●	●	●	
	S	●	●	●	●	
	H	●	●	●	●	
	L	●	●	●	●	
HGM60	E	●	●	●	●	
	S	●	●	●	●	
	H	●	●	●	●	
	L	●	●	●	●	
HGM100	E	●	●	●	●	
	S	●	●	●	●	
	H	●	●	●	●	
	L	●	●	●	●	
HGM125	E	●	●	●	●	
	S	●	●	●	●	
	H	●	●	●	●	
	L	●	●	●	●	
HGM160	E	●	●	●	●	
	S	●	●	●	●	
	H	●	●	●	●	
	L	●	●	●	●	
HGM250	E	●	●	●	●	
	S	●	●	●	●	
	H	●	●	●	●	
	L	●	●	●	●	
HGM400	E	●	●	●	●	
	S	●	●	●	●	
	H	●	●	●	●	
	L	●	●	●	●	
HGM630	E	●	●	●	●	
	S	●	●	●	●	
	H	●	●	●	●	
	L	●	●	●	●	
HGM800	S	●	●	●	●	
	H	●	●	●	●	
	L	●	●	●	●	









## Current Status of Acquired Standards





### Approvals & Certificates

#### ELCB

Type of Certification	Approvals			Certificates
Type of Standard	Safety Certificate	KS	IEC	IEC
Mark				
Testing Institute	KETI	KS	CE	DEKRA
Certification Country	Korea	Korea	Europe	Netherlands
HGE30	E	●	●	●
	S	●	●	●
HGE50	E	●	●	●
	S	●	●	●
	H	●	●	●
	L	●	●	●
HGE60	E	●	●	●
	S	●	●	●
	H	●	●	●
	L	●	●	●
HGE100	E	●	●	●
	S	●	●	●
	H	●	●	●
	L	●	●	●
HGE125	E	●	●	●
	S	●	●	●
	H	●	●	●
	L	●	●	●
HGE160	E	●	●	●
	S	●	●	●
	H	●	●	●
	L	●	●	●
HGE250	E	●	●	●
	S	●	●	●
	H	●	●	●
	L	●	●	●
HGE400	E	●	●	
	S	●	●	
	H	●	●	
	L	●	●	
HGE630	E	●	●	
	S	●	●	
	H	●	●	
	L	●	●	
HGE800	S	●	●	
	H	●	●	
	L	●	●	

## Approvals & Certificates

### MCCB

Type of Certification	Approvals				Certificates
Type of Standard	Safety Certificate	KS	IEC	GB	IEC
Mark					
Testing Institute	KETI	KS	CE	GB	DEKRA
Certification Country	Korea	Korea	Europe	China	Netherlands
HGP50D	F*		●	●	●
	S	●	●	●	●
	H	●	●	●	●
	X	●	●	●	●
HGP125D	F*		●	●	●
	S	●	●	●	●
	H	●	●	●	●
	X	●	●	●	●
HGP160D	F*		●	●	●
	S	●	●	●	●
	H	●	●	●	●
	X	●	●	●	●
HGP100	F*		●	●	●
	S	●	●	●	●
	H	●	●	●	●
	X	●	●	●	●
HGP160	F*		●	●	●
	S	●	●	●	●
	H	●	●	●	●
	X	●	●	●	●
HGP250	F*		●	●	●
	S	●	●	●	●
	H	●	●	●	●
	X	●	●	●	●
HGP400	F*		●	●	●
	S	●	●	●	●
	H	●	●	●	●
	X	●	●	●	●
HGP630	F*		●	●	●
	S	●	●	●	●
	H	●	●	●	●
	X	●	●	●	●
HGP800	F*		●	●	●
	S	●	●	●	●
	H	●	●	●	●
	X	●	●	●	●









※ \* F type is for overseas sales.

※ Please refer to the certificate for specifications of certified products.

## Current Status of Acquired Standards

### Approvals & Marine Certificates

#### MCCB

Type of Certification		Vessel							
Type of Standard	Korea	U.K	France	U.S.A	Germany	Italy	Japan	Russia	
Mark									
Testing Institute	KR	LR	BV	ABS	DNV-GL	RINA	NK	RMRS	
Certification Country	Korea	U.K	France	USA	Germany	Italy	Japan	Russia	
HGP50D	F*	●	●	●	●	●	●	●	
	S	●	●	●	●	●	●	●	
	H	●	●	●	●	●	●	●	
	X	●	●	●	●	●	●	●	
HGP125D	F*	●	●	●	●	●	●	●	
	S	●	●	●	●	●	●	●	
	H	●	●	●	●	●	●	●	
	X	●	●	●	●	●	●	●	
HGP160D	F*	●	●	●	●	●	●	●	
	S	●	●	●	●	●	●	●	
	H	●	●	●	●	●	●	●	
	X	●	●	●	●	●	●	●	
HGP100	F*	●	●	●	●	●	●	●	
	S	●	●	●	●	●	●	●	
	H	●	●	●	●	●	●	●	
	X	●	●	●	●	●	●	●	
HGP160	F*	●	●	●	●	●	●	●	
	S	●	●	●	●	●	●	●	
	H	●	●	●	●	●	●	●	
	X	●	●	●	●	●	●	●	
HGP250	F*	●	●	●	●	●	●	●	
	S	●	●	●	●	●	●	●	
	H	●	●	●	●	●	●	●	
	X	●	●	●	●	●	●	●	
HGP400	F*	●	●	●	●	●	●	●	
	S	●	●	●	●	●	●	●	
	H	●	●	●	●	●	●	●	
	X	●	●	●	●	●	●	●	
HGP630	F*	●	●	●	●	●	●	●	
	S	●	●	●	●	●	●	●	
	H	●	●	●	●	●	●	●	
	X	●	●	●	●	●	●	●	
HGP800	F*	●	●	●	●	●	●	●	
	S	●	●	●	●	●	●	●	
	H	●	●	●	●	●	●	●	
	X	●	●	●	●	●	●	●	

※ \*F type is for overseas sales.





**HYUNDAI ELECTRIC**

---

**Korea**

---

<b>Head Office</b>	Hyundai Bldg, 75, Yulgok-ro, Jongno-gu, Seoul, Korea		
<b>Sales Office</b>	5th Floor 55, Bundang-ro, Bundang-gu, Seongnam-si, Gyeonggi-do, Korea	Tel : +82-31-8006-6780, 6786	Fax : +82-31-8006-6629
<b>Factories</b>	700, Bangeojinsunhwan-doro, Dong-gu, Ulsan, Korea 223, Sapyong-ro, Nam-gu, Ulsan, Korea (Seonam)		
<b>R&amp;D Center</b>	17-10, Mabuk-ro 240beon-gil, Giheung-gu, Yongin-si, Gyeonggi-do, Korea		

---

**Branch Offices**

---

<b>Atlanta</b>	6100 Atlantic Boulevard, 2nd FL., Norcross, GA30071, U.S.A	Tel : +1-678-823-7839	Fax : +1-678-823-7553
<b>Osaka</b>	5th Floor Nagahori Plaza Bldg. 2-4-8 Minami Senba, Chuo-ku, Osaka 542-0081, Japan	Tel : +81-6-6261-5766~7	Fax : +81-6-6261-5818
<b>Moscow</b>	World Trade Center, Ent.3, #703, Krasnopresnenskaya Nab.12, Moscow, 123610, Russia	Tel : +7-495-258-1381	
<b>Dubai</b>	Unit 205, Emaar Square Building No.4 Sheikh Zayed Road, Dubai 252458, U.A.E	Tel : +971-4-425-7995	Fax : +971-4-425-7996
<b>Frankfurt</b>	Mendelssohn strabe 55-59 Frankfurt 60325, Germany	Tel : +49-69-4699-4988	
<b>Bangkok</b>	19th Floor, Unit 1908, Sathorn Square Office Tower, 98 North Sathorn Road, Silom, Bangrak, Bangkok 10500, Thailand	Tel : +66-02-115-7920	Fax : +66-2-115-7898

---